



نفخر باستحواذنا علي رضا عملائنا علي مدار اربعة عقود من الزمان . لقد تمكنا من نيل ثقة
. عملائنا من خلال الجودة ومصداقية شركتنا

اربعون عاماً من النجاح بفضل موظفينا والتزامهم بتحقيق النتائج بالطريقة السليمة من خلال
تحمل المسؤولية والتنفيذ الممتاز واستخدام التقنيات الابداعية . تسعى شركتنا دائما للتطوير
واستحداث منتجات جديدة تمكنها من الاستجابة السريعة لمتطلبات عملائنا واستغلال الفرص
. الجديدة من اجل تحقيق النمو المربح

يتركز انتاجنا الرئيسي علي الحديد الزهر الرمادي والحديد القابل للسحب والإطالة (الحديد المرن)

نقوم بانتاج المنتجات الصحية وتصريف مياه الامطار مثل اغطية فتحات غرف التفتيش ,
المصبغات (الشبك) ، صناديق الخدمة ، فتحات التنظيف ، مصبغات الاشجار وأحواض التجميع
لحقول النفط لشركة ارمكو الخ . كذلك ننتج صفايات الارضيات والأسطح . الي جانب
المنتجات اعلاه ننتج قطع غيار الشاحنات (spoke wheel,hub,adaptor,wheel hub)
سبائك الفولاذ الخفيف , فولاذ المنجنيز ،حديد الكروم الزهر ، وسبائك الالمنيوم والنحاس الي
جانب الصب لدينا وحدة تصنيع قادرة علي انتاج منتجات الفولاذ المطاوع .

يعتمد نظام الجودة لدينا علي مقاييس ايزو 9001-2015 في مراحل الانتاج واجراءات الجوده
والتغليف والشحن وخدمات العملاء . سواء كان في التحليل الكيميائي للمعادن والرمل المستخدم او
اختبار قوة الشد ومواصفات وابعاد منتجاتنا النهائية . من خلال التركيز علي الحلول الابداعية
للمشكلات

نصنع الجودة وأفضل خدمات التوصيل وأسعار التعبئة في السوق , سيستمر مسبك الرياض في
. سعيه لتحقيق الكفاءة وتطوير منتجات مستقبلية

40 year's

RIYADH FOUNDRY

We are proud as we look back for over the past four decades to provide the satisfaction to our customers. We have gained the trust of our customers through the quality and reliability of our company.

Our **40 years** of success is driven by our people and their commitment to get results right way by operating responsibility , executing with excellence , applying innovative technologies company is constantly developing and new product will able to respond quickly to customer requirements and capturing new opportunities for profitable growth.

Our main range of production in grey iron and ductile iron under outdoor drainage. **We provide sanitary and storm drainage products like Manhole Covers, Gratings , Surface boxes, Cleanouts , Tree Grates and Catch Basin for Aramco oil field** etc. . Within the indoor drainage we produce floor and roof drains. Apart from above production **we also produce Truck parts like Spoke wheel , Hub, Adaptor, Wheel Hub etc. moreover we manufacture Low alloy steel, Manganese steel, Chrome cast iron, Aluminum brass and Copper brass.** Beside the Casting , company has Fabrication unit capable of producing a Mild Steel products.

Our quality control system is based on **ISO9001:2015** standard throughout production – in progress quality, Packing, Dispatching and Customer service. Whether initiating a chemical analysis of the metal and sand or testing the tensile strength and dimensional specification of our final output.

By focusing on problems – solving innovations, we made quality and the best delivery and fill rates in the markets, Riyadh Foundry will continue to thrive with efficiency and develop the product of the future.

40 year's

RIYADH FOUNDRY

QUALITY POLICY

Riyadh foundry company committed to customer satisfaction by providing good casting products on time and complying to applicable standards, specifications in a safe manner.

We shall strive for continual improvement in quality system in all spheres of our operations.

We shall Endeavour achieving leadership through timely delivery of quality products at competitive price and by employee involvement.

OUR MISSION STATEMENT

We, the Riyadh Foundry Company committed to becoming the region's leading manufacturer of Construction, Industrial and Engineering Casting in Ferrous and Non Ferrous.

The "**Mission**" of our Company in continued business expansion is striving always to improve upon the Quality of what we do. To this effect "Riyadh Foundry" have embarked upon an Ongoing Business Improvement Program based upon the standard ISO 9001:2015 .

Moreover through continuous product development, application of advanced technology and customer service, we are fully committed to providing our customers with high grade quality casting with effective price.

OUR TECHNICAL ADVISORY AND SERVICE

Riyadh Foundry Company has been producing quality casting in Riyadh, Saudi Arabia, for **40 years**. The commitment to quality and technical support / after delivery service that since **1976**, is still the capability behind Riyadh Foundry Company being realized as the Quality Product and Technical service leader in the Casting Industry.

40 year's

RIYADH FOUNDRY

Riyadh Foundry recognizes its commitment to provide all interested parties with appropriate policies that ensure adequate control over its activities.

Riyadh Foundry committed to comply, as a minimum, with all legal, regulatory and other requirements and to provide its employee resources to implement maintain and improve its management systems. These management systems are intended to identify, eliminate, reduce and contain risks to the operations of the business and ensure that objectives are to achieve these aims.

The management of Riyadh Foundry are committed to the concept of continual improvement and have implemented an effective integrated management system to meet the requirement of an ISO9001-Quality and ISO 14001-Environmental Management Standards.

To achieve this commitment Riyadh Foundry will endeavor to:-

- > Comply with applicable legal and other requirements to which the company subscribes.
- > Actively work towards preventing pollution and continually improving our environmental performance.
- > Providing and maintaining plant, equipment and machinery and ensuring safe storage and use of substances.
- > Ensuring the all polices and business practices are communicated to all employees and to others working on plant, through appropriate briefing and training.
- > Regularly reviewing business performance and continually improving through the setting, achieving and exceeding quality and environmental objectives and targets which are linked to customer satisfaction and, are cascaded throughout Riyadh Foundry
- > Ensure the Integrated Management is documented, implemented and maintained.
- > Carry out internal audit and management Review to measures the effectiveness of our system and provide sources of recommendations for our continual improvement.

These policies are communicated throughout the organization to its employees, customers, suppliers and other interested parties . This policy will be reviewed when circumstances require, ensuring it remains relevant to all Riyadh Foundry operation and services.

By Management of Riyadh Foundry,

40 year's

RIYADH FOUNDRY

GLOSSARY

- Clear opening** : The nominal unobstructed access opening in a frame, neglecting minor intrusions such as the corner or side fillets of some particular frames.
- Keyholes** : Key holes closed or open provided for lifting the cover. At least two keyways provided in each complete cover and one in each segment for a double triangular cover.
- Chambered keyhole** : (Closed) Chambered lifting keyholes encapsulated to reduce the ingress of sand / silt etc.
- Plain seated** : Non sealed, butt jointed contact the bearing surface between a cover and frame
- Machined seated** : The bearing surface plain sealed between cover and frame machined to assure the non rocking and the tight seating of cover against the escape of fluids / gases at within certain limit.
- Hinge** : Hinge which does not allow a cover or grating to be removed.
- Prising slots** : Slot in cover edge to allow initial cover easement by use of prising bar.
- Single seal** : Vertical "tongue in groove" relationship between a cover edge and frame.
- Double seal** : Duplicate vertical single seal " tongue in groove" relationship between a cover edge and frame.
- GRP Plate** : Glass reinforced plastic plate double seal usually located under a cover to provide additional protection against the ingress of sand.
- Recessed Covers** : Cover recessed to allow the insertion of chosen material usually to match the surrounding area.
- Safety grid** : A fabricated steel, stainless steel, or cast iron ductile grid housed under a cover when installed to catch an accidentally dropped things.
- Double Traingular** : Covers comprising two triangular elements for the purpose of providing stable seating under load (non- rock).
- Holding down bolts** : Provision is made in the frame of certain units for the insertion of bolts for positive fixing to the bed.
- Slide out** : Cover removable by sliding action rather than vertical lift.
- Watertight** : Proof against the passage of surface water of minimal depth and at atmospheric pressure.

- General** : Casting shall be manufactured true to pattern , parts shall fit together in a satisfactory manner and it shall be smooth and well cleaned.
- Bearing surface** : All circular manhole frames and covers are furnished with cast bearing surfaces unless if furnished with machined horizontal bearing surfaces, noted within or acknowledged at the time of order. All square or rectangular units are furnished with as cast bearing surfaces unless otherwise noted at the time of order.
- Weights** : Weights are not shown in this catalogue .Over all shape and function, rather than weight , are the major consideration to be used in evaluating castings. Focus on basic dimensions and application when creating your casting specifications and specify RIYADH FOUNDRY Product Code. Current weights are always available from RIYADH FOUNDRY COMPANY when required.
- Submittals** : Manufacture's shop drawings shall be submitted to the contractor's, / client / consultant for approval prior to manufacture. The contractor shall retain the right to reject the casting product if not conforming to this specification and or approved submitted drawings.
- Dimensions / units** : Dimensions given in the tables are taken from design drawing at the time of made drawings and or existing patterns, details of overall sizes may vary slightly according to the specific pattern or tool in use at the time of manufacture.
- Metric units** : Metric sizes stated are approximate, and also when need to convert inch to mm, a conversion rate of 1" - 25 mm has commonly been used for clear opening and depths .
- Area is expressed in square centimetres and wheel loading is expressed in metric tons.
- Dim.Tolerances** : As cast dimensions may vary maximum shrinkage possessed by $\pm 1.0\text{mm}$ for every 100mm, mainly effect to over base, clear opening, depth and cover or grate .
- Installation** : Cast iron is a fairly rigid material, but large size of cast iron frame and cover are not themselves completely rigid. It is essential ,therefore, that frames are properly bedded and levelled during installation. also it need to make frame anchoring to concrete to prevent lateral movement of the frame and cover rocking
- The time of maintenance to make sure that bearing surface of frame smoothly cleaned against the ingress of sand / silt etc. Before cover put back to frame prevent cover rocking.
- In the case of Airtight manhole cover and frame, watertight manhole cover and frame , pressure - tight manhole cover and frame , special design with flat or round rubber gasket , it must be taken special care and to maintain every time when remove the cover for maintenance.

40 year's

RIYADH FOUNDRY COMPANY

- Interchangeability** : Although batches of castings are produced from the same pattern, it does not follow that covers or grates will be interchangeable. Cast Iron, Ductile Covers manufactured to carefully controlled sizes, and standard covers are normally interchangeable subject to steel frame or cast iron frame are properly bedded and leveled during installation. However, always be made to the relevant drawings and fixing instructions before installation.
- Surface finish** : All solid top cast iron covers are manufactured with a non-slip surface to provide adequate grip, the design of which may vary according to pattern in use.
- Lettering** : Provision is made for covers to be lettered to identify services etc. or customers own specific lettering can be incorporated in to the surface design on request. it is generally easier to include up to a maximum of 4 cm. length of letter. Although more can often be accommodated depending on the size and model required.
- Test certificates** : Riyadh foundry can be provided test certificate against request or it will be issued with presence of contractor, consultant or client or third party witnessed certificate accordingly.
- Protective coating** : Riyadh foundry, castings are supplied black bitumen paint unless otherwise requested. Casting can be supplied with black epoxy coated, zinc protective coating if required. Steel fabricated items are available finish with black epoxy paint, or hot dip-galvanized according to BS. 729 .

This should be clearly stated in enquiries and when placed the orders.

- Precautions taken** : **Secure by locking device frames and covers together.**

This catalog contains many items that have neoprene flat rubber gasket or round rubber gasket .The Specifiers and users must realize that these gaskets compress underload and can release this compressed energy rapidly. It may have a tendency to loosing the rubber gasket, dislodge or damage the rubber. Consider for each maintenance and inspection make sure that rubber gaskets are remain tight fixing and functional.

Rubber Gasketed frames and covers.

Riyadh foundry catalogue includes many items provided covers locking to frames using hexagonal bolts, pentagonal bolt or other fastening device. Users must realize that bolt and their accessories may have a tendency to work loose over a period of time due to traffic vibrations, temperature cycles etc. and that routine inspection and maintenance schedules should be added to assure these locking device remain tight and functional.

- Note** : Items shown in the catalogue is only dimensions, shape, loading and features. Number of checkers and other Ribs dimension and Location are may vary than where shown in the table or drawing

1: LOADING AND DESIGN STANDARD

WE ARE PRODUCING ALL OUR COVERS, FRAMES, DRAINAGE PRODUCTS ACCORDING TO CATEGORIES OF RANGING FROM LIGHT DUTY TO EXTRA HEAVY DUTY.

STANDARD SPECIFICATION

Class	Standard BSEN 124 : 1994 (British Standard)	Standard SASO SSA 413 : 1985 (Saudi Arabian Standard Org)	Application in Appropriate Areas	Images
A15 / LIGHT DUTY	1.5 TONS / 15 KN	1.5 TONS / 15 KN	FOR USE IN PEDESTRIAN AREA	
B125 / MEDIUM DUTY	12.5 TONS / 125 KN	15 TONS / 150 KN	FOR USE IN FOOT WAYS, PEDESTRIAN AREAS AND CAR PARKS	
C250 / MEDIUM TO HEAVY DUTY	25 TONS / 250 KN	--	FOR USE IN KERB SIDE CHANNELS OF ROADS AND CAR PARKS	
D400 / HEAVY DUTY	40 TONS / 400 KN	40 TONS / 400 KN	FOR USE IN CARRIAGE WAYS, HARD SHOULDERS AND PARKING AREAS	
E600 / SPECIAL DUTY	60 TONS / 600 KN	60 TONS / 600 KN	FOR USE IN HIGH WHEEL LOADS AREAS LIKE DOCKS AND AIRCRAFT PAVEMENT	
F900 / EXTRA HEAVY DUTY	90 TONS / 900 KN	--	FOR USE IN VERY HIGH WHEEL LOADS AREAS AIRCRAFT PAVEMENTS	

ALL ABOVE TEST LOADING WILL BE APPLICABLE FOR GREY CAST IRON AND DUCTILE CAST IRON COVERS

METHOD OF TESTING SPECIFICATION FOLLOWS AND EQUIVALENT TO SASO SSA 412 - 1985

2: MATERIAL STANDARD

GREY CAST IRON :-

Grey cast iron or flake graphite and to the following standard and grades :

- . ASTM A 48 / A 48M - 03
Grades 25 - B, 30 - B, 35 - B
- . Equaling to BSEN 1561 : 1997
Grades EN - GJL - 250, EN - GJL - 300, EN - GJL - 350

Grades 40 - B, 45 - B will provide by the request of customer

DUCTILE CAST IRON :-

Ductile cast iron or spheroid graphite iron (SG) to the following standard and grades :

- . ASTM A 536 - 84
Grades 60 - 40 - 18, 65 - 45 - 12, 80 - 55 - 06, 80 - 60 - 03
- . Equaling to BSEN 1563 : 1997
Grades EN - GJS - 400 - 18, EN - GJS - 400 - 15, EN - GJS - 450 - 10, EN - GJS - 500 - 7,
EN - GJS - 600 - 3

Grades 60 - 42 - 10, 70 - 50 - 05 will provide by the request of customer

40 year's

RIYADH FOUNDRY

TABLE OF CONTENTS

Description	Page Nos.
I. GENERAL	
➤ QUALITY POLICY	7 to 7
➤ OUR MISSION STATEMENT	7 to 7
➤ OUR TECHNICAL ADVISORY AND SERVICE	7 to 7
➤ INTEGERATED MANAGEMENT SYSTEM POLICY	9 to 9
➤ TECHNICAL GUIDELINE (GLOSSARY)	11 to 15
➤ SELECTING THE RIGHT PRODUCTS	17 to 19
➤ TABLE OF CONTENT	21 to 23
2. SOLIDTOP COVERS AND FRAMES	
➤ Circular Covers and Frames	25 to 45
➤ Circular Covers and Square Frames	47 to 60
➤ Square Covers and Frames	61 to 85
➤ Rectangular Single and Multiple Covers and Frames	87 to 103
3. RECESSED TOP COVERS AND FRAMES	105 to 122
(Including Single and Multiple)	
4. COVERS WITH MILD STEEL ANGLE FRAMES	123 to 137
➤ Mild Steel Frames with Cast Iron Single and Multiple Covers (Solid Top)	
5. GULLY GRATINGS AND FRAMES	139 to 177
➤ Gully Grates and Frames	
➤ Grating with Steel Frame	
➤ Kerb Gully Grates	
➤ Multiple Grates and Frames	
6. CHANNEL GRATINGS	179 to 198
7. TREE GRATINGS	199 to 209
8. SUFACE BOX	211 to 225
9. WATER METER BOX	227 to 232

TABLE OF CONTENTS

Description	Page Nos.
10. APPROVALS	233 to 257
<ul style="list-style-type: none">▶ Saudi Aramco▶ Telecommunications▶ Saudi Telecom Company▶ Jordan Telecommunications▶ Telecommunication Accessories	
MINISTRY OF WATER AND ELECTRICITY	259 to 267
<ul style="list-style-type: none">▶ Sewer Project - Riyadh▶ Sewer Project - Eastern Province▶ Water Project - Riyadh	
MUNICIPALITY	269 to 273
MINISTRY OF EDUCATION	277 to 280
<ul style="list-style-type: none">▶ Ministry of Education (Boys School)▶ Ministry of Education (Girls School)	
11. DRAINAGE PRODUCTS	287 to 300
<ul style="list-style-type: none">▶ Roof Drains▶ Scupper Drains▶ Floor Drains▶ Grates▶ Vent Cap▶ Gutter Drains▶ Cleanouts	
12. STEEL FABRICATED PRODUCTS	303 to 318
<ul style="list-style-type: none">▶ Access Ladder▶ Manhole Accessories▶ Solid Top Covers and Frames (Single,Trench Type and Multiple)▶ Recessed Top Covers and Frames (Single,Trench Type and Multiple)▶ Grates and Frames (Single,Trench Type and Multiple)	
13. INDEX	319

40 year's

RIYADH FOUNDRY



CIRCULAR COVERS AND FRAMES



Light, Medium and Heavy Duty Grey Cast Iron Cover's and Frames

Features:-

- Lifting Bar
- Single Seal

Options :-

- Closed Keyholes / Open Keyhole
- Plain Seated

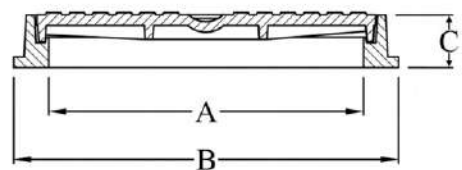
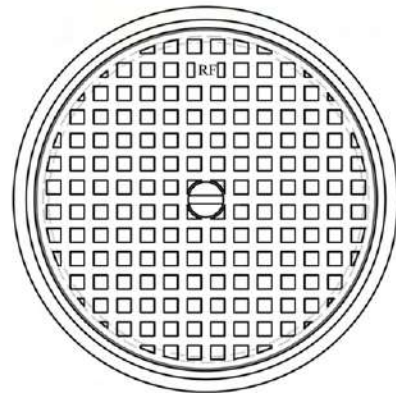

Product Code	Clear Opening A (mm)	Over Base B (mm)	Depth C (mm)	Loading (TONS)	Specifications
MC - 045 (LD)	450 Ø	550 Ø	50	1.5	B S - EN 124
MC - 045 (MD)	450 Ø	550 Ø	75	12.5	B S - EN 124
MC - 045 (HD)	450 Ø	550 Ø	75	40	B S - EN 124
MC - 050 (LD)	500 Ø	650 Ø	50	1.5	B S - EN 124
MC - 050 (MD)	500 Ø	650 Ø	75	12.5	B S - EN 124
MC - 050 (HD)	500 Ø	650 Ø	75	40	B S - EN 124

Extra Heavy Duty Ductile Cast Iron Covers and Frames

Features:-

- Register
- Closed Keyholes
- Single Seal

Options :-

- Rubber Gasket

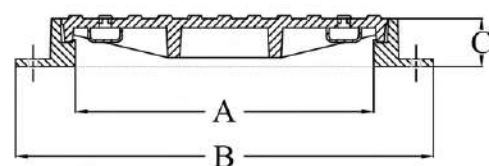
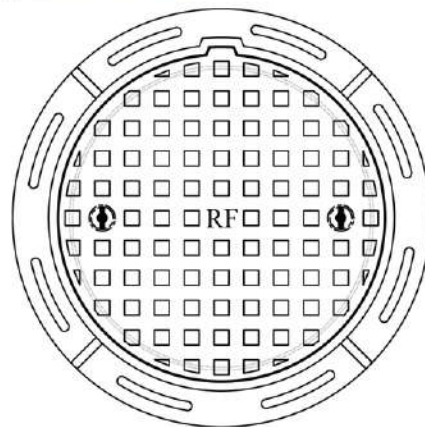

Product Code	Clear Opening A (mm)	Over Base B (mm)	Depth C (mm)	Loading (TONS)	Specifications
MC - 050 EDI (HD)	500 Ø	700 Ø	80	60	B S - EN 124

Heavy Duty Grey Cast Iron Covers & Frames

Features:-

- Two Prising Slots
- Four Holes for Anchoring
- Four Air Vent Holes

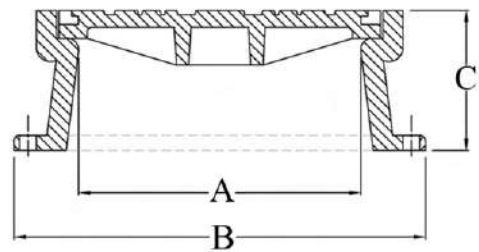
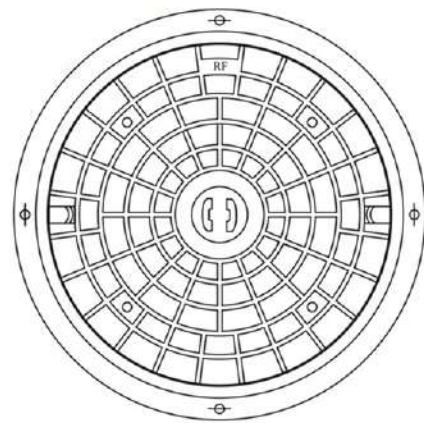

Product Code	Clear Opening A (mm)	Over Base B (mm)	Depth C (mm)	Loading (TONS)	Specifications
MC - 120 AR1 (HD)	550Ø	850Ø	250	40	BS - EN 124

Heavy & Extra Heavy Duty Grey Cast Iron Covers and Frames

MC - 051 AF - COVER AND FRAME USED FOR AIRCRAFT PAVEMENT

Features:-

- Closed Keyholes
- Cover Secured to frame by stainless steel Bolts
- Provided with Rubber Gasket
- Water Resistance

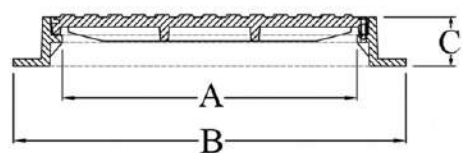
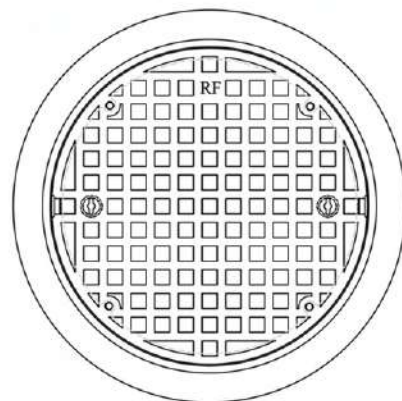

Product Code	Clear Opening A (mm)	Over Base B (mm)	Depth C (mm)	Loading (TONS)	Specifications
MC - 051 A (HD)	600Ø	800Ø	100	40	BS - EN 124
MC - 051 AE (HD)	600Ø	800Ø	100	60	BS - EN 124
MC - 051 AF (HD)	600Ø	800Ø	100	90	BS - EN 124

Light, Medium and Heavy Duty Grey Cast Iron Covers and Frames

Features:-

- Single Seal
- Register
- Closed Keyholes
- Two Prising Slots
- Two Locking Device
- MC - 100 LD not Single Seal

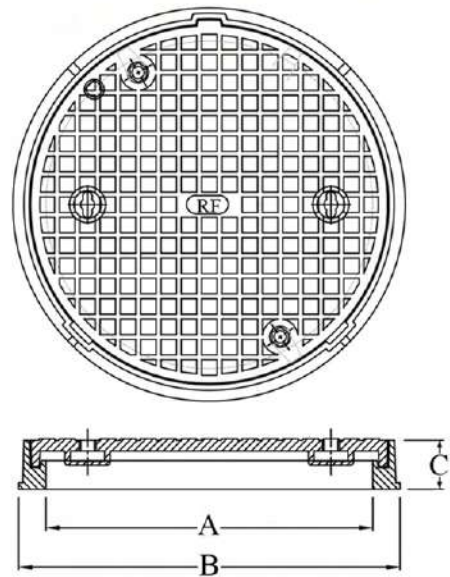

Product Code	Clear Opening A (mm)	Over Base B (mm)	Depth C (mm)	Loading (TONS)	Specifications
MC - 100 (LD)	600 Ø	720 Ø	90	1.5	BS - EN 124
MC - 100 R M1 (MD)	600 Ø	720 Ø	90	12.5	BS - EN 124
MC - 101 (MD)	600 Ø	735 Ø	95	12.5	BS - EN 124
MC - 101 DSAR3 (HD)	600 Ø	850 Ø	100	40	BS - EN 124
MC - 101 R1 (MD)	600 Ø	735 Ø	95	15	BS - EN 124
MC - 101 R2 M (HD)	600 Ø	735 Ø	100	25	BS - EN 124

Medium & Heavy Duty Ductile Cast Iron Covers and Frames

Features:-

- Register
- Closed Keyholes
- Single Seal
- Two Prising Slots
- MC - 100 R M1 DI (HD) With 2 Locking Device

Options:-

- Rubber Gasket

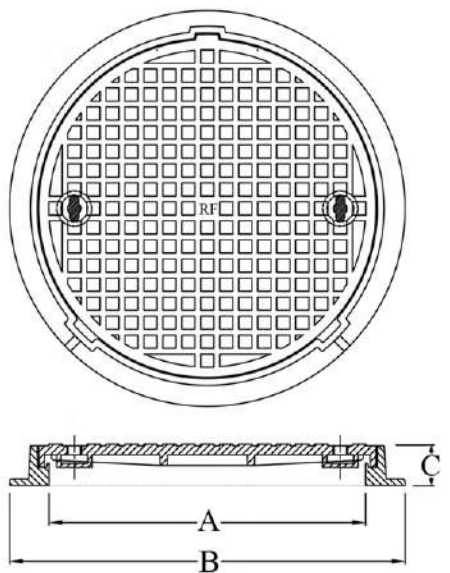

Product Code	Clear Opening A (mm)	Over Base B (mm)	Depth C (mm)	Loading (TONS)	Specifications
MC - 100 RDIM (MD)	600 Ø	750 Ø	75	12.5	BS - EN 124
MC - 100 RDIM (HD)	600 Ø	750 Ø	75	40	BS - EN 124
MC - 100 RM1 DI (HD)	600 Ø	720 Ø	75	40	BS - EN 124

Medium & Heavy Duty Ductile Cast Iron Covers and Frames

Features:-

- Closed Keyholes
- Two Prising Slots
- Two Locking Device
- Register

Options:-

- Rubber Gasket

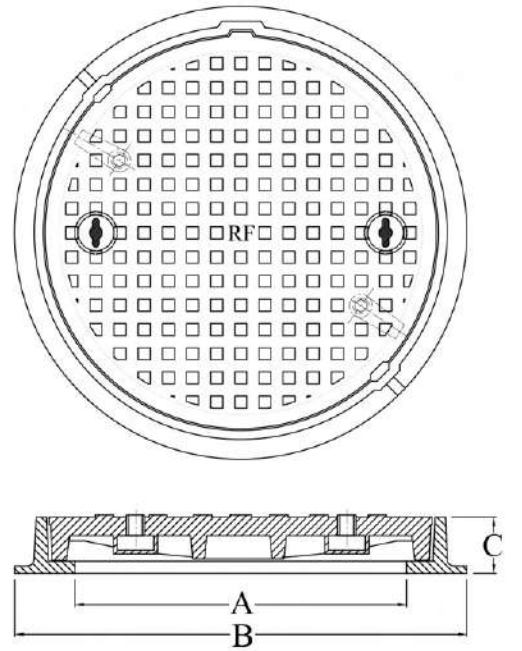

Product Code	Clear Opening A (mm)	Over Base B (mm)	Depth C (mm)	Loading (TONS)	Specifications
MC - 101 A D I (MD)	600 Ø	750 Ø	100	12.5	B S - EN 124
MC - 101 A D I (HD)	600 Ø	750 Ø	100	40	B S - EN 124

Medium & Heavy Duty Grey Cast Iron cover and Frames

Features:-

- Closed Keyholes
- Prising Slots
- Locking Bolts
- Register

Options:-

- Single Seal

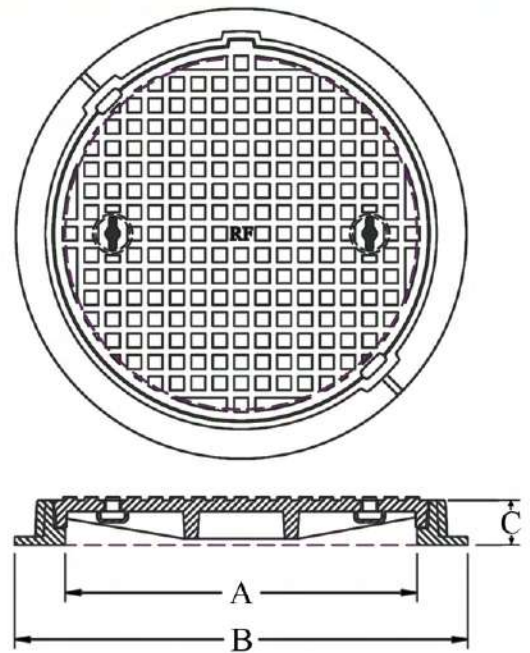

Product Code	Clear Opening A (mm)	Over Base B (mm)	Depth C (mm)	Loading (TONS)	Specifications
MC - 105 (HD)	600 Ø	780 Ø	100	40	B S - EN 124
MC - 105 (MD)	600 Ø	780 Ø	100	12.5	B S - EN 124

Extra Heavy Duty Ductile Cast Iron Covers & Frames

Features:-

- Register
- Closed Keyholes
- Two Prising Slots
- Two Locking Device

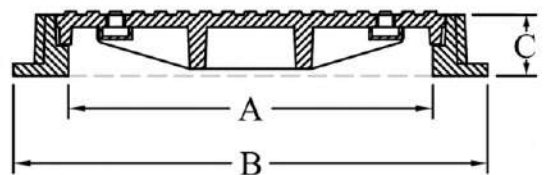
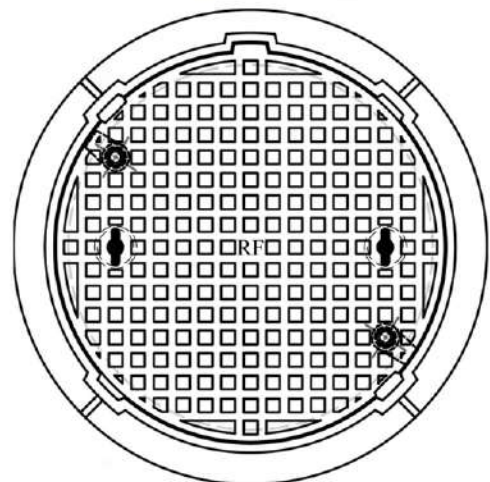

Product Code	Clear Opening A (mm)	Over Base B (mm)	Depth C (mm)	Loading (TONS)	Specifications
MC - 105 DI E (HD)	600 Ø	780 Ø	100	60	BS - EN 124
MC - 105 DI F (HD)	600 Ø	780 Ø	100	90	BS - EN 124

Medium and Heavy Duty Ductile Cast Iron Covers & Frames

Features:-

- Closed Keyholes
- Two Locking Device
- Foundation Bolt Slots
- Two Prising Slots
- MC - 106 DI (MD) in Single Seal

Options:-

- With GRP Plate
- Rubber Gasket

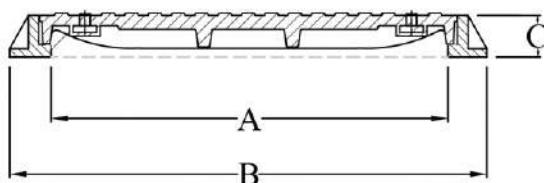
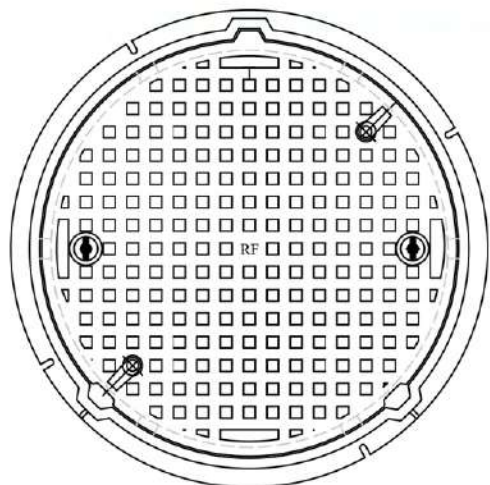

Product Code	Clear Opening A (mm)	Over Base B (mm)	Depth C (mm)	Loading (TONS)	Specifications
MC - 106 DI (MD)	600 Ø	750 Ø	75	12.5	BS - EN 124
MC - 106 DI (HD)	600 Ø	750 Ø	75	40	BS - EN 124



Heavy Duty Ductile Iron Hinge Covers and Frames

Features:-

- One Closed Keyholes
- Cover Hinged to Frame
- Cover secured to the Frame

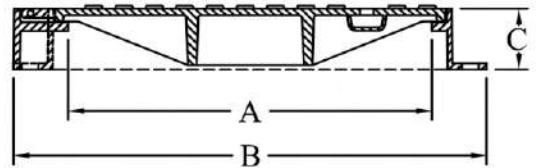
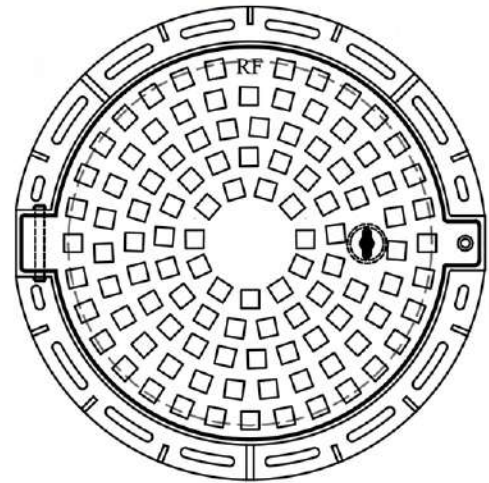

Product Code	Clear Opening A (mm)	Over Base B (mm)	Depth C (mm)	Loading (TONS)	Specifications
MC - 106 DI AR1 (HD)	600 Ø	780 Ø	100	40	BS - EN 124
MC - 106 DI AR2 (HD)	600 Ø	780 Ø	150	40	BS - EN 124

Heavy Duty Ductile Iron Hinge Covers and Frames

Features:-

- One Closed Key Hole
- Cover Hinged to Frame
- Cover secured to the Frame

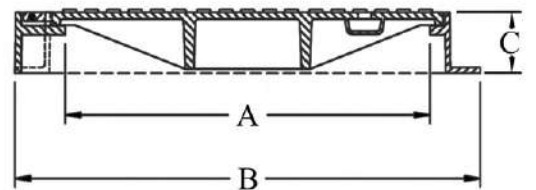
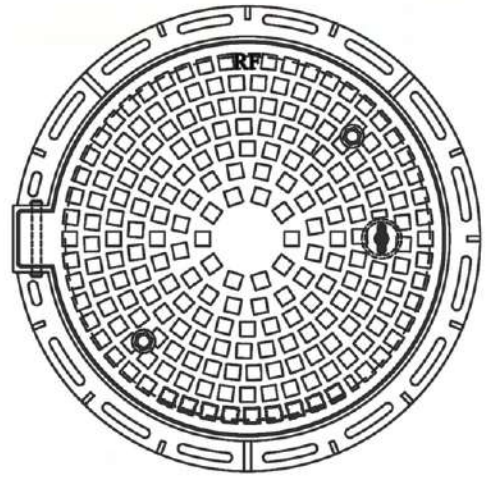

Product Code	Clear Opening A (mm)	Over Base B (mm)	Depth C (mm)	Loading (TONS)	Specifications
MC - 106 DI A R1 N (HD)	600 Ø	765 Ø	100	40	BS - EN 124
MC - 106 DI A R2 N (HD)	600 Ø	765 Ø	150	40	BS - EN 124
MC - 106 DI A R3 N (HD)	600 Ø	810 Ø	150	40	BS - EN 124

Ductile Cast Iron Heavy Duty Hinge Covers & Frames

Features:-

- One Closed Keyhole
- Cover Hinged to Frame
- Cover secured to the Frame

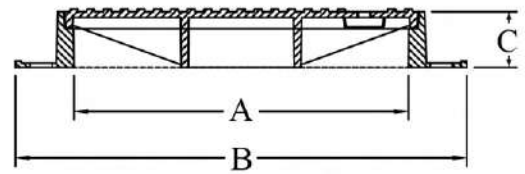
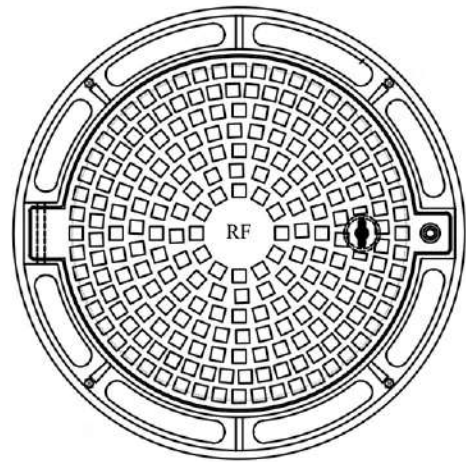

Product Code	Clear Opening A (mm)	Over Base B (mm)	Depth C (mm)	Loading (TONS)	Specifications
MC - 106 AR3 H (HD)	600 Ø	810 Ø	100	40	BS - EN 124

Heavy Duty Cast Iron Double Hinged Cover & Frames

Features:-

- One Closed Keyhole
- Double Hinge Stainless Steel
- Stainless Steel Locking Bolts
- Foundation Holes For Anchoring

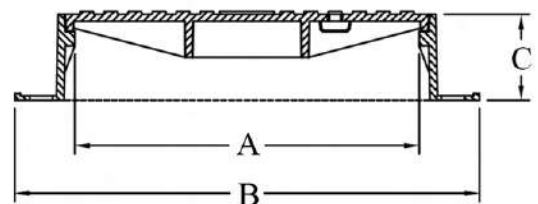
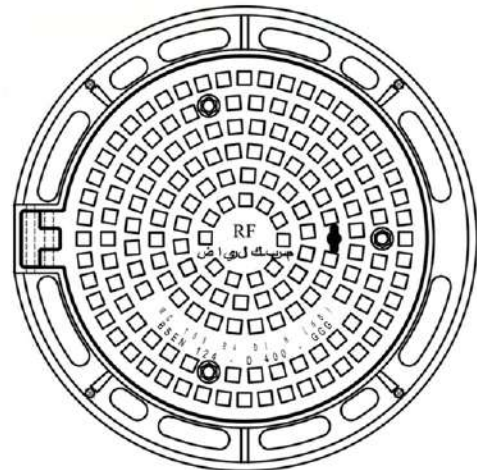

Product Code	Clear Opening A (mm)	Over Base B (mm)	Depth C (mm)	Loading (TONS)	Specifications
MC - 109 - 120 DI H (HD)	600 Ø	810 Ø	150	40	BS - EN 124
MC - 109 - R4 DI H (HD)	600 Ø	810 Ø	150	40	BS - EN 124

Heavy Duty Grey Cast Iron Double Hinge Cover & Frames

Features:-

- One Closed Keyhole
- Double Hinge
- Cover Secured to the Frame
- Foundation Holes For Anchoring

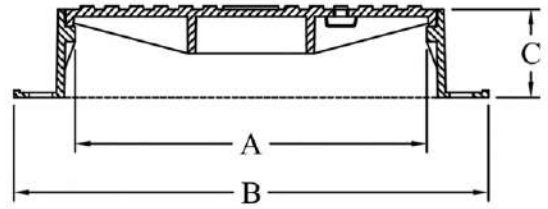
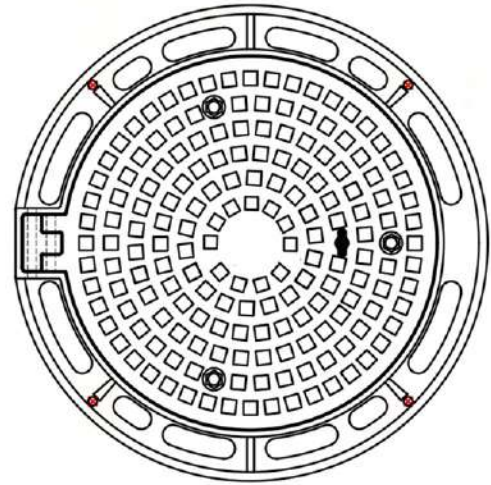

Product Code	Clear Opening A (mm)	Over Base B (mm)	Depth C (mm)	Loading (TONS)	Specifications
MC - 109 R4 - H (HD)	600 Ø	810 Ø	150	40	BS - EN 124

Medium and Heavy Duty Hinged Ductile Cast Iron Covers & Frames

Features:-

- One Lifting Bar
- Cover Hinged to Frame
- Foundation Holes For Anchoring



SEWER PROJECT (JEDDAH)

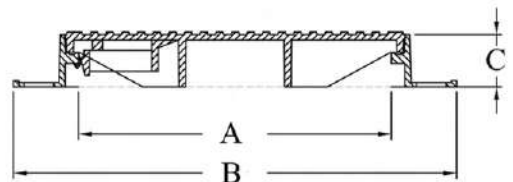
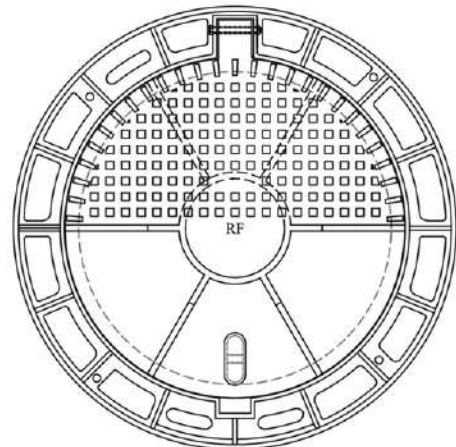

Product Code	Clear Opening A (mm)	Over Base B (mm)	Depth C (mm)	Loading (TONS)	Specifications
MC - 109 DI (MD)	600 Ø	850 Ø	100	12.5	BS - EN 124
MC - 109 DI (HD)	600 Ø	850 Ø	100	40	BS - EN 124

Medium & Heavy Duty Grey Cast Iron Cover & Frames

Features:-

- Register
- Open Keyholes
- Four Vent Holes
- Round Rubber Gasket
- Three Prising Slots

Options:-

- Closed Keyholes
- Without Vent Holes
- With Twelve Vent Holes
- Mud Trap

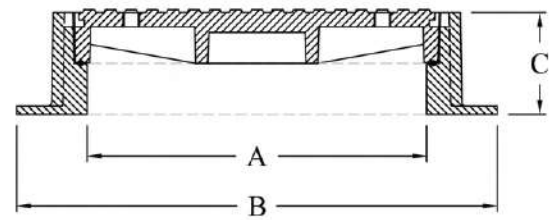
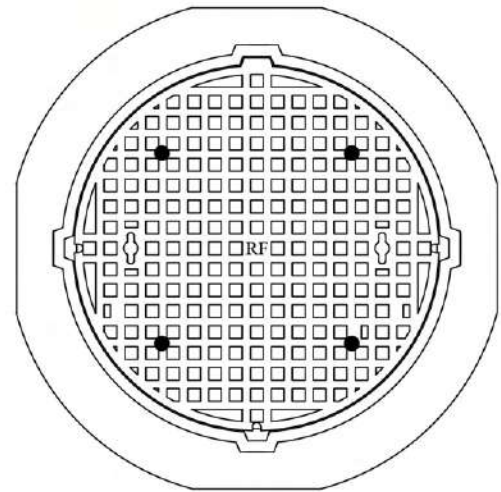

Product Code	Clear Opening A (mm)	Over Base B (mm)	Depth C (mm)	Loading (TONS)	Specifications
MC - 110 (MD)	600 Ø	850 Ø	180	12.5	BS - EN 124
MC - 110 (HD)	600 Ø	850 Ø	180	40	BS - EN 124

Heavy Duty Ductile Cast Iron Hinged Covers & Frames

Features:-

- Cover Hinged
- Closed Keyholes
- Air tight
- Rubber Gasket
- Foundation Holes For Anchoring
- Cover Secured to Frame

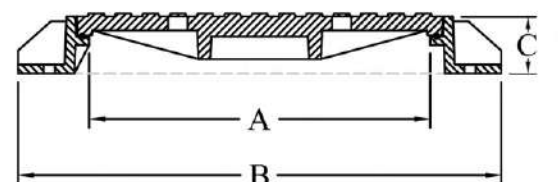
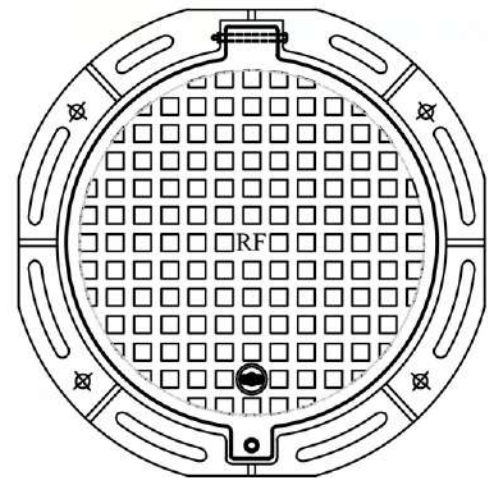

Product Code	Clear Opening A (mm)	Over Base B (mm)	Depth C (mm)	Loading (TONS)	Specifications
MC - 110 R1 HDI (HD)	600 Ø	820 Ø	100	40	BS - EN 124



Heavy Duty Ductile Cast Iron Covers & Frames

Features:-

- Register
- Open Keyholes
- Two Stainless Steel Locking Device
- Three Prising Slots
- Foundation Holes For Anchoring

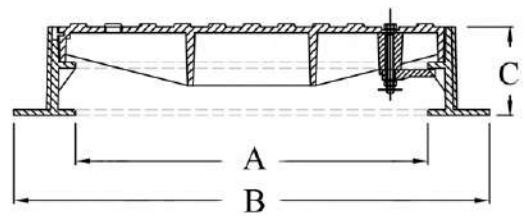
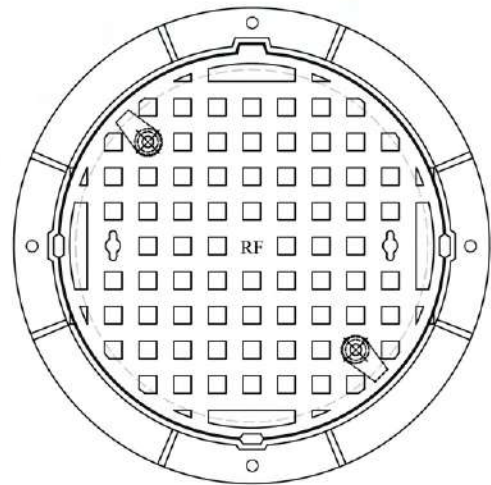

Product Code	Clear Opening A (mm)	Over Base B (mm)	Depth C (mm)	Loading (TONS)	Specifications
MC - 115 DI (HD)	600Ø	810Ø	150	40	BS - EN 124

Medium and Heavy Duty Grey Cast Iron Covers & Frames

Features:-

- Register
- Open Keyholes
- Two Stainless Steel Locking Bolts
- Three Prising Slots

Options:-

- Closed Keyholes
- Two Galvanized Bolts
- Two Prising Slots

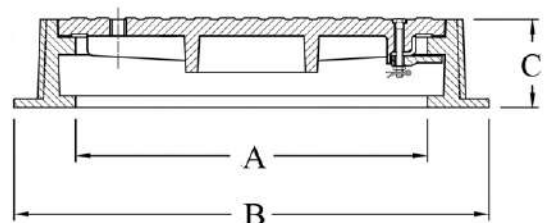
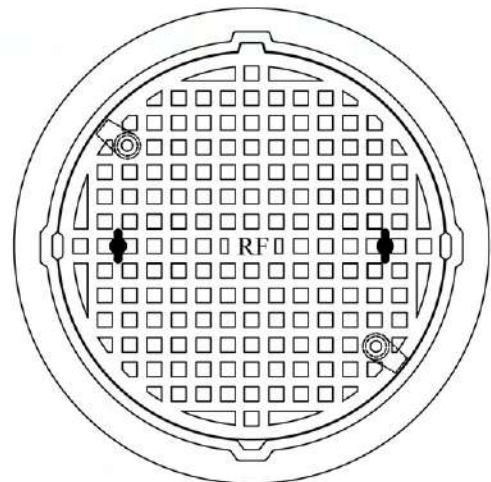

Product Code	Clear Opening A (mm)	Over Base B (mm)	Depth C (mm)	Loading (TONS)	Specifications
MC - 115 (MD)	600Ø	810Ø	150	12.5	BS - EN 124
MC - 115 (HD)	600Ø	810Ø	150	40	BS - EN 124

Heavy Duty Grey Cast Iron Covers & Frames with Safety Grid

Features:-

- Safety Grid
- Closed Key Holes
- Locking Device from Grid to Frame
- Register
- Prising Slots

Options:-

- 2 - 25mm \varnothing Vent Holes

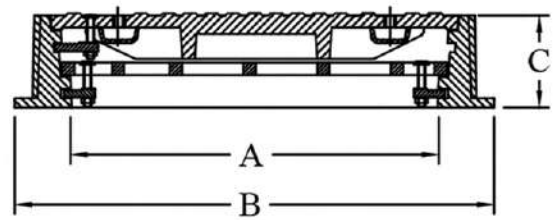
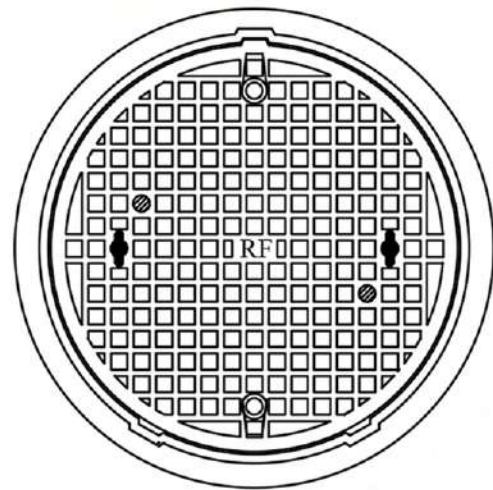

Product Code	Clear Opening A (mm)	Over Base B (mm)	Depth C (mm)	Loading (TONS)	Specifications
MC - 115 R1 SG (HD)	600 \varnothing	780 \varnothing	150	40	BS - EN 124
MC - 115 R2 SG (HD)	600 \varnothing	780 \varnothing	200	40	BS - EN 124

Heavy Duty Grey Cast Iron Covers & Frames

Features:-

- Register
- Closed Keyholes
- Three Prising Slots
- Two Locking Device

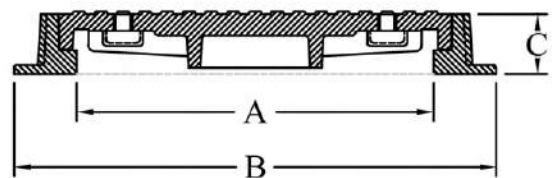
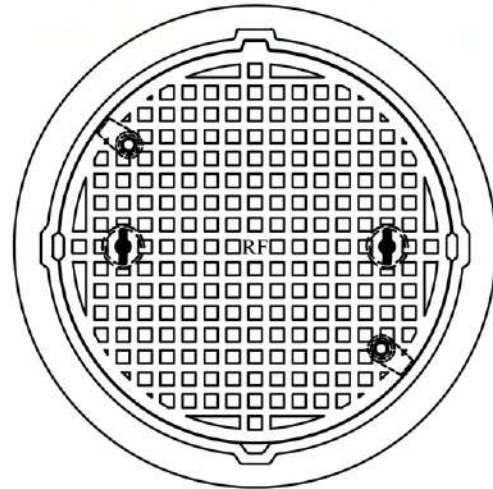

Product Code	Clear Opening A (mm)	Over Base B (mm)	Depth C (mm)	Loading (TONS)	Specifications
MC - 115 A4 (HD)	600 \varnothing	810 \varnothing	100	40	BS - EN 124

Heavy Duty Ductile Cast Iron Covers & Frames

Features:-

- Closed Keyholes
- Two Prising Slots
- Two Locking Device
- Register
- Foundation Holes For Anchoring

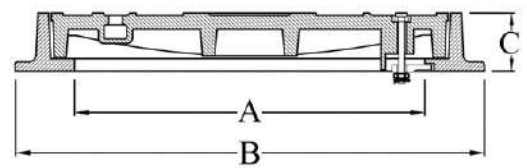
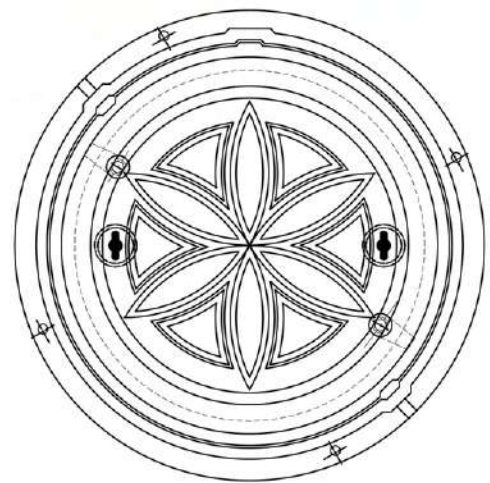

Product Code	Clear Opening A (mm)	Over Base B (mm)	Depth C (mm)	Loading (TONS)	Specifications
MC - 116 R2 DI (HD)	600 Ø	850 Ø	100	40	BS - EN 124

Heavy Duty Grey Cast Iron Covers & Frames

Features:-

- Closed Keyholes
- Three Prising Slots
- Two Locking Device
- Register

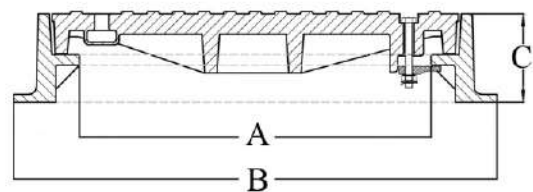
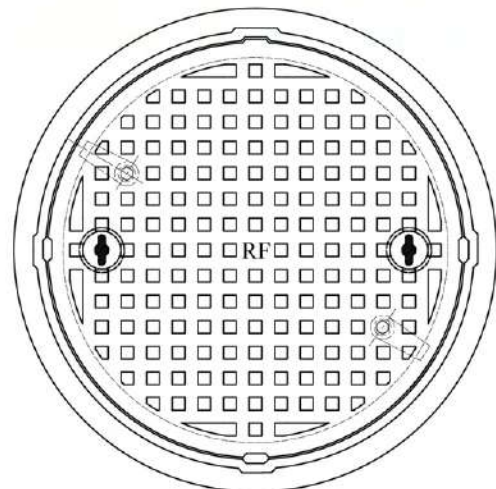

Product Code	Clear Opening A (mm)	Over Base B (mm)	Depth C (mm)	Loading (TONS)	Specifications
MC - 116 (HD)	610 Ø	800 Ø	100	40	BS - EN 124

Heavy Duty Grey Cast Iron Covers & Frames

Features:-

- Closed Key Holes

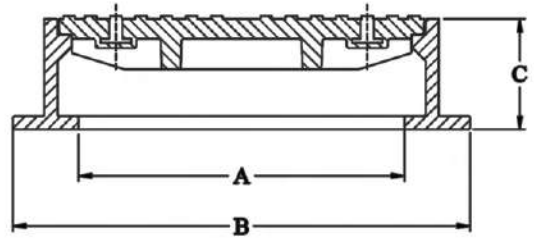
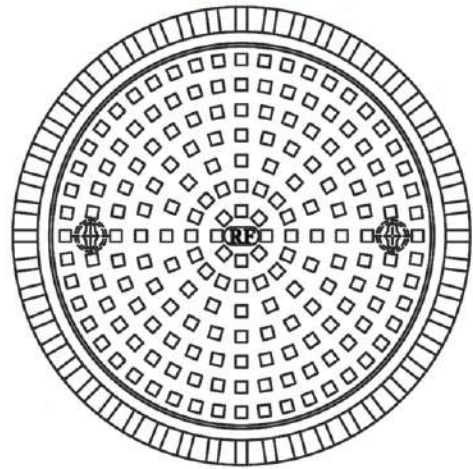

Product Code	Clear Opening A (mm)	Over Base B (mm)	Depth C (mm)	Loading (TONS)	Specifications
MC - 125 (HD)	622Ø	850Ø	208	35	BS - EN

Heavy Duty Grey Cast Iron Cover & Frames

Features:-

- Register
- Closed Keyholes
- Two Prising Slots

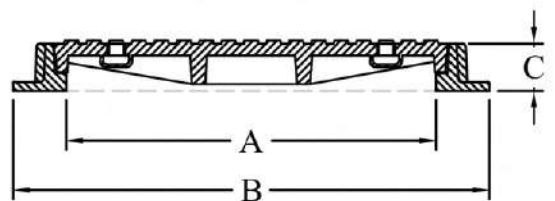
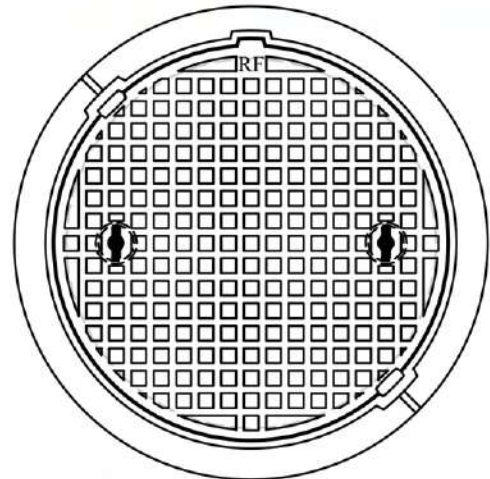

Product Code	Clear Opening A (mm)	Over Base B (mm)	Depth C (mm)	Loading (TONS)	Specifications
MC - 112 R (HD)	625Ø	800Ø	80	40	BS - EN 124

Heavy Duty Grey Cast Iron Covers & Frames

Features:-

- Two Prising Slots
- Four Holes for Anchoring
- Four Air Vent Holes

MC - 120 A (HD) used
ROYAL COMMISSION PROJECT

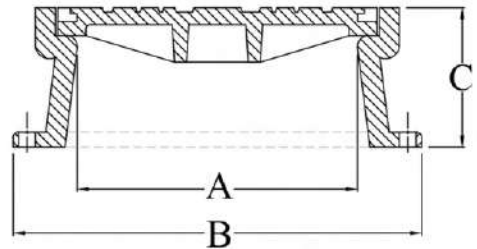
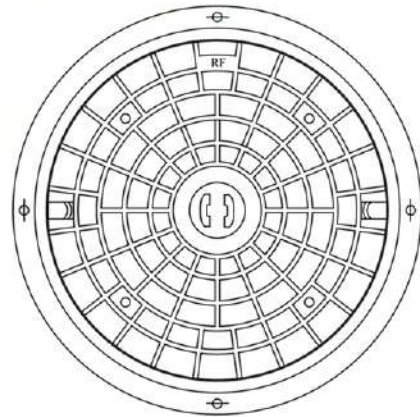

Product Code	Clear Opening A (mm)	Over Base B (mm)	Depth C (mm)	Loading (TONS)	Specifications
MC - 120 A (HD)	680Ø	880Ø	250	40	BS - EN 124
MC - 120 (HD)	680Ø	880Ø	150	40	BS - EN 124
MC - 120 C (HD)	680Ø	880Ø	100	40	BS - EN 124

Heavy Duty Grey Cast Iron Covers & Frames

Features:-

- Two Prising Slots
- Four Hole For Anchoring
- Four Vent Holes
- Two Locking Device

Options:-

- Without Vent Holes

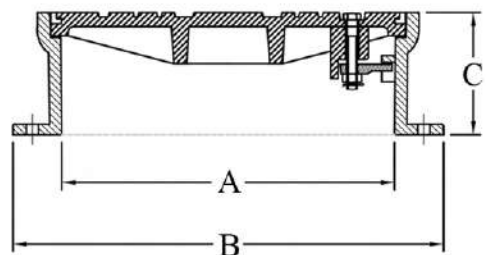
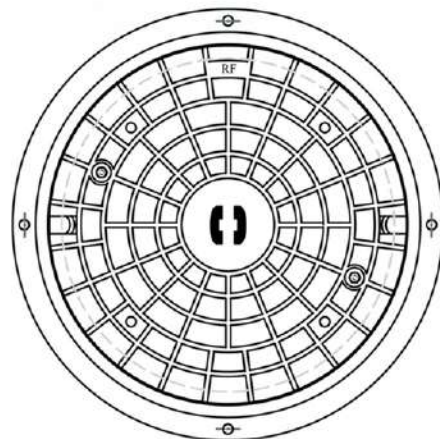

Product Code	Clear Opening A (mm)	Over Base B (mm)	Depth C (mm)	Loading (TONS)	Specifications
MC - 120 AL (HD)	680 Ø	880 Ø	250	40	BS - EN 124

Heavy Duty Grey Cast Iron Covers & Frames

Features:-

- Two Prising Slots
- Four Holes for Anchoring
- Four Air Vent Holes

MC - 120 A 4 (HD) used
ROYAL COMMISSION PROJECT

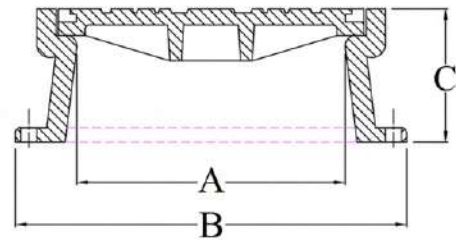
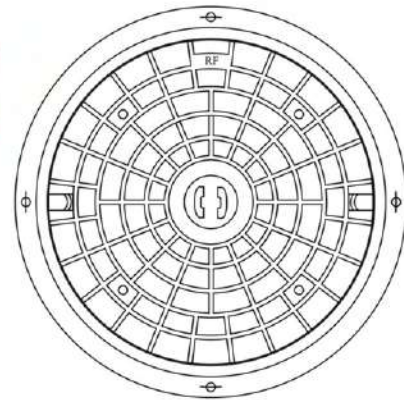

Product Code	Clear Opening A (mm)	Over Base B (mm)	Depth C (mm)	Loading (TONS)	Specifications
MC - 120 A4 (HD)	690Ø	918Ø	250	40	BS - EN 124

Medium and Heavy Duty Ductile Cast Iron cover and Frames

Features:-

- Register
- Closed Keyholes
- Cover Secured to frame
- Provided with Rubber Gasket

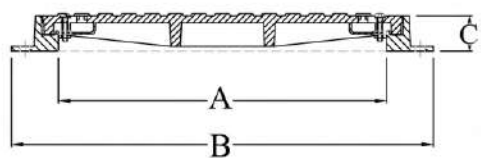
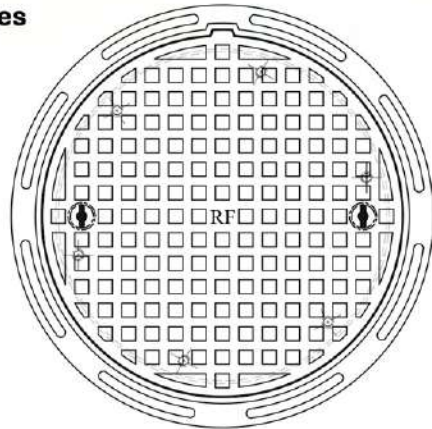

Product Code	Clear Opening A (mm)	Over Base B (mm)	Depth C (mm)	Loading (TONS)	Specifications
MC - 051 A R1 DI (MD)	700 Ø	850 Ø	75	12.5	BS - EN 124
MC - 051 A R1 DI (HD)	700 Ø	850 Ø	75	40	BS - EN 124
MC - 051 AE R1 DI (HD)	700 Ø	850 Ø	75	60	BS - EN 124

Light, Medium and Heavy Duty Grey Cast Iron Covers & Frames

Features:-

- Register
- Closed Keyholes
- Two Prising Slots
- Locking Device

Options:-

- 20mm \varnothing Vent Holes
- Open Key Holes

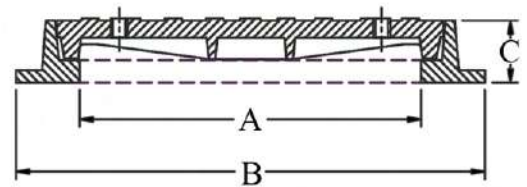
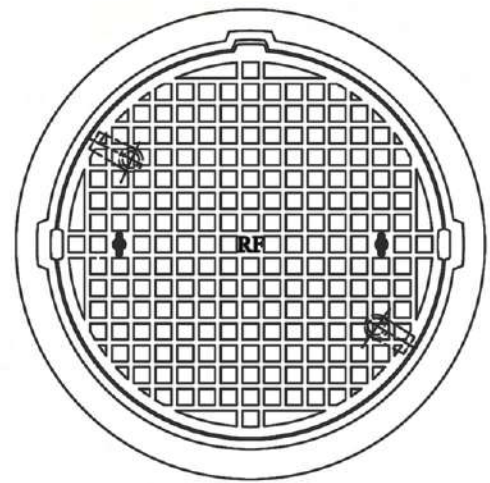

Product Code	Clear Opening A (mm)	Over Base B (mm)	Depth C (mm)	Loading (TONS)	Specifications
MC - 112 (LD)	750 \varnothing	900 \varnothing	80	1.5	BS - EN 124
MC - 112 (MD)	750 \varnothing	900 \varnothing	80	12.5	BS - EN 124
MC - 112 (HD)	750 \varnothing	900 \varnothing	80	40	BS - EN 124

Heavy Duty Grey Cast Iron Covers & Frames

Features:-

- Two Prising Slots
- Four Holes for Anchoring
- Four Air Vent Holes

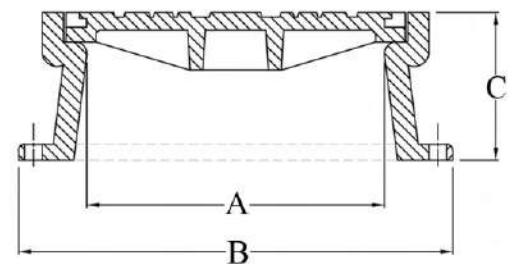
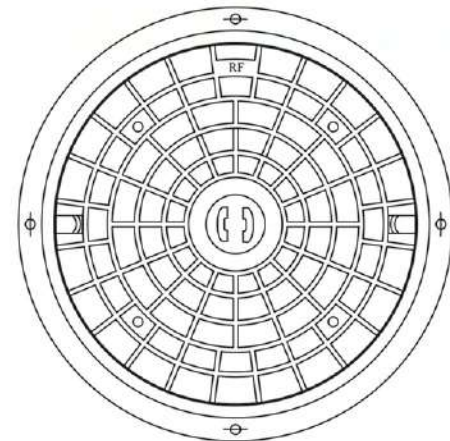

Product Code	Clear Opening A (mm)	Over Base B (mm)	Depth C (mm)	Loading (TONS)	Specifications
MC - 120 AR6 (HD)	750 \varnothing	950 \varnothing	180	40	BS - EN 124

Heavy Duty Grey Cast Iron Covers & Frames

Features:-

- Register
- Closed Keyholes

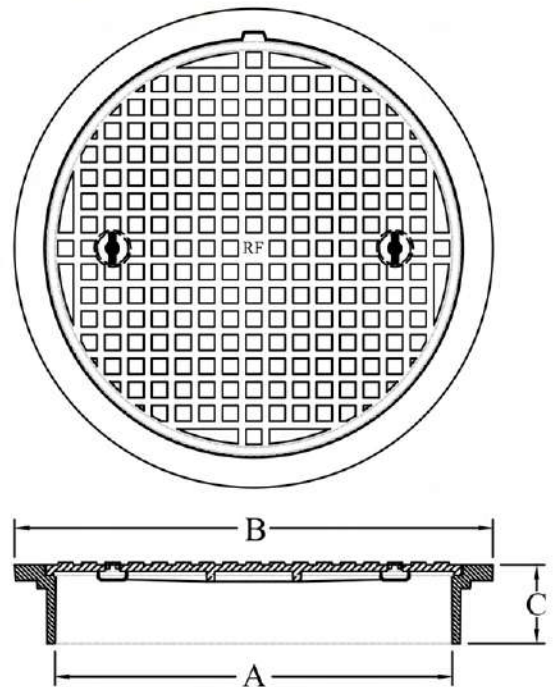

Product Code	Clear Opening A (mm)	Over Base B (mm)	Depth C (mm)	Loading (TONS)	Specifications
MC - 113 R4 (LD)	760 Ø	915 Ø	150	1.5	BS - EN 124
MC - 113 R4 (MD)	760 Ø	915 Ø	150	12.5	BS - EN 124
MC - 113 R4 (HD)	760 Ø	915 Ø	150	40	BS - EN 124

Medium and Heavy Duty Grey Cast Iron Covers & Frames

Features:-

- Register
- Single Seal
- Three Prising Slots
- Closed Key Holes

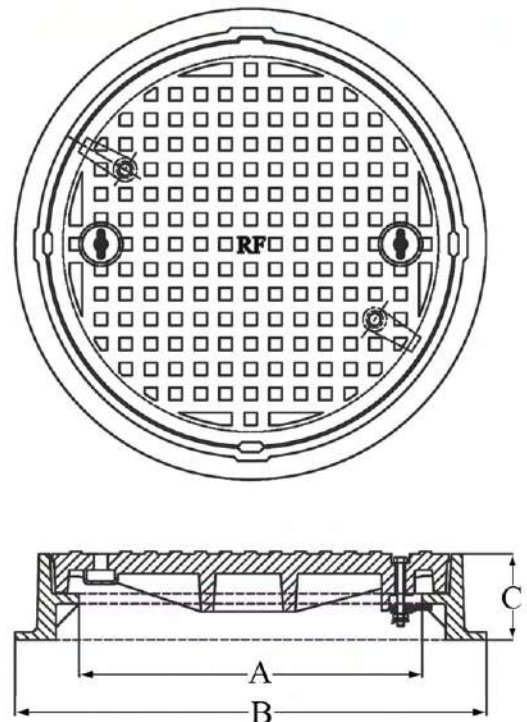

Product Code	Clear Opening A (mm)	Over Base B (mm)	Depth C (mm)	Loading (TONS)	Specifications
MC - 121 (MD)	760 Ø	920 Ø	100	12.5	BS - EN 124
MC - 121 (HD)	760 Ø	920 Ø	100	40	BS - EN 124

Heavy Duty Ductile Cast Iron Covers & Frames

Features:-

- Register
- Closed Keyholes
- Prising Slots
- Double Seal

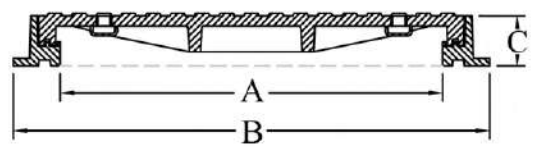
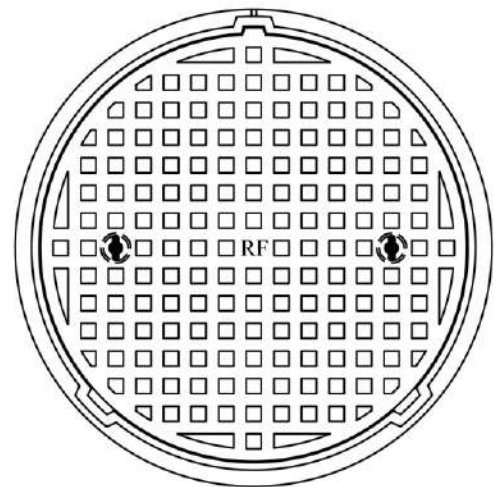

Product Code	Clear Opening A (mm)	Over Base B (mm)	Depth C (mm)	Loading (TONS)	Specifications
MC - 107 DS DI (HD)	800 Ø	1000 Ø	100	40	B S - EN 124

Multi Duty Grey Cast Iron Cover & Frames

Features:-

- Register
- Closed Keyholes
- Two Prising Slots
- Locking Device
- Foundation Holes For Anchoring

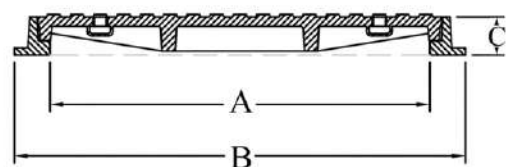
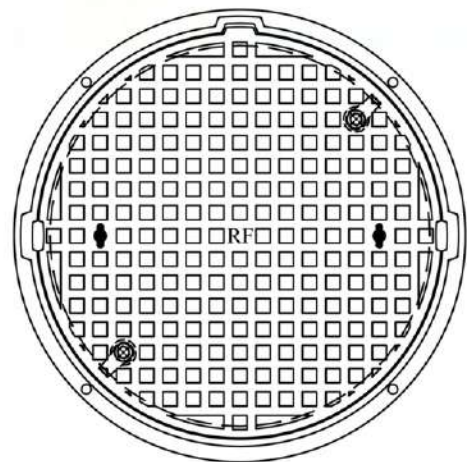

Product Code	Clear Opening A (mm)	Over Base B (mm)	Depth C (mm)	Loading (TONS)	Specifications
MC - 123 (LD)	800 Ø	950 Ø	80	1.5	B S - EN 124
MC - 123 (MD)	800 Ø	950 Ø	80	12.5	B S - EN 124
MC - 123 (HD)	800 Ø	950 Ø	80	40	B S - EN 124

Extra Heavy Duty Ductile Cast Iron Covers & Frames

Features:-

- Closed Keyholes
- Cover Secured to Frame
- Foundation Bolt Slots
- Two Register

Options:-

- Rubber Gasket

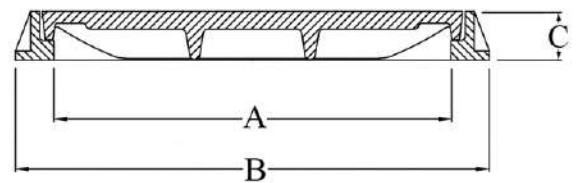
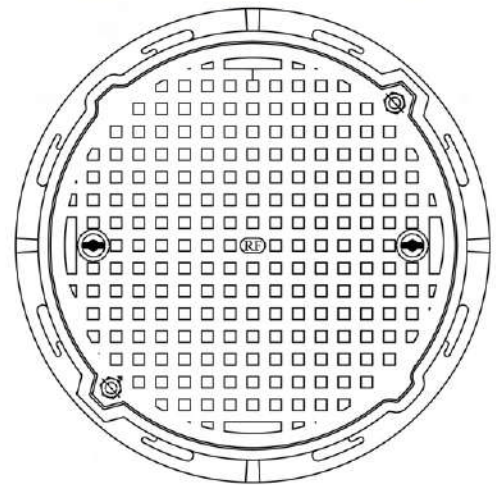

Product Code	Clear Opening A (mm)	Over Base B (mm)	Depth C (mm)	Loading (TONS)	Specifications
MC - 126 DI E (HD)	900Ø	1100Ø	100	60	BS - EN - 124
MC - 126 R DI F (HD)	900Ø	1100Ø	100	90	BS - EN - 124

Medium and Heavy Duty Ductile Cast Iron Covers & Frames

Features:-

- Register
- Cover secured to the Frame
- Closed Keyholes
- Single Seal
- Air Tight
- Rubber Gasket

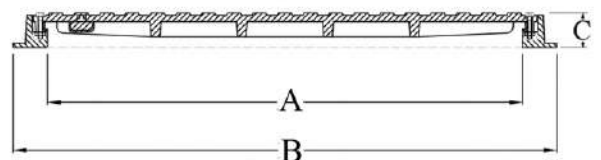
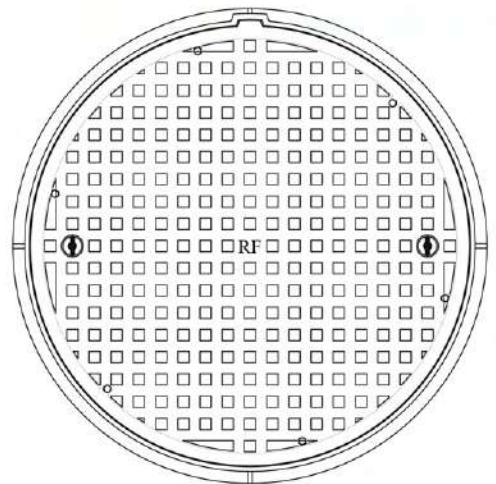

Product Code	Clear Opening A (mm)	Over Base B (mm)	Depth C (mm)	Loading (TONS)	Specifications
MC - 127 D1 R2 (MD)	1100Ø	1200Ø	80	12.5	BS - EN - 124
MC - 127 D1 R2 (HD)	1100Ø	1200Ø	80	40	BS - EN - 124

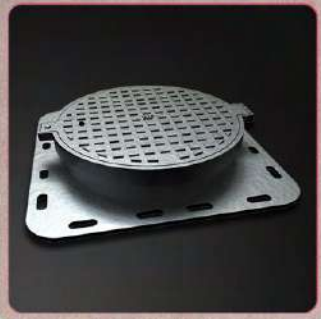

**CIRCULAR COVERS AND
SQUARE FRAMES**

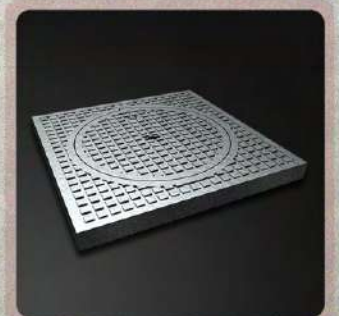

Light Medium and Heavy Duty Ductile Cast Iron Covers & Frames

Features:-

- Lifting Keyholes
- Register

Note : MC 171 LD is Grey Cast Iron

Options:-

- Single Seal
- Air Tight

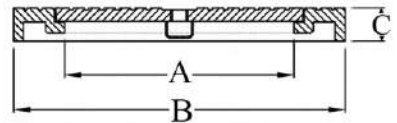
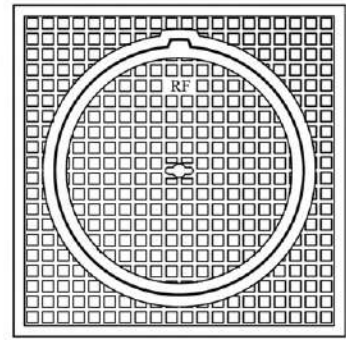

Product Code	Clear Opening A (mm)	Over Base B (mm)	Depth C (mm)	Loading (TONS)	Specifications
MC - 171 R5 DI (HD)	400Ø	600Sq	60	40	BS - EN - 124
MC - 171 DI (MD)	415Ø	600Sq	75	12.5	BS - EN - 124
MC - 171 DI (HD)	415Ø	600Sq	75	40	BS - EN - 124
MC - 171 (LD)	415Ø	600Sq	60	1.5	BS - EN - 124

Medium and Heavy Duty Grey Cast Iron Covers & Frames

Features:-

- Register
- Single Seal
- Two Prising Slots
- Two Closed Keyholes

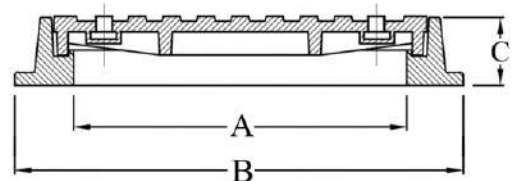
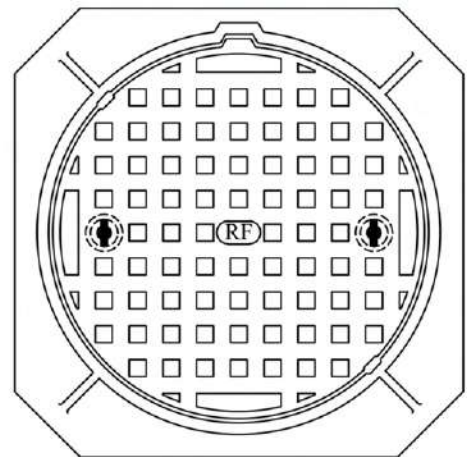

Product Code	Clear Opening A (mm)	Over Base B (mm)	Depth C (mm)	Loading (TONS)	Specifications
MC - 150 (MD)	500Ø	650Sq	100	12.5	BS - EN - 124
MC - 150 (HD)	500Ø	650Sq	100	40	BS - EN - 124

Light Medium and Heavy Duty Ductile Cast Iron Covers & Frames

Features:-

- Lifting Keyholes
- Register

Note : MC 172 LD is Grey Cast Iron

Options:-

- Single Seal
- Air Tight

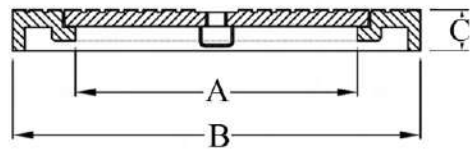
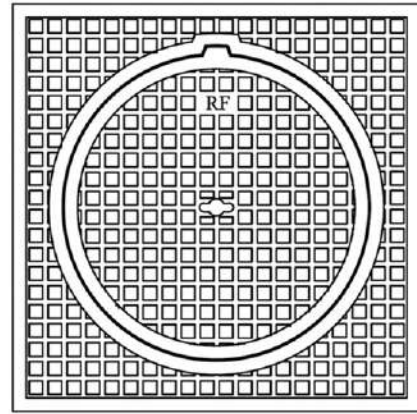

Product Code	Clear Opening A (mm)	Over Base B (mm)	Depth C (mm)	Loading (TONS)	Specifications
MC - 172 (LD)	550Ø	700Sq	45	1.5	BS - EN - 124
MC - 172 DI (MD)	550Ø	700Sq	75	12.5	BS - EN - 124
MC - 172 DI (HD)	550Ø	700Sq	75	40	BS - EN - 124

Medium and Heavy Duty Grey Cast Iron Covers & Frames

Features:-

- Register
- Single Seal
- Two Prising Slots
- Two Closed Keyholes

Features:-

- Open Keyholes
- MC 151 Available with Plain Seated Frame

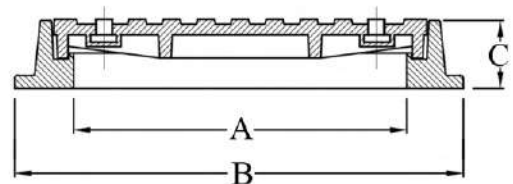
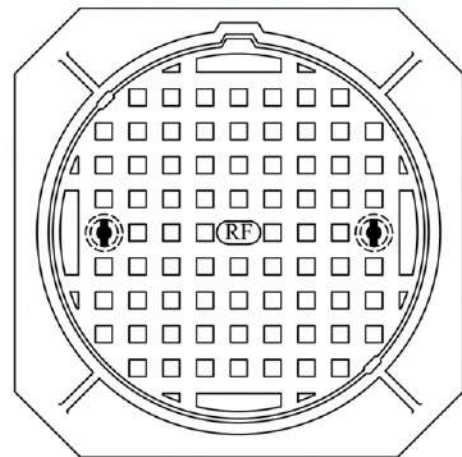

Product Code	Clear Opening A (mm)	Over Base B (mm)	Depth C (mm)	Loading (TONS)	Specifications
MC - 151 (MD)	600Ø	780Sq	100	12.5	BS - EN - 124
MC - 151 (HD)	600Ø	780Sq	100	40	BS - EN - 124

Heavy Duty Ductile Cast Iron Covers & Frames

Features:-

- Register
- Two Prising Slots
- Closed Keyholes
- Two Locking Device

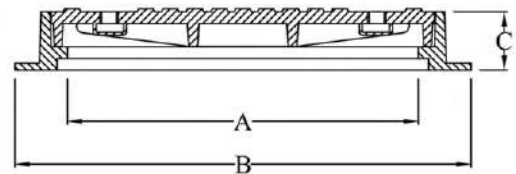
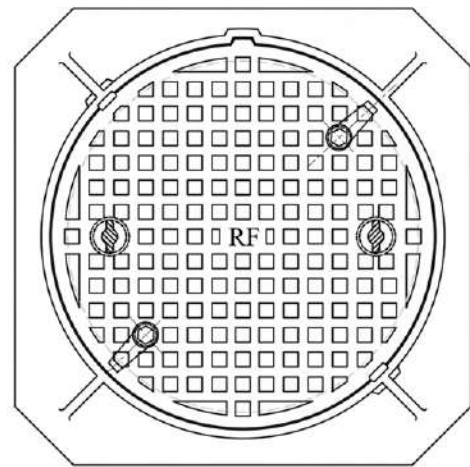

Product Code	Clear Opening A (mm)	Over Base B (mm)	Depth C (mm)	Loading (TONS)	Specifications
MC - 151 RDI (HD)	600Ø	780Sq	100	40	BS - EN - 124

Heavy Duty Grey Cast Iron Covers & Frames

Features:-

- Register
- Closed Keyholes
- Cover Secured to Frame
- Rubber Gasket

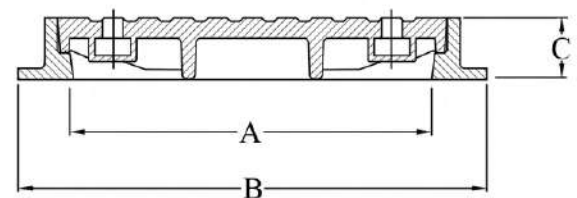
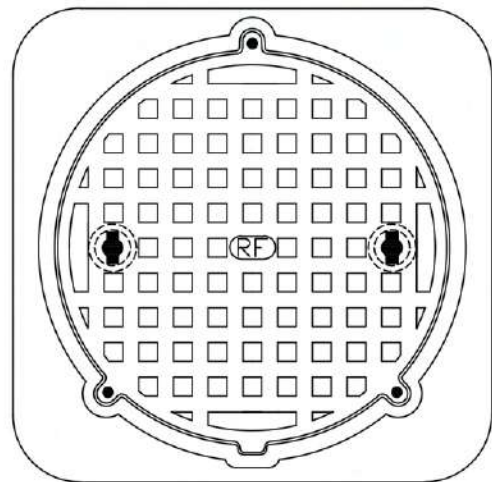

Product Code	Clear Opening A (mm)	Over Base B (mm)	Depth C (mm)	Loading (TONS)	Specifications
MC - 160 (HD)	600Ø	800Sq	100	40	BS - EN

Heavy Duty Ductile Cast Iron Covers & Frames

Features:-

- Closed Keyholes
- Covers Secured to Frame
- Foundation Holes For Anchoring
- Register

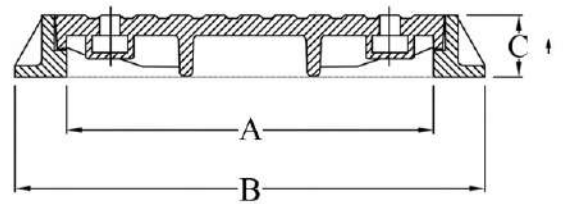
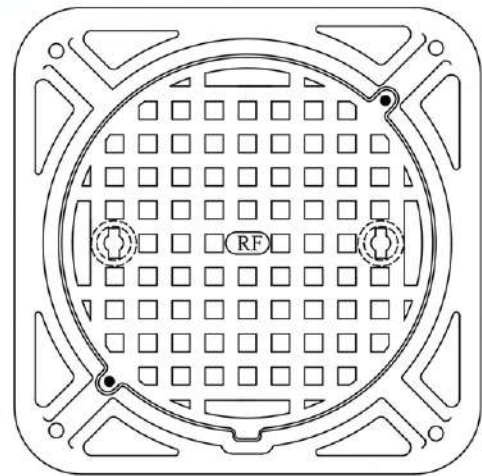

Product Code	Clear Opening A (mm)	Over Base B (mm)	Depth C (mm)	Loading (TONS)	Specifications
MC - 160 R1 D1 (HD)	600Ø	780Sq	100	40	B S - E N - 124

Heavy Duty Grey Cast Iron Covers & Frames

Features:-

- Closed Keyholes
- Two Prising Slots
- Register
- Rubber Gasket

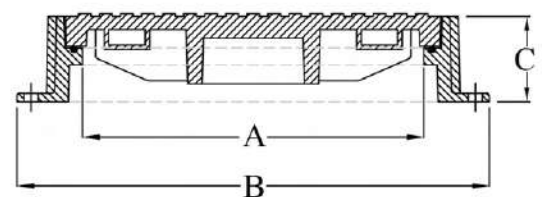
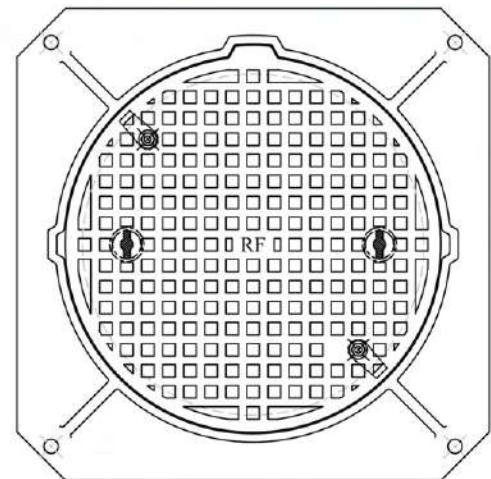

Product Code	Clear Opening A (mm)	Over Base B (mm)	Depth C (mm)	Loading (TONS)	Specifications
MC - 165 (HD)	600Ø	830Sq	150	40	B S - E N - 124

Extra Heavy Duty Ductile Cast Iron Covers and Frames

Features:-

- Closed Keyholes
- Cover Secured to Frame
- Register

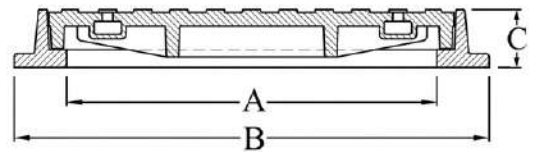
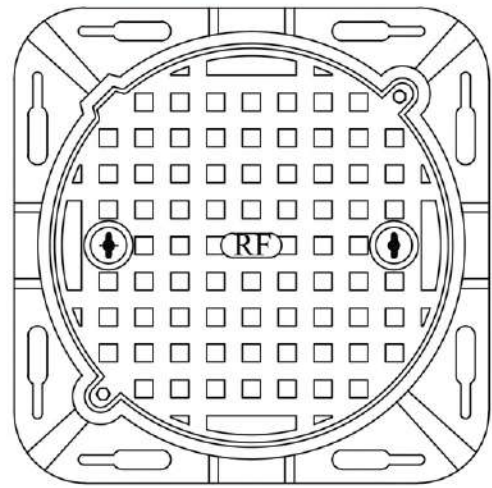

Product Code	Clear Opening A (mm)	Over Base B (mm)	Depth C (mm)	Loading (TONS)	Specifications
MC - 170 DI A1 E (HD)	600Ø	800Sq	100	60	BS - EN - 124
MC - 170 DI A2 F (HD)	600Ø	800Sq	100	90	BS - EN - 124

Heavy Duty Grey Cast Iron Cover & Frames

Features:-

- Double Seal
- Register
- Closed Keyholes
- Airtight

Options:-

- Rubber Gasket

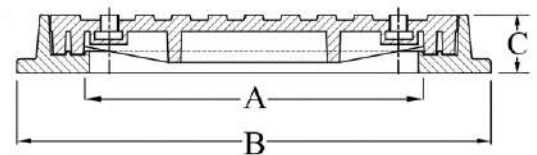
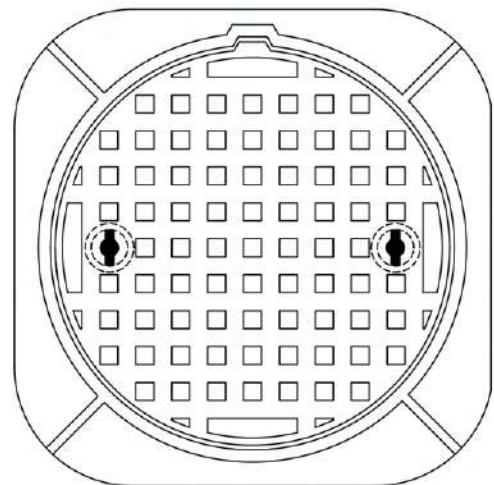

Product Code	Clear Opening A (mm)	Over Base B (mm)	Depth C (mm)	Loading (TONS)	Specifications
MC - 170 ADS (HD)	600Ø	750Sq	100	40	BS - EN - 124

Heavy Duty Ductile Cast Iron Cover & Frames

Features:-

- Cover Hinged to Frame
- Cover Secured to Frame
- Rubber Gasket
- One Closed Keyholes

Options:-

- Rubber Gasket

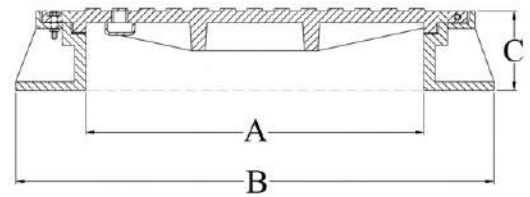
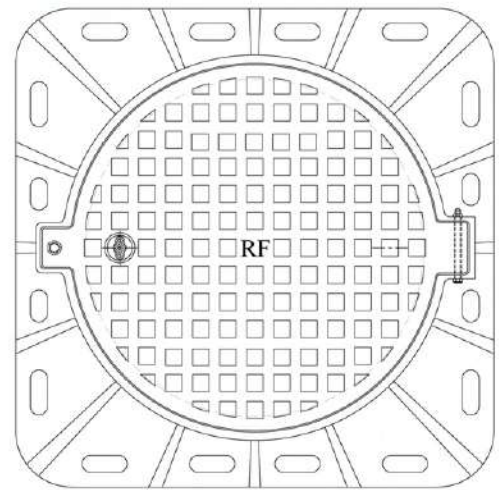

Product Code	Clear Opening A (mm)	Over Base B (mm)	Depth C (mm)	Loading (TONS)	Specifications
MC - 170 R1 DI A2 (HD)	600Sq	850Sq	100	40	BS - EN - 124

Light Duty Grey Cast Iron Covers & Frames

Features:-

- Lifting Keyholes
- Register

Options:-

- Single Seal
- Air Tight

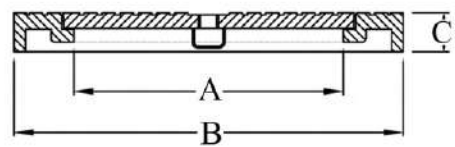
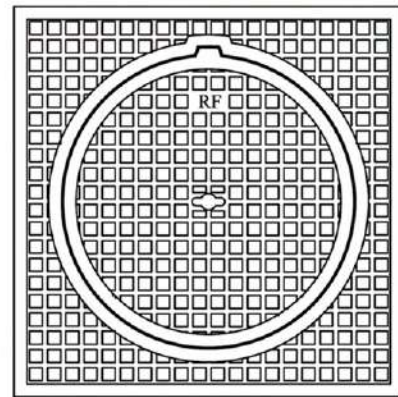

Product Code	Clear Opening A (mm)	Over Base B (mm)	Depth C (mm)	Loading (TONS)	Specifications
MC - 173 (LD)	600Ø	800Sq	45	1.5	BS - EN - 124
MC - 174 (LD)	600Ø	890Sq	50	1.5	BS - EN - 124
MC - 175 (LD)	600Ø	900Sq	45	1.5	BS - EN - 124
MC - 176 (LD)	600Ø	1000Sq	50	1.5	BS - EN - 124
MC - 177 (LD)	600Ø	1100Sq	50	1.5	BS - EN - 124

Medium and Heavy Duty Ductile Cast Iron Covers & Frames

Features:-

- Lifting Keyholes
- Register

Options:-

- Single Seal
- Air Tight

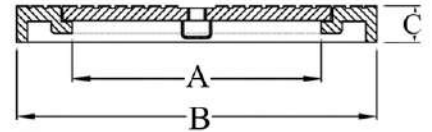
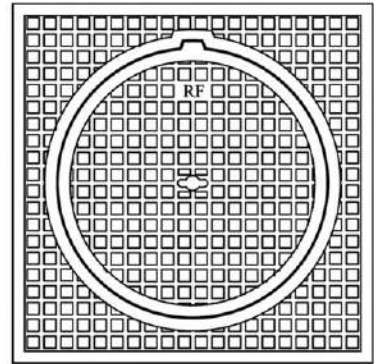

Product Code	Clear Opening A (mm)	Over Base B (mm)	Depth C (mm)	Loading (TONS)	Specifications
MC - 173 DI (HD)	600Ø	800Sq	75	40	B S - E N - 124
MC - 175 DI (MD)	600Ø	800Sq	75	12.5	B S - E N - 124
MC - 175 DI (HD)	600Ø	900Sq	75	40	B S - E N - 124
MC - 176 DI (MD)	600Ø	1000Sq	75	12.5	B S - E N - 124
MC - 176 DI (HD)	600Ø	1000Sq	75	40	B S - E N - 124

Medium and Heavy Duty Grey Cast Iron Covers & Frames

Features:-

- Register
- Single Seal
- Closed Keyholes
- Two Prising Slots
- Foundation Holes For Anchoring

Options:-

- Plain Seated

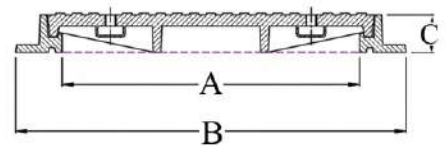
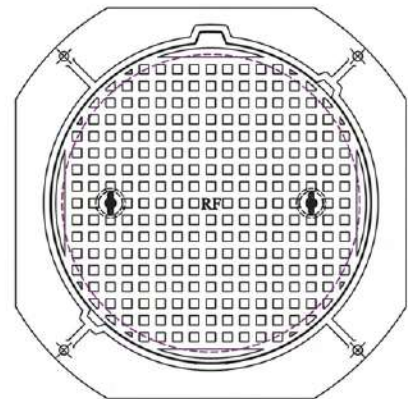

Product Code	Clear Opening A (mm)	Over Base B (mm)	Depth C (mm)	Loading (TONS)	Specifications
MC - 170 R6 (HD)	700Ø	950Sq	100	40	B S - E N - 124



Heavy Duty Grey Cast Iron Covers & Frames

Features:-

- Closed Keyholes
- Two Prising Slots
- Register
- Rubber Gasket

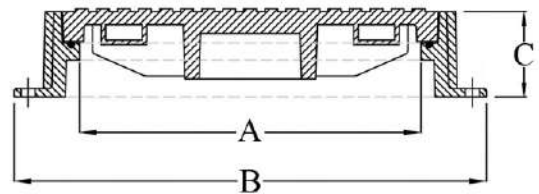
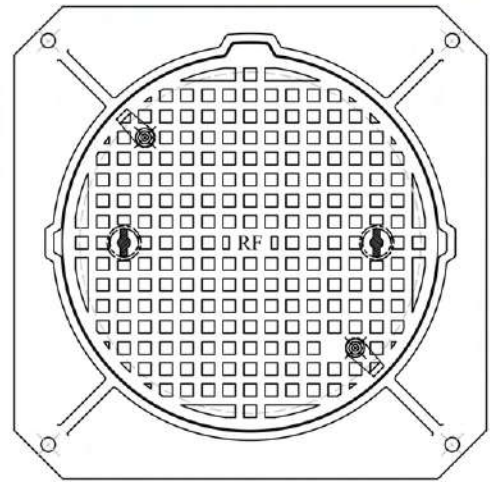

Product Code	Clear Opening A (mm)	Over Base B (mm)	Depth C (mm)	Loading (TONS)	Specifications
MC - 165 R2 (HD)	750Ø	950Sq	100	40	BS - EN - 124

Heavy Duty Ductile Cast Iron Covers & Frames

Features:-

- Register
- Closed Keyholes
- Cover Secured to Frame
- Foundation Holes For Anchoring

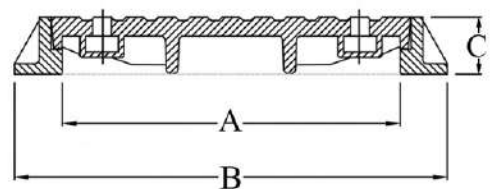
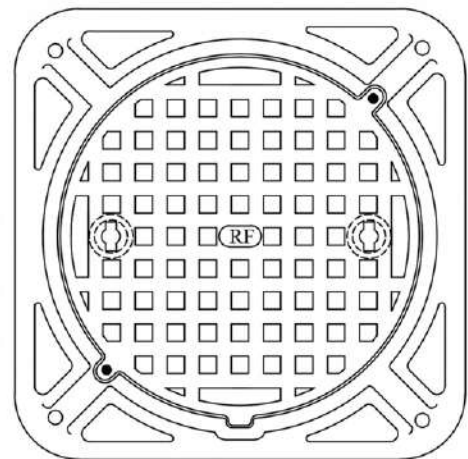

Product Code	Clear Opening A (mm)	Over Base B (mm)	Depth C (mm)	Loading (TONS)	Specifications
MC - 161 DI (HD)	800Ø	1000Sq	100	40	BS - EN - 124

Medium and Heavy Duty Grey Cast Iron Covers & Frames

Features:-

- Register
- Single Seal
- Closed Keyholes
- Two Prising Slots
- Foundation Holes For Anchoring

Options:-

- Plain Seated

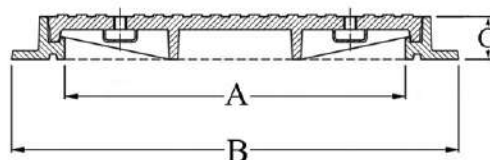
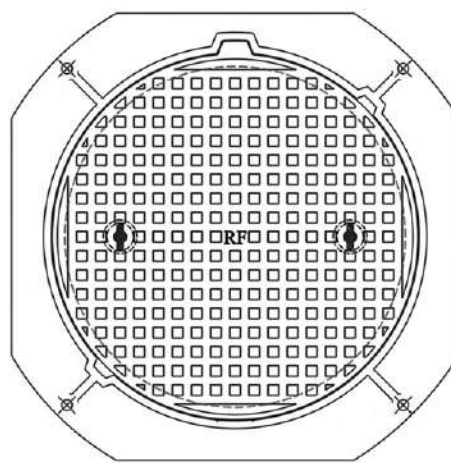

Product Code	Clear Opening A (mm)	Over Base B (mm)	Depth C (mm)	Loading (TONS)	Specifications
MC - 170 (MD)	800Ø	1050Sq	100	12.5	B S - E N - 124
MC - 170 (HD)	800Ø	1050Sq	100	40	B S - E N - 124
MC - 170 AR3 (HD)	800Ø	1060Sq	100	40	B S - E N - 124

Heavy Duty Grey Cast Iron Covers and Frames

Features:-

- Closed Keyholes
- Double Seal
- Two Prising Slots
- Register
- Foundation Holes For Anchoring
- Two Locking Bolts
- Air Tight

Options:-

- Rubber Gasket

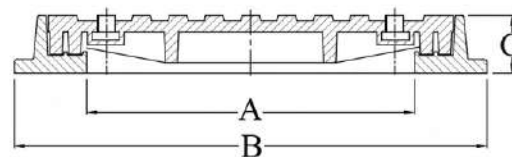
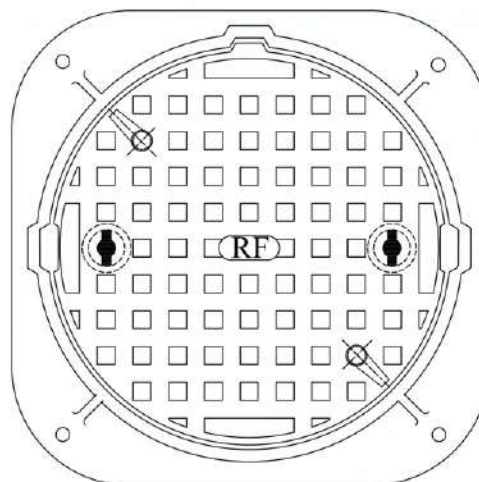

Product Code	Clear Opening A (mm)	Over Base B (mm)	Depth C (mm)	Loading (TONS)	Specifications
MC - 170 AR1 (HD)	900Ø	1160Sq	100	40	B S - E N - 124

Heavy Duty Ductile Cast Iron Covers and Frames

Features:-

- Closed Keyholes
- Two Prising Slots
- Register

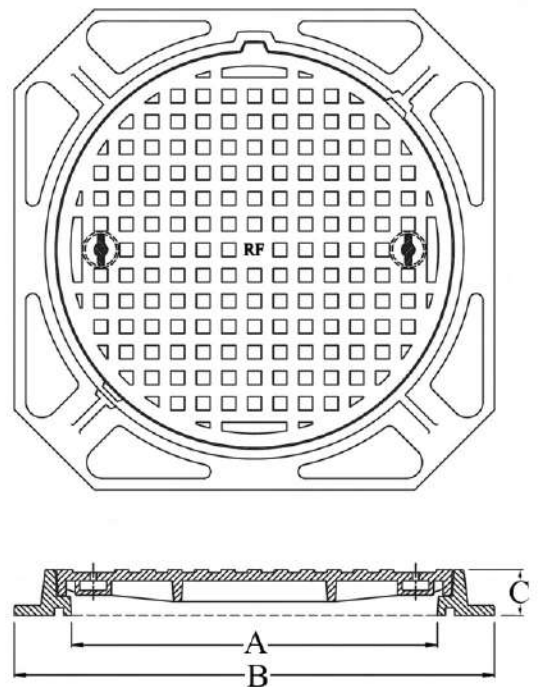

Product Code	Clear Opening A (mm)	Over Base B (mm)	Depth C (mm)	Loading (TONS)	Specifications
MC - 170 DI (HD)	900Ø	1160Sq	100	40	BS - EN - 124

Heavy Duty Grey Cast Iron Covers & Frames

MC - 131 (HD) Used ROYAL COMMISSION PROJECT

Features:-

- 2 Closed Keyholes
- Foundation Holes For Anchoring

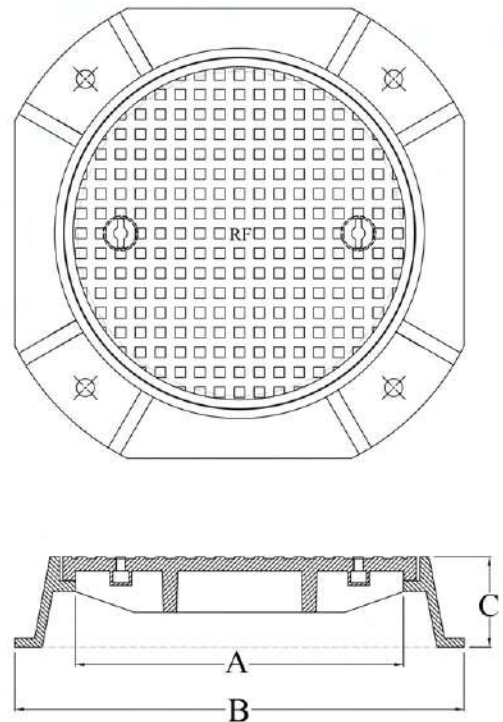

Product Code	Clear Opening A (mm)	Over Base B (mm)	Depth C (mm)	Loading (TONS)	Specifications
MC - 131 (HD)	915Ø	1270Sq	140	40	BS - EN - 124

Heavy Duty Ductile Cast Iron Covers & Frames

Features:-

- Closed Keyholes
- Foundation Holes For Anchoring

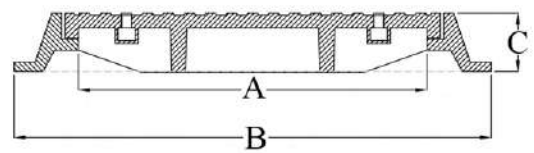
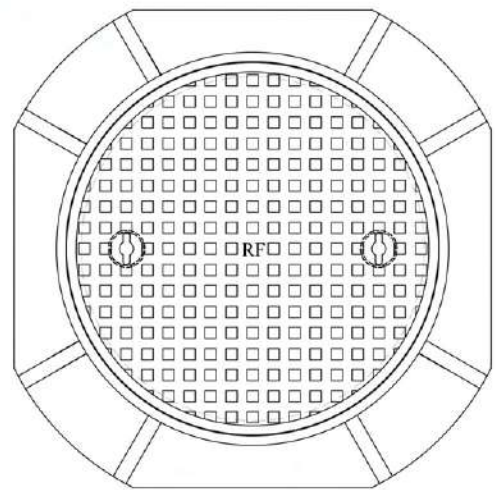

Product Code	Clear Opening A (mm)	Over Base B (mm)	Depth C (mm)	Loading (TONS)	Specifications
MC - 131 RDI (HD)	915Ø	1270Ø	150	40	BS - EN - 124

Heavy Duty Grey Cast Iron Covers & Frames

Features:-

- 2 Closed Keyholes
- Foundation Holes For Anchoring

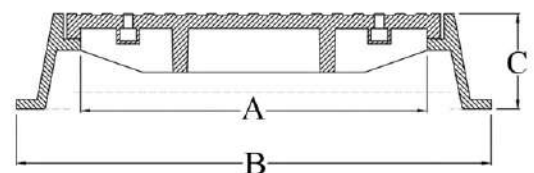
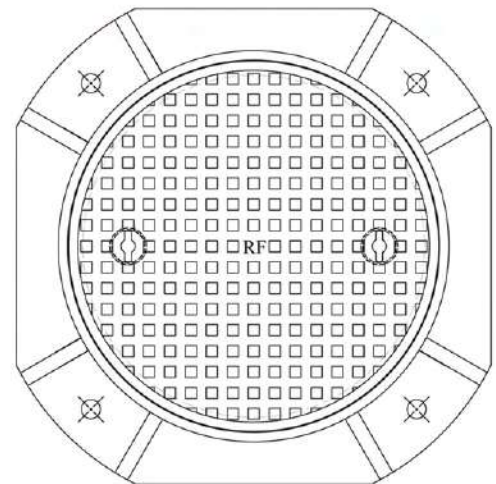

Product Code	Clear Opening A (mm)	Over Base B (mm)	Depth C (mm)	Loading (TONS)	Specifications
MC - 130 (HD)	920Ø	1270 Sq	255	40	BS - EN - 124



Heavy Duty Grey Cast Iron Kerb Covers and Frames

- Features:-**
 - Side Inlet

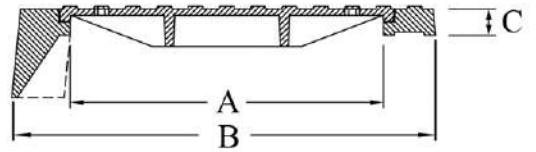
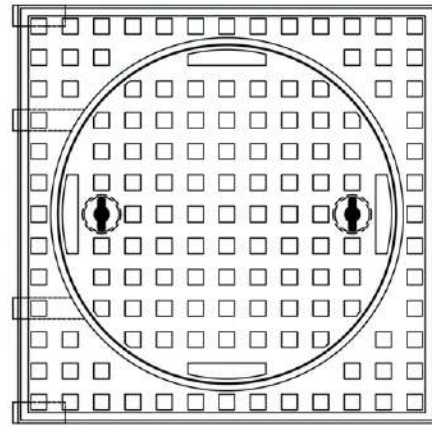

Product Code	Clear Opening A (mm)	Over Base B (mm)	Depth C (mm)	Loading (TONS)	Specifications
RF - CG 481 - 170	600Ø	800Sq	170 / 50	40	BS - EN 124
RF - CG 481 - 250	560Ø	850 X 780	250 / 50	40	BS - EN 124



SQUARE COVERS AND FRAMES

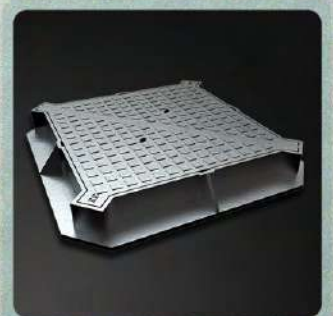

Light, Medium and Heavy Duty Grey Cast Iron Covers & Frames

Features:-

- Closed Keyholes
- Register

Options:-

- Single Seal

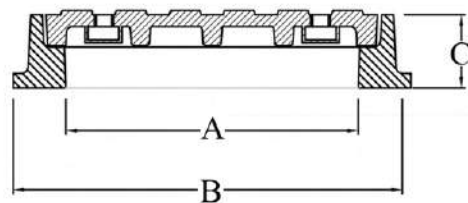
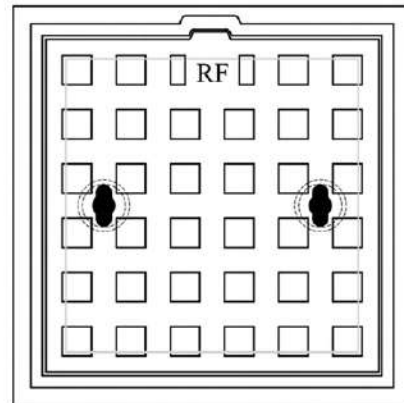

Product Code	Clear Opening A (mm)	Over Base B (mm)	Depth C (mm)	Loading (TONS)	Specifications
MC - 200 (LD)	200Sq	260Sq	50	1.5	B S - E N - 124
MC - 200 (MD)	200Sq	260Sq	50	12.5	B S - E N - 124
MC - 200 (HD)	200Sq	260Sq	50	40	B S - E N - 124
MC - 201 (LD)	300Sq	360Sq	50	1.5	B S - E N - 124
MC - 201 (MD)	300Sq	360Sq	50	12.5	B S - E N - 124
MC - 201 (HD)	300Sq	360Sq	50	40	B S - E N - 124

Heavy Duty Ductile Cast Iron Cover & Frames

Features:-

- Closed Keyholes

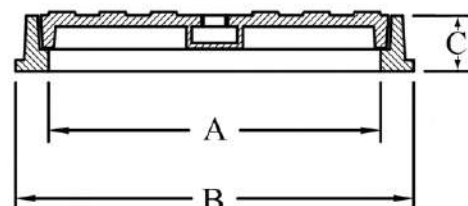
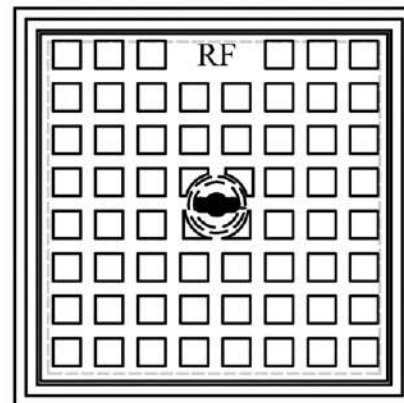

Product Code	Clear Opening A (mm)	Over Base B (mm)	Depth C (mm)	Loading (TONS)	Specifications
MC - 201 DI (HD)	300Sq	360Sq	50	40	B S - E N 124



Light Duty Grey Cast Iron Covers & Frames

Features:-

- Single Seal
- Register
- Lifting Handle
- Airtight

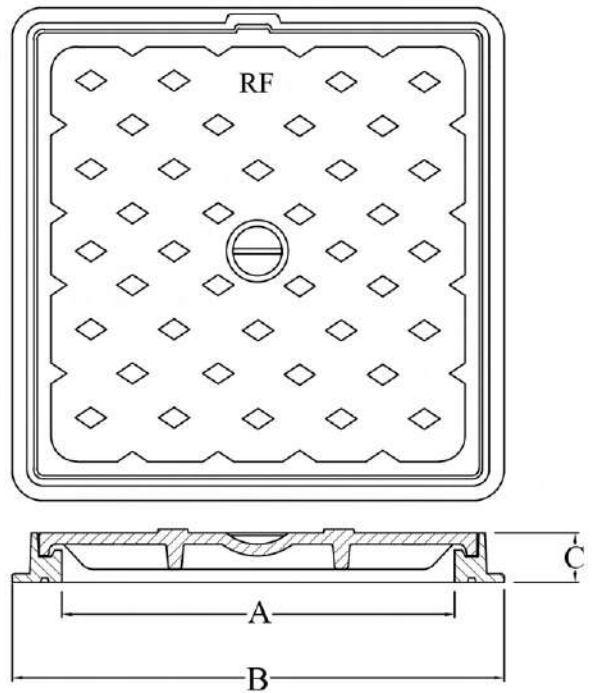

Product Code	Clear Opening A (mm)	Over Base B (mm)	Depth C (mm)	Loading (TONS)	Specifications
MC - 203 (LD)	300Sq	400Sq	30	1.5	B S - EN 124

Medium and Heavy Duty Grey Cast Iron Covers & Frames

Features:-

- Closed Keyholes
- Register

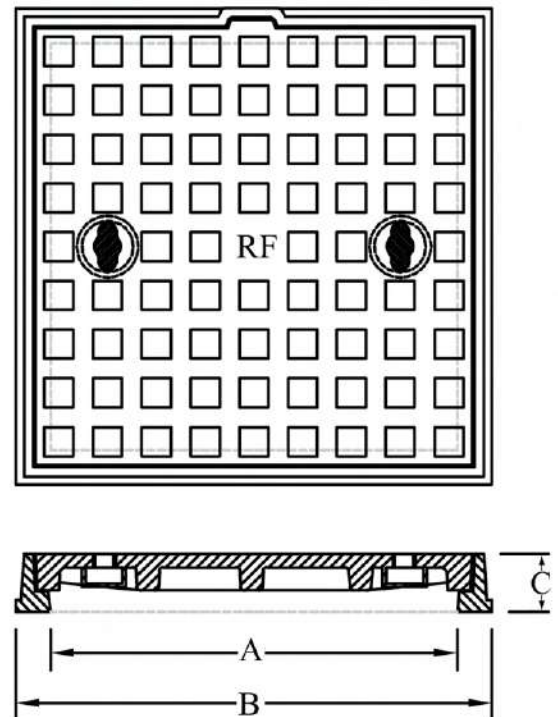

Product Code	Clear Opening A (mm)	Over Base B (mm)	Depth C (mm)	Loading (TONS)	Specifications
MC - 201 R2 (MD)	350Sq	410Sq	50	12.5	B S - EN 124
MC - 201 R2 (HD)	350Sq	410Sq	50	40	B S - EN 124

Light, Medium and Heavy Duty Grey Cast Iron Covers & Frames

Features:-

- Closed Keyholes
- Register

Options:-

- Single Seal

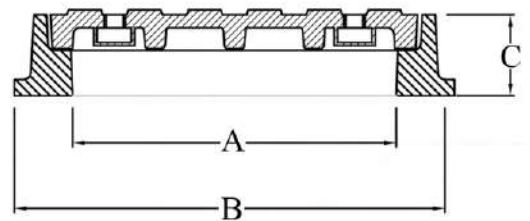
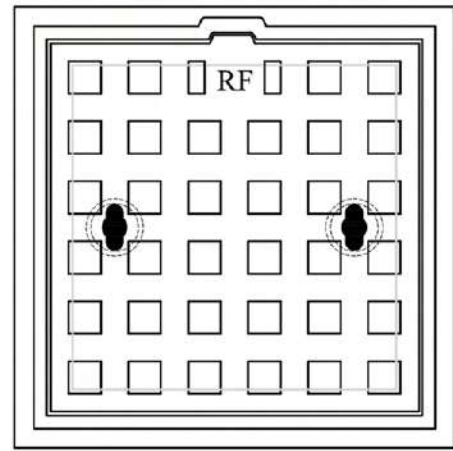

Product Code	Clear Opening A (mm)	Over Base B (mm)	Depth C (mm)	Loading (TONS)	Specifications
MC - 202 (LD)	400Sq	460Sq	50	1.5	B S - E N - 124
MC - 202 (MD)	400Sq	510Sq	50	12.5	B S - E N - 124
MC - 202 (HD)	400Sq	550Sq	75	40	B S - E N - 124

Light Duty Grey Cast Iron Covers & Frames

Features:-

- Single Seal
- Register
- Lifting Handle
- Airtight

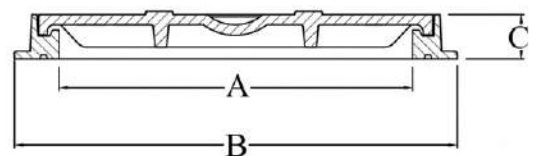
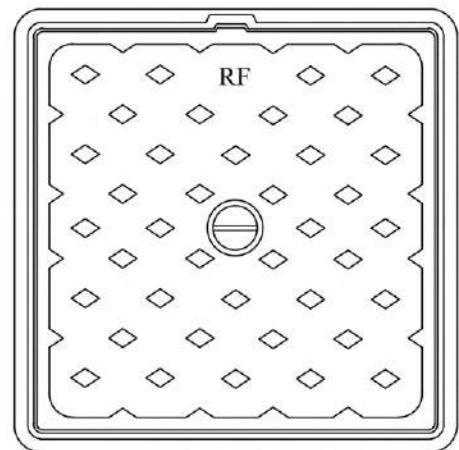

Product Code	Clear Opening A (mm)	Over Base B (mm)	Depth C (mm)	Loading (TONS)	Specifications
MC - 203 R1 (LD)	400Sq	500Sq	30	1.5	B S - E N 124



Heavy Duty Grey Cast Iron Covers and Frames

Features:-

- Closed Keyholes
- Double Triangular
- Three Point Suspension
- Four Prising Slots

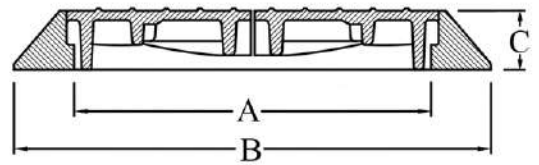
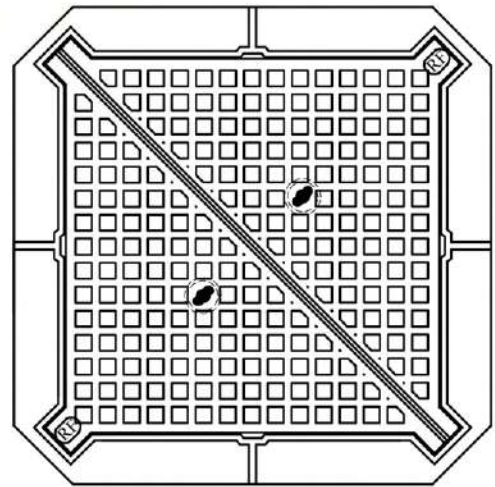

Product Code	Clear Opening A (mm)	Over Base B (mm)	Depth C (mm)	Loading (TONS)	Specifications
MC - 204 R1 DT (HD)	400Sq	550Sq	75	40	B S - EN 124

Medium and Heavy Duty Grey Cast Iron Covers & Frames

Features:-

- Closed Keyholes
- Register

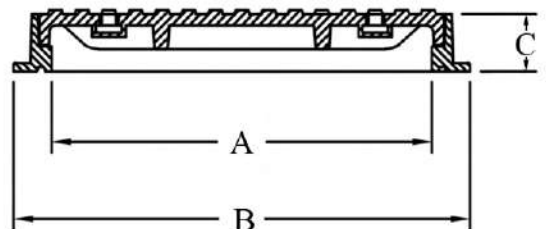
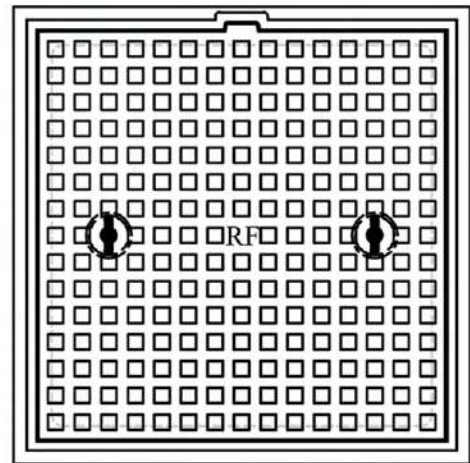

Product Code	Clear Opening A (mm)	Over Base B (mm)	Depth C (mm)	Loading (TONS)	Specifications
MC - 203 AR4 (MD)	450Sq	550Sq	75	12.5	B S - EN 124
MC - 203 AR4 (HD)	450Sq	550Sq	75	40	B S - EN 124

Light Duty Grey Cast Iron Covers & Frames

Features:-

- Single Seal
- Register
- Lifting Handle
- Airtight

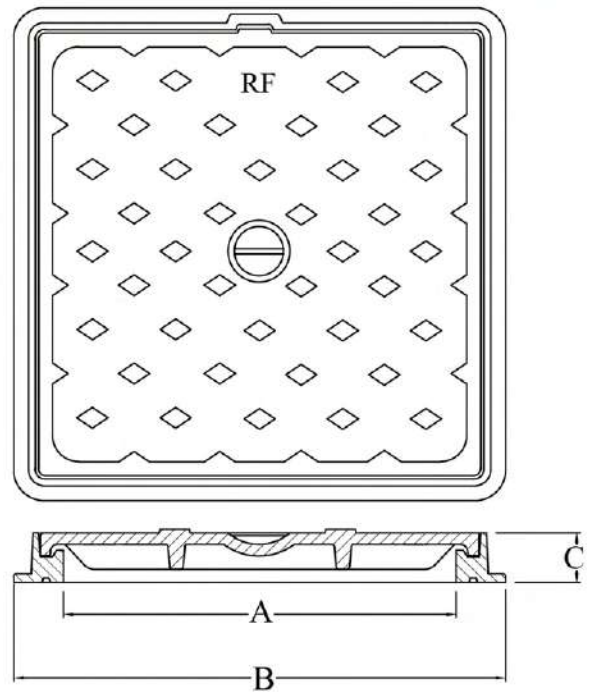

Product Code	Clear Opening A (mm)	Over Base B (mm)	Depth C (mm)	Loading (TONS)	Specifications
MC - 203 R2 (LD) MC - 203 R3 (LD)	450Sq 500Sq	550Sq 600Sq	30 30	1.5 1.5	BS - EN 124 BS - EN 124

Heavy Duty Grey Cast Iron Covers and Frames

Features:-

- Closed Keyholes
- Double Triangular
- Three Point Suspension
- Four Prising Slots

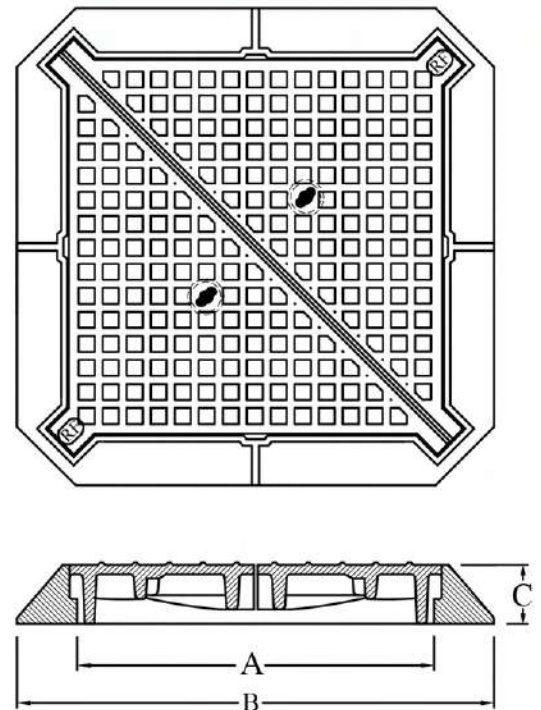

Product Code	Clear Opening A (mm)	Over Base B (mm)	Depth C (mm)	Loading (TONS)	Specifications
MC - 204 R2 DT (HD)	500Sq	650Sq	75	40	BS - EN 124



Light, Medium and Heavy Duty Grey Cast Iron Covers & Frames

Features:-

- Closed Keyholes
- Register
- Single Seal
- MC 205 LD Plane Seated

Note:MC - 205 DI (HD) is Ductile Cast Iron

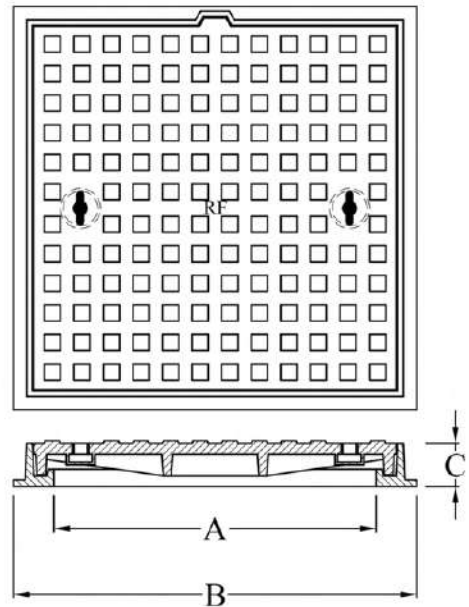

Product Code	Clear Opening A (mm)	Over Base B (mm)	Depth C (mm)	Loading (TONS)	Specifications
MC - 205 (LD)	500Sq	650Sq	80	1.5	B S - EN 124
MC - 205 (MD)	500Sq	650Sq	80	12.5	B S - EN 124
MC - 205 (HD)	500Sq	650Sq	100	40	B S - EN 124
MC - 205 DI (HD)	500Sq	750Sq	100	40	B S - EN 124

Medium and Heavy Duty Grey Cast Iron Covers & Frames

Features:-

- Closed Keyholes
- Cover Secured to Frame
- Single Seal
- Water Tight

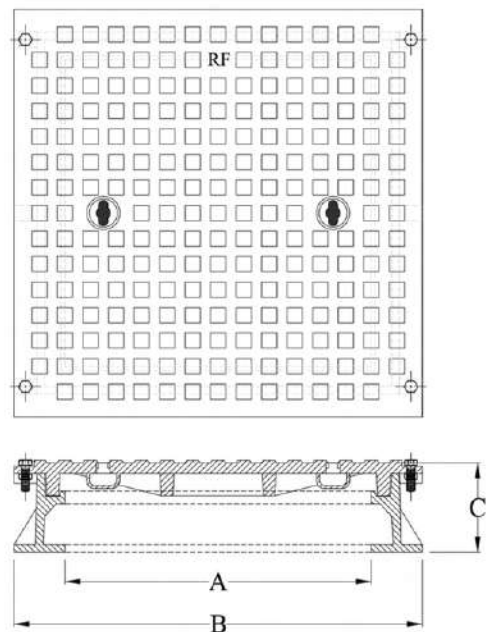

Product Code	Clear Opening A (mm)	Over Base B (mm)	Depth C (mm)	Loading (TONS)	Specifications
MC - 205 RWT (MD)	500Sq	700Sq	150	12.5	B S - EN 124
MC - 205 RWT (HD)	500Sq	700Sq	150	40	B S - EN 124

Heavy Duty Ductile Cast Iron Covers & Frames

Features:-

- Register
- Closed Keyholes

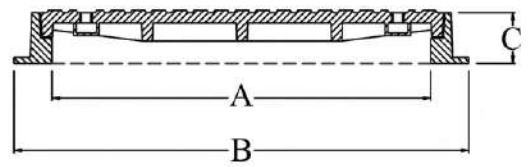
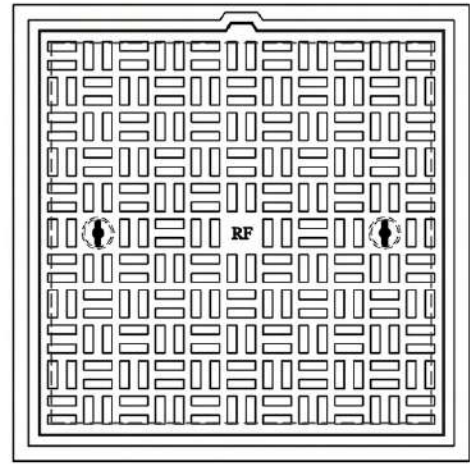

Product Code	Clear Opening A (mm)	Over Base B (mm)	Depth C (mm)	Loading (TONS)	Specifications
MC - 251 DI (HD)	500Sq	750Sq	100	40	B S - E N - 124

Heavy Duty Grey Cast Iron Cover & Frames

Features:-

- Double Triangular
- Three Point Suspension
- Closed Keyholes
- Four Prising Slots

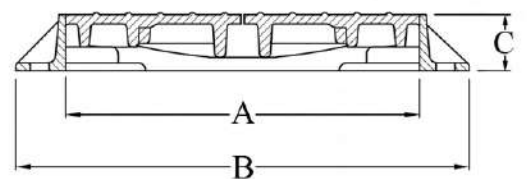
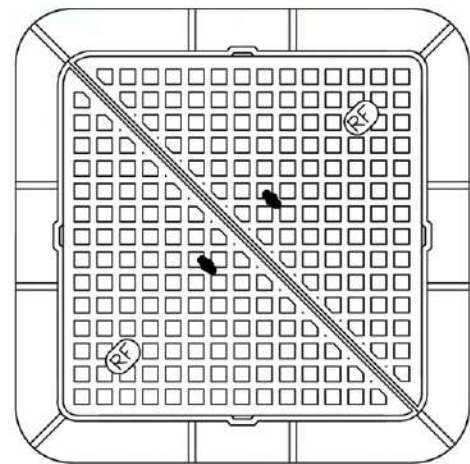

Product Code	Clear Opening A (mm)	Over Base B (mm)	Depth C (mm)	Loading (TONS)	Specifications
MC - 204 R3 DT (HD)	600Sq	800Sq	100	40	B S - E N 124

Heavy Duty Ductile Cast Iron Covers and Frames

Features:-

- Closed Keyholes
- Double Triangular
- Three Point Suspension
- Four Prising Slots

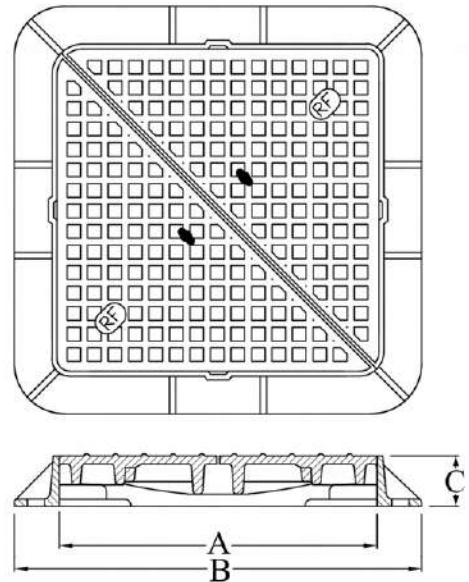

Product Code	Clear Opening A (mm)	Over Base B (mm)	Depth C (mm)	Loading (TONS)	Specifications
MC - 204 R4 DT/DI (HD)	600Sq	800Sq	100	40	B S - E N 124

Light, Medium and Heavy Duty Grey Cast Iron Covers & Frames

Features:-

- Closed Keyholes
- Register
- Single Seal

MC - 210 R2 (HD) Used ROYAL COMMISSION PROJECT

Note: 210 A LD available with Dimond Checkers (as 240 LD)

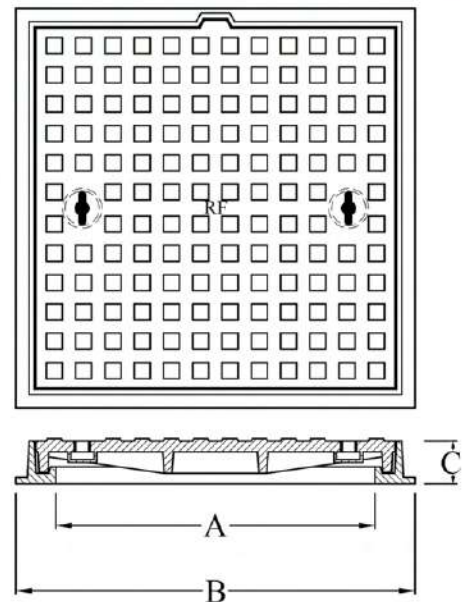

Product Code	Clear Opening A (mm)	Over Base B (mm)	Depth C (mm)	Loading (TONS)	Specifications
MC - 210 (LD)	600Sq	750Sq	80	1.5	B S - E N 124
MC - 210 (MD)	600Sq	750Sq	80	12.5	B S - E N 124
MC - 210 (HD)	600Sq	750Sq	80	40	B S - E N 124
MC - 210 A (LD)	600Sq	700Sq	50	1.5	B S - E N 124
MC - 210 R2 (HD)	600Sq	760Sq	80	40	B S - E N 124
MC - 211 (HD)	600Sq	750Sq	150	40	B S - E N 124
MC - 211 A (HD)	600Sq	800Sq	100	40	B S - E N 124

Medium and Heavy Duty Grey Cast Iron Covers & Frames

Features:-

- Closed Keyholes
- Cover Secured to Frame
- Single Seal
- Water Tight

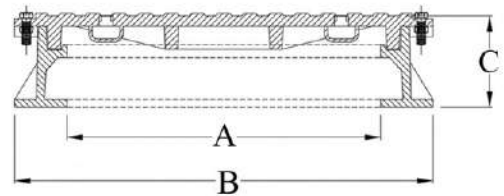
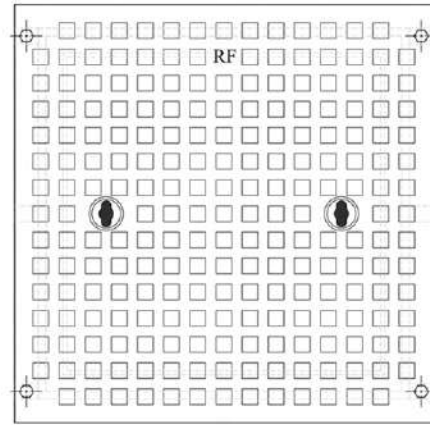

Product Code	Clear Opening A (mm)	Over Base B (mm)	Depth C (mm)	Loading (TONS)	Specifications
MC - 210 RWT (MD)	600Sq	800Sq	175	12.5	B S - EN 124
MC - 210 RWT (HD)	600Sq	800Sq	175	40	B S - EN 124

Medium and Heavy Duty Ductile Cast Iron Covers & Frames

Features:-

- Closed Keyholes
- Register
- Single Seal
- Rubber Gasket
- Cover Secured to Frame

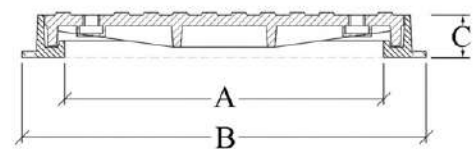
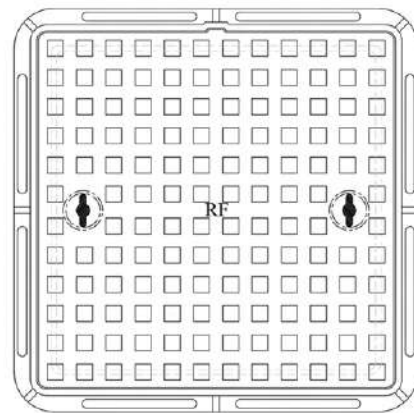

Product Code	Clear Opening A (mm)	Over Base B (mm)	Depth C (mm)	Loading (TONS)	Specifications
MC - 210 A R1 DI (MD)	600Sq	760Sq	75	12.5	B S - EN 124
MC - 210 A R1 DI (HD)	600Sq	760Sq	75	40	B S - EN 124

Hinged and Lockable Medium and Heavy Duty Grey Cast Iron Covers and Frames

Features:-

- Closed Keyholes
- Hinged Cover
- One Locking Bolt
- Single Seal

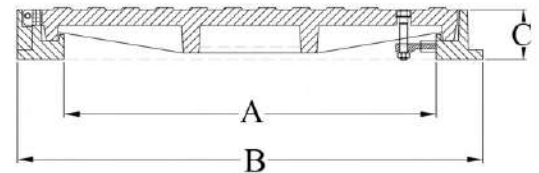
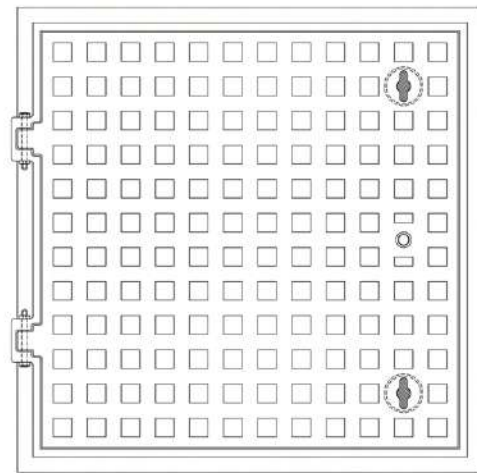

Product Code	Clear Opening A (mm)	Over Base B (mm)	Depth C (mm)	Loading (TONS)	Specifications
MC - 210 HR1 L (MD)	600Sq	750Sq	80	12.5	B S - E N - 124
MC - 210 HR1 L (HD)	600Sq	750Sq	80	40	B S - E N - 124

Heavy Duty Grey Cast Iron Cover & Frames

Features:-

- Closed Keyholes
- Register
- Double Seal

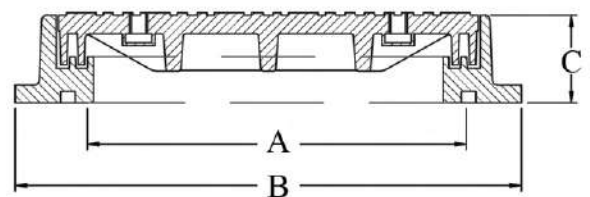
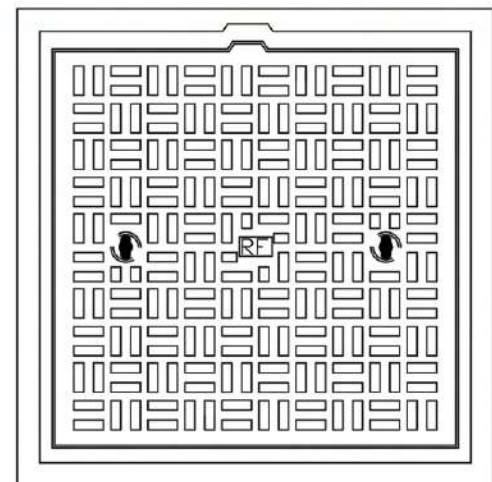

Product Code	Clear Opening A (mm)	Over Base B (mm)	Depth C (mm)	Loading (TONS)	Specifications
MC - 212 R1 (HD)	600Sq	810Sq	100	40	B S - E N - 124

Heavy Duty Ductile Cast Iron Covers & Frames

Features:-

- Closed Keyholes
- Register
- Single Seal

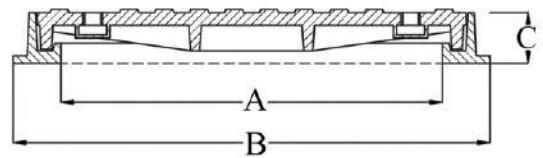
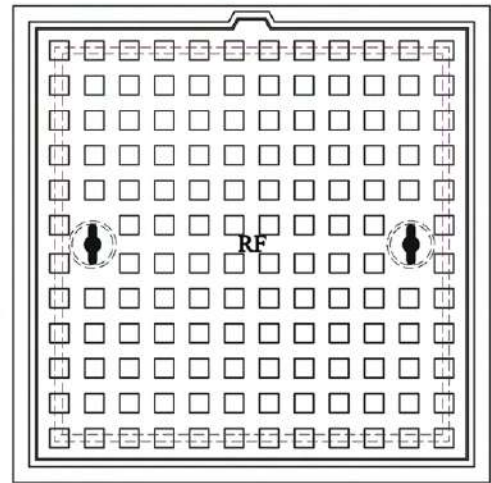

Product Code	Clear Opening A (mm)	Over Base B (mm)	Depth C (mm)	Loading (TONS)	Specifications
MC - 213 DI (HD)	600Sq	750Sq	80	40	BS - EN - 124

Light, Medium and Heavy Duty Grey Cast Iron Covers & Frames

Features:-

- Closed Keyholes
- Register
- Double Seal

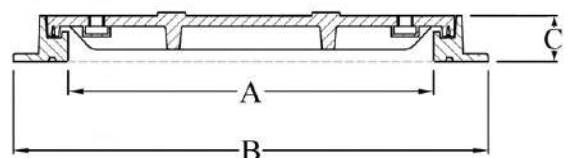
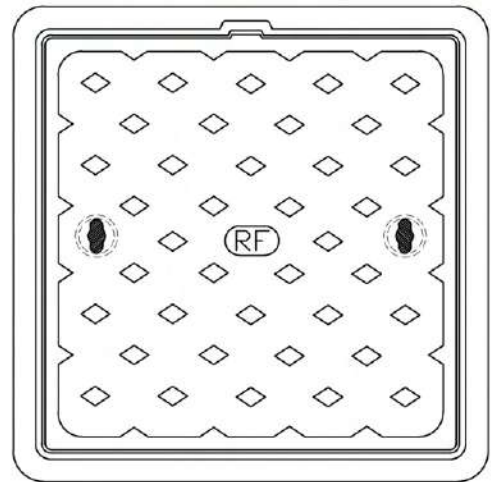

Product Code	Clear Opening A (mm)	Over Base B (mm)	Depth C (mm)	Loading (TONS)	Specifications
MC - 215 (LD)	600Sq	780Sq	50	1.5	BS - EN - 124
MC - 215 (MD)	600Sq	810Sq	80	12.5	BS - EN - 124
MC - 215 (HD)	600Sq	810Sq	100	40	BS - EN - 124



Heavy Duty Ductile Cast Iron Covers & Frames

Features:-

- Closed Keyholes
- Double Seal

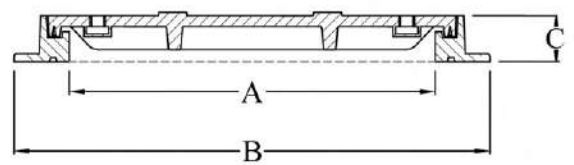
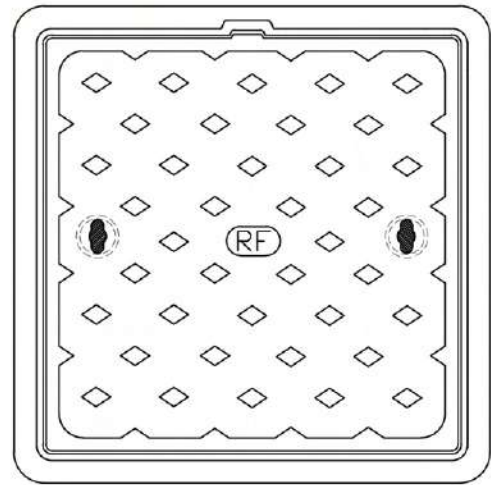

Product Code	Clear Opening A (mm)	Over Base B (mm)	Depth C (mm)	Loading (TONS)	Specifications
MC - 215 RDI (HD)	600Sq	810Sq	80	40	B S - E N - 124

Light, Medium and Heavy Duty Ductile Cast Iron Covers & Frames

Features:-

- Closed Keyholes
- Cover Secured to Frame
- Double Seal
- Rubber Gasket

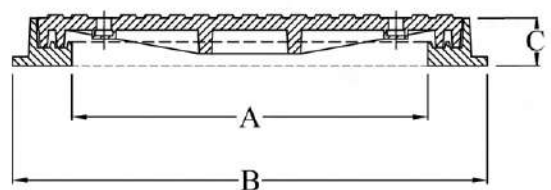
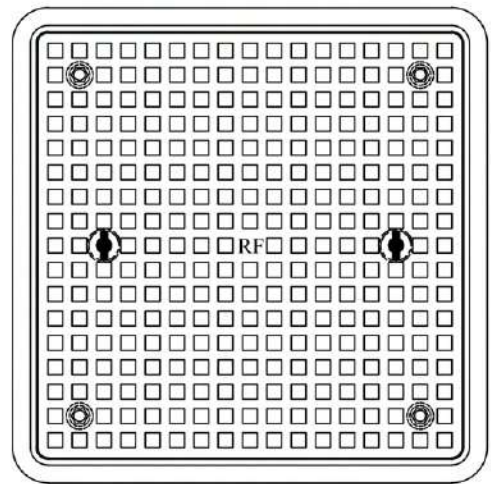

Product Code	Clear Opening A (mm)	Over Base B (mm)	Depth C (mm)	Loading (TONS)	Specifications
MC - 225 S R2 DI (LD)	600Sq	800Sq	80	1.5	B S - E N - 124
MC - 225 S R2 DI (MD)	600Sq	800Sq	80	12.5	B S - E N - 124
MC - 225 S R2 DI (HD)	600Sq	800Sq	80	40	B S - E N - 124

Light and Medium Ductile Cast Iron Covers & Frames

Features:-

- Closed Keyholes
- Register
- Single Seal

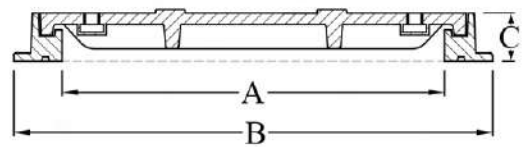
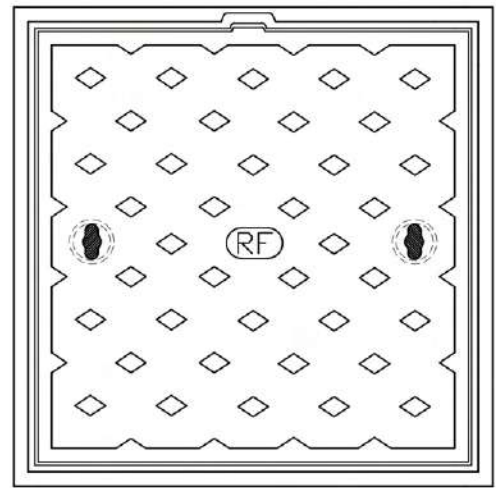

Product Code	Clear Opening A (mm)	Over Base B (mm)	Depth C (mm)	Loading (TONS)	Specifications
MC - 240 DI (LD)	600Sq	700Sq	50	1.5	BS - EN - 124
MC - 240 DI (MD)	600Sq	700Sq	75	12.5	BS - EN - 124

Medium and Heavy Duty Ductile Cast Iron Covers & Frames

Features:-

- Closed Keyholes
- Single Seal
- Four Prising Slots
- Foundation Bolt Slots

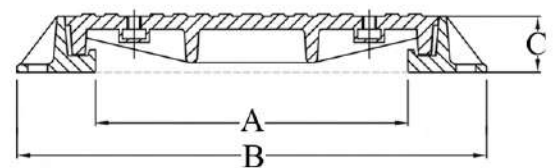
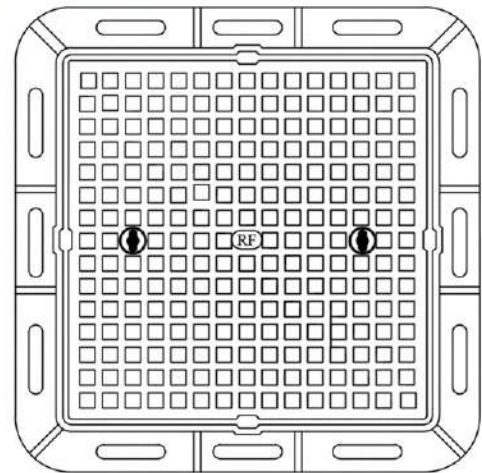

Product Code	Clear Opening A (mm)	Over Base B (mm)	Depth C (mm)	Loading (TONS)	Specifications
MC - 240 R1 DI (MD)	600Sq	760Sq	80	12.5	BS - EN - 124
MC - 240 R1 DI (HD)	600Sq	760Sq	80	40	BS - EN - 124



Heavy Duty Ductile Iron Covers & Frames

Features:-

- Register
- Closed Keyholes
- Rubber Gasket
- Single Seal

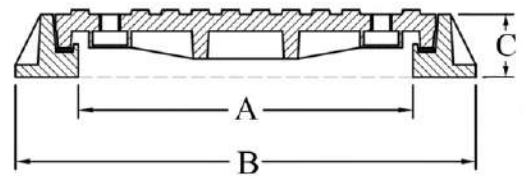
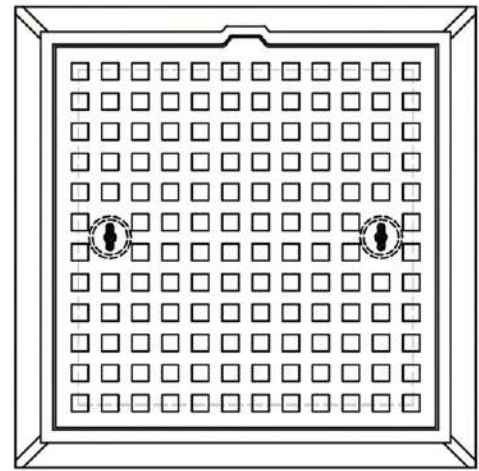

Product Code	Clear Opening A (mm)	Over Base B (mm)	Depth C (mm)	Loading (TONS)	Specifications
MC - 241 SS R1 DI (HD)	650Sq	800Sq	80	40	BS - EN - 124

Heavy Duty Grey Cast Iron Cover & Frames

Features:-

- Double Triangular
- Three Point Suspension
- Closed Keyholes
- Four Prising Slots

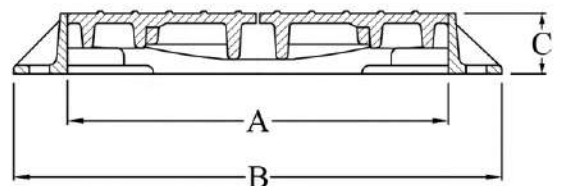
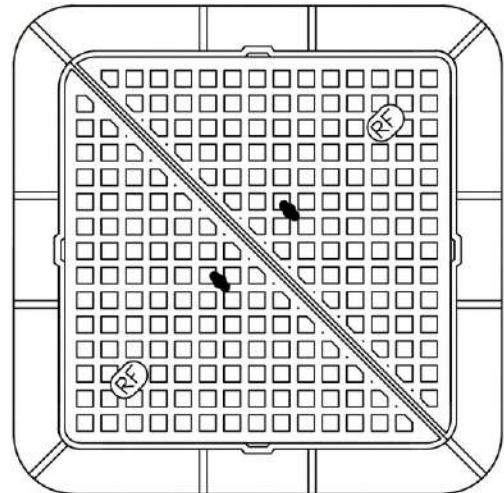

Product Code	Clear Opening A (mm)	Over Base B (mm)	Depth C (mm)	Loading (TONS)	Specifications
MC - 675 x 675 DT (HD)	675Sq	835Sq	100	40	BS - EN 124

Heavy Duty Ductile Cast Iron Covers and Frames

Features:-

- Closed Keyholes
- Double Triangular
- Three Point Suspension
- Four Prising Slots

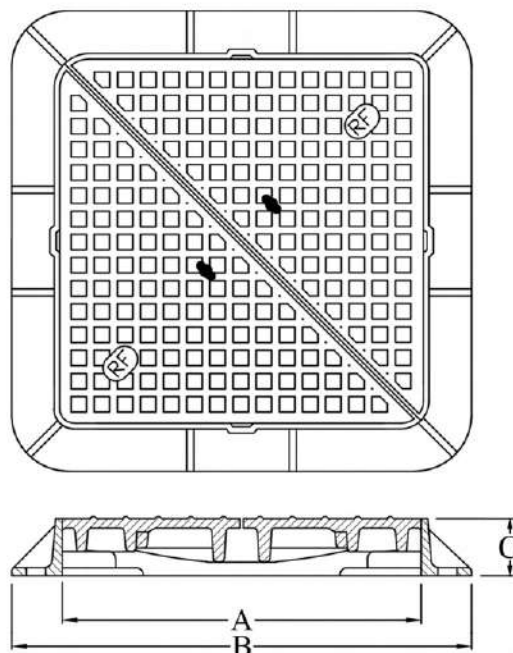

Product Code	Clear Opening A (mm)	Over Base B (mm)	Depth C (mm)	Loading (TONS)	Specifications
MC - 675 X 675 DT DI (HD)	675Sq	835Sq	100	40	B S - E N 124

Light, Medium and Heavy Duty Grey Cast Iron Covers & Frames

Features:-

- Four Closed Keyholes
- Register
- Single Seal

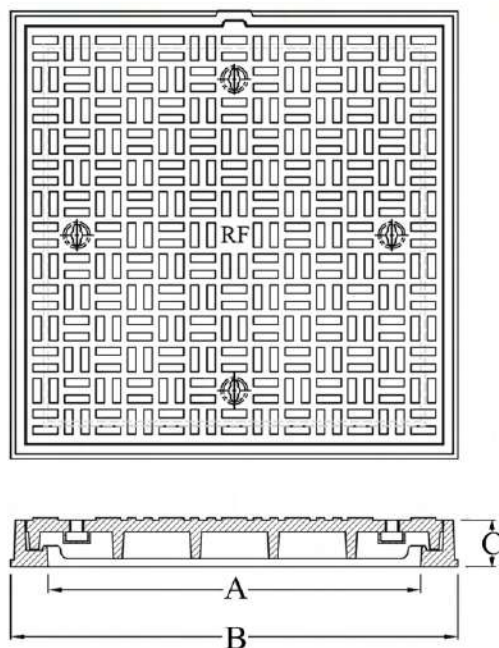

Product Code	Clear Opening A (mm)	Over Base B (mm)	Depth C (mm)	Loading (TONS)	Specifications
MC - 250 (LD)	700Sq	850Sq	100	1.5	B S - E N 124
MC - 250 (MD)	700Sq	850Sq	100	12.5	B S - E N 124
MC - 250(HD)	700Sq	850Sq	100	40	B S - E N 124



Heavy Duty Ductile Iron Double Triangular Covers and Frames

Features:-

- Twin Double Cover
- Closed Keyholes
- Three Point Suspension

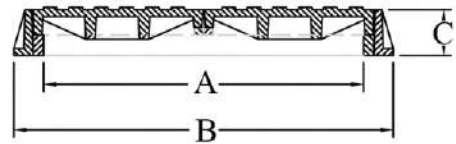
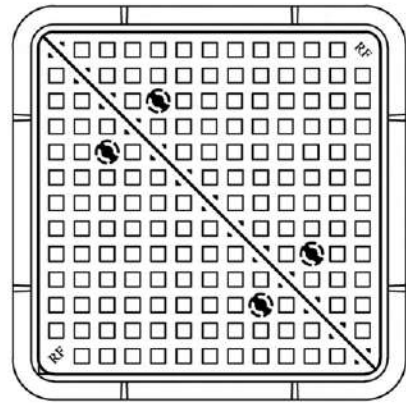

Product Code	Clear Opening A (mm)	Over Base B (mm)	Depth C (mm)	Loading (TONS)	Specifications
MC - 250 DI DT (HD)	700Sq	860Sq	100	40	B S - EN 124

Heavy Duty Grey Cast Iron Cover & Frames

Features:-

- Double Seal
- Register
- Four Closed Keyholes

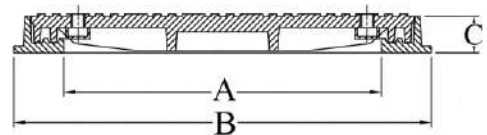
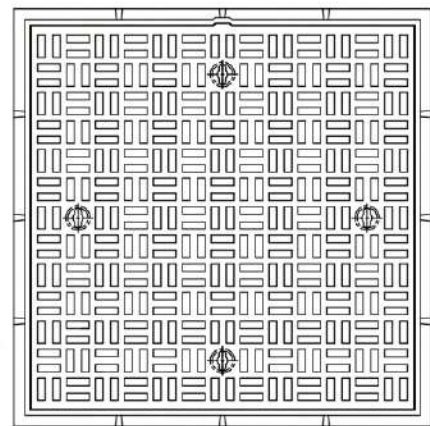

Product Code	Clear Opening A (mm)	Over Base B (mm)	Depth C (mm)	Loading (TONS)	Specifications
MC - 250 D S (HD)	700Sq	920Sq	80	40	B S - EN 124

Medium and Heavy Duty Grey Cast Iron Covers & Frames

Features:-

- Four Closed Keyholes
- Register
- Single Seal

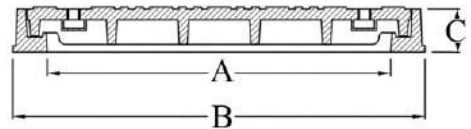
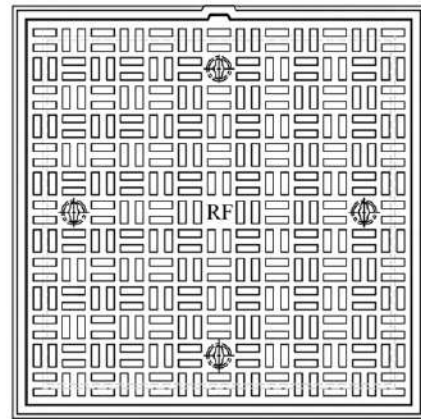

Product Code	Clear Opening A (mm)	Over Base B (mm)	Depth C (mm)	Loading (TONS)	Specifications
MC - 242 (HD)	750Sq	900Sq	100	40	B S - EN 124
MC - 251 (MD)	750Sq	920Sq	100	12.5	B S - EN 124

Heavy Duty Ductile Cast Iron Covers & Frames

Features:-

- Register
- Closed Keyholes

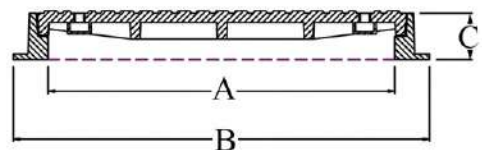
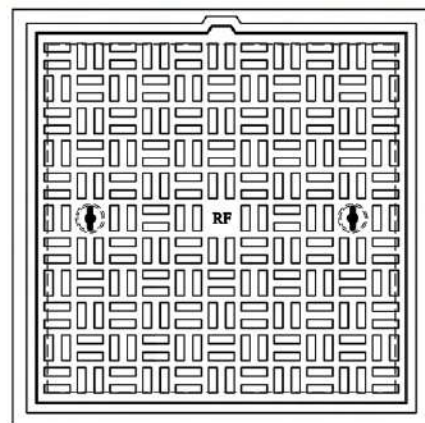

Product Code	Clear Opening A (mm)	Over Base B (mm)	Depth C (mm)	Loading (TONS)	Specifications
MC - 252 DI (HD)	750Sq	900Sq	100	40	B S - E N - 124

Medium and Heavy Duty Grey Cast Iron Covers & Frames

Features:-

- Closed Keyholes
- Cover Secured to Frame
- Single Seal
- Water Tight

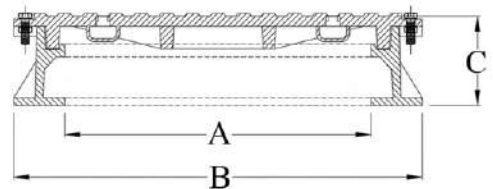
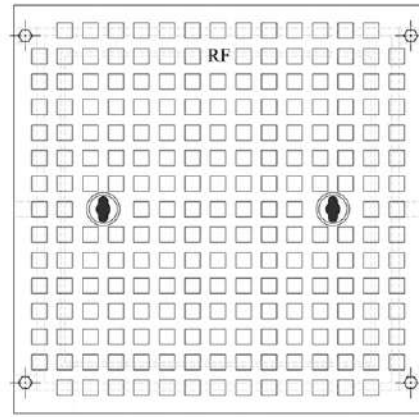

Product Code	Clear Opening A (mm)	Over Base B (mm)	Depth C (mm)	Loading (TONS)	Specifications
MC - 255 RWT (MD)	800Sq	1000Sq	175	12.5	B S - E N 124
MC - 255 RWT (HD)	800Sq	1000Sq	175	40	B S - E N 124

Hinged and Lockable Medium and Heavy Duty Grey Cast Iron Covers and Frames

Features:-

- Closed Keyholes
- Hinged Cover
- One Locking Bolt
- Single Seal

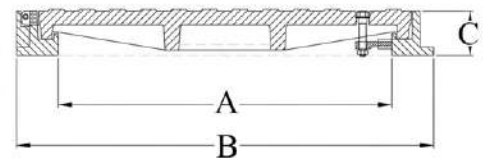
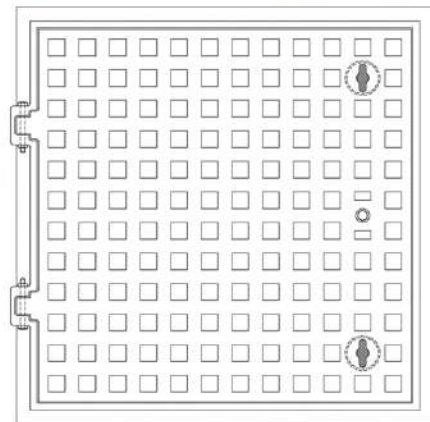

Product Code	Clear Opening A (mm)	Over Base B (mm)	Depth C (mm)	Loading (TONS)	Specifications
MC - 255 HR1 L (MD)	800Sq	960Sq	100	12.5	B S - E N - 124
MC - 255 HR1 L (HD)	800Sq	960Sq	100	40	B S - E N - 124

Light, Medium and Heavy Duty Grey Cast Iron Covers & Frames

Features:-

- Four Closed Keyholes
- Register
- Single Seal

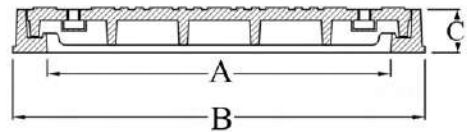
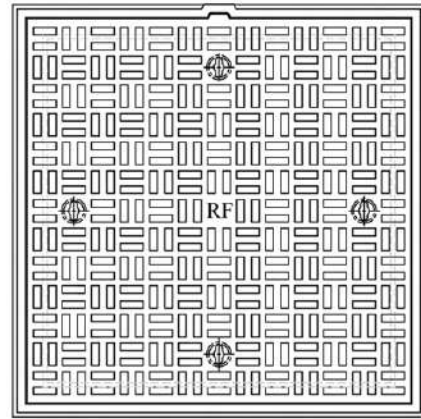

Product Code	Clear Opening A (mm)	Over Base B (mm)	Depth C (mm)	Loading (TONS)	Specifications
MC - 255 (LD)	800Sq	960Sq	100	1.5	BS - EN 124
MC - 255 (MD)	800Sq	960Sq	100	12.5	BS - EN 124
MC - 255 (HD)	800Sq	960Sq	100	40	BS - EN 124
MC - 255 A (MD)	800Sq	1100Sq	100	12.5	BS - EN 124
MC - 255 A (HD)	800Sq	1100Sq	100	40	BS - EN 124

Heavy Duty Grey Cast Iron Cover & Frames

Features:-

- Double Seal
- Register
- Four Closed Keyholes

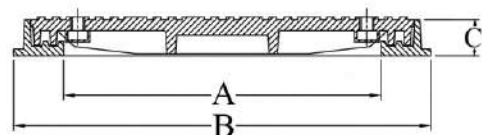
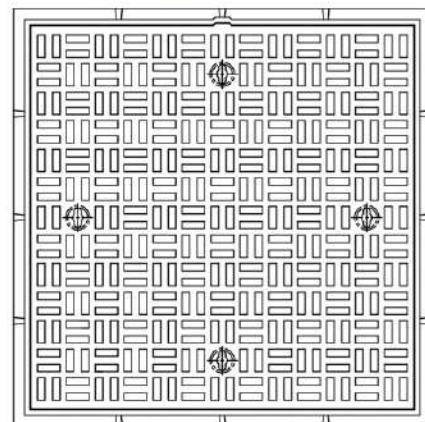

Product Code	Clear Opening A (mm)	Over Base B (mm)	Depth C (mm)	Loading (TONS)	Specifications
MC - 255 D S (HD)	800Sq	1050Sq	100	40	BS - EN 124

Light, Medium and Heavy Duty Grey Cast Iron Covers & Frames

Features:-

- Four Closed Keyholes
- Register
- Single Seal

Options:-

- Available with Locking Device
- MC - 260 (HD) Available with Plain Seated Frame
- MC - 260 LD is Square Checkers

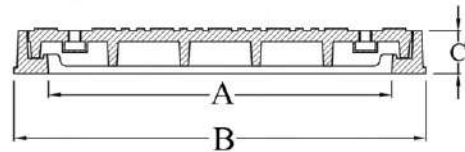
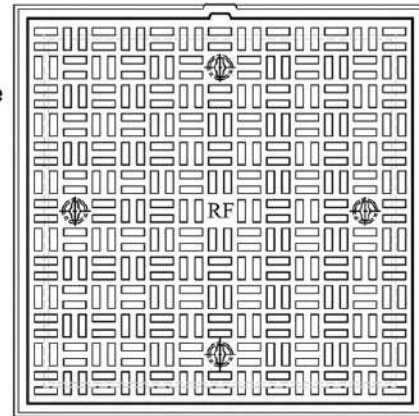

Product Code	Clear Opening A (mm)	Over Base B (mm)	Depth C (mm)	Loading (TONS)	Specifications
MC - 260 (LD)	900Sq	1100Sq	100	1.5	BS - EN 124
MC - 260 (MD)	900Sq	1100Sq	100	12.5	BS - EN 124
MC - 260 (HD)	900Sq	1100Sq	100	40	BS - EN 124

Medium and Heavy Duty Grey Cast Iron Covers & Frames

Features:-

- Double Seal
- Register
- Four Closed Keyholes

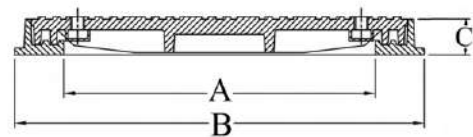
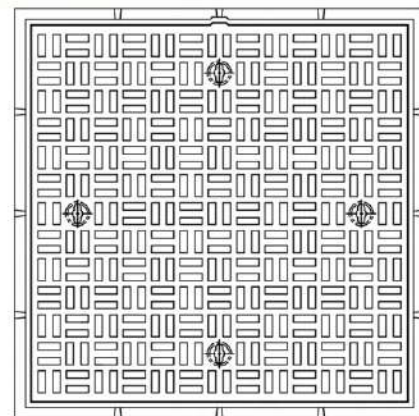

Product Code	Clear Opening A (mm)	Over Base B (mm)	Depth C (mm)	Loading (TONS)	Specifications
MC - 260 D S (MD)	900Sq	1120Sq	80	12.5	BS - EN 124
MC - 260 D S (HD)	900Sq	1120Sq	80	40	BS - EN 124
MC - 270 D S N (HD)	1000Sq	1250Sq	100	40	BS - EN 124

Heavy Duty Ductile Cast Iron Covers & Frames

Features:-

- Four Closed Keyholes
- Rubber Seal
- Single Seal
- Cover Secured to Frame
- WATE TIGHT

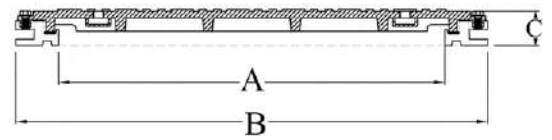
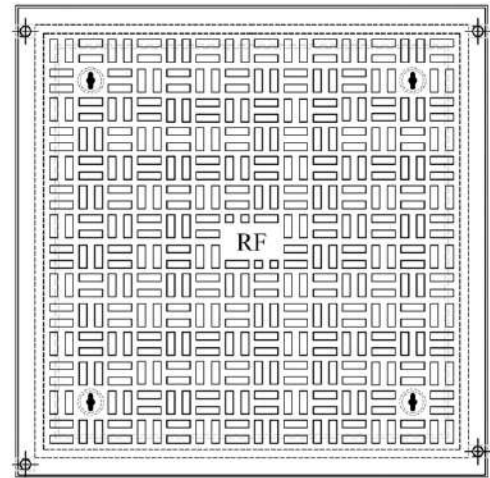

Product Code	Clear Opening A (mm)	Over Base B (mm)	Depth C (mm)	Loading (TONS)	Specifications
MC - 260 WT DI (HD)	900Sq	1100Sq	75	40	B S - E N - 124

Heavy Duty Ductile Cast Iron Covers & Frames

Features:-

- Closed Keyholes
- Register
- Four Foundation Bolt Holes

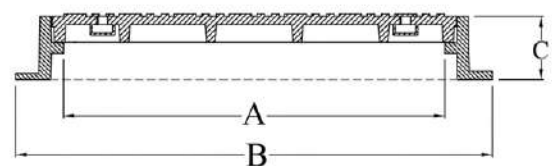
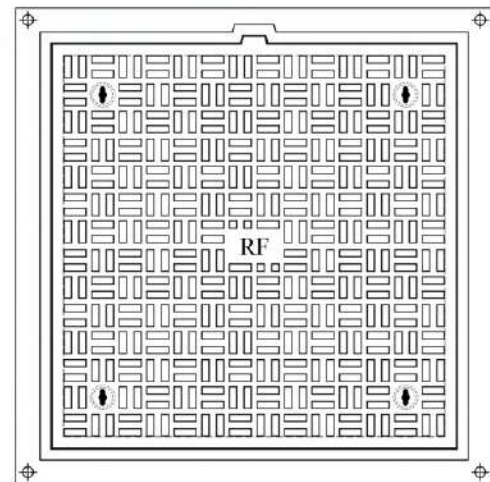

Product Code	Clear Opening A (mm)	Over Base B (mm)	Depth C (mm)	Loading (TONS)	Specifications
MC - 265 DI (HD)	900Sq	1125Sq	150	25	B S - E N - 124
MC - 266 R1 DI (HD)	900Sq	1125Sq	185	25	B S - E N - 124



Medium and Heavy Duty Grey Cast Iron Covers & Frames

Features:-

- Closed Keyholes
- Register
- Single Seal
- Four Holes For Anchoring

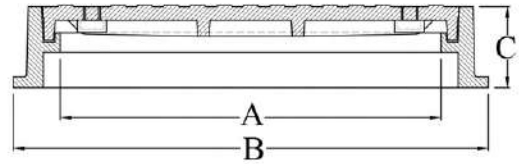
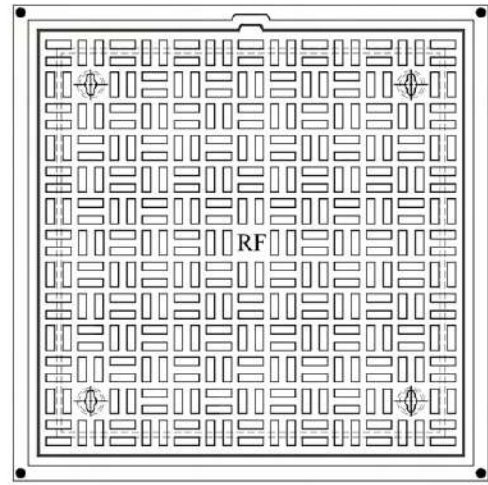

Product Code	Clear Opening A (mm)	Over Base B (mm)	Depth C (mm)	Loading (TONS)	Specifications
MC -265 (MD)	900Sq	1125Sq	150	12.5	B S - E N - 124
MC -265 (HD)	900Sq	1125Sq	150	40	B S - E N - 124
MC -266 (HD)	900Sq	1125Sq	185	40	B S - E N - 124

Heavy Duty Grey Cast Iron Covers & Frames (According to SEC-COA Specification)

Features:-

- Closed Keyholes
- Single Seal
- Rubber Gasket

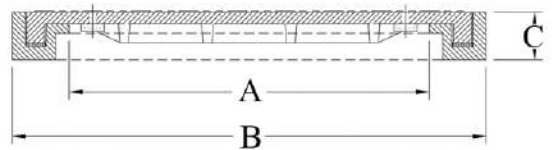
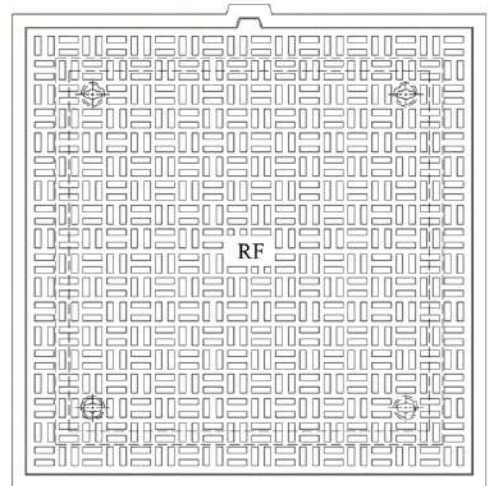

Product Code	Clear Opening A (mm)	Over Base B (mm)	Depth C (mm)	Loading (TONS)	Specifications
MC - 270 AR1 (HD)	950Sq	1250Sq	125	45	B S - E N - 124

Light, Medium and Heavy Duty Grey Cast Iron Covers & Frames

Features:-

- Closed Keyholes
- Register

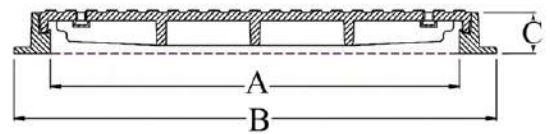
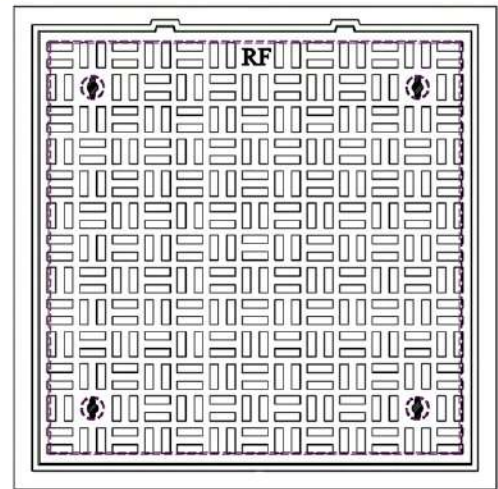

Product Code	Clear Opening A (mm)	Over Base B (mm)	Depth C (mm)	Loading (TONS)	Specifications
MC - 270 (LD)	1000Sq	1180Sq	100	1.5	BS - EN - 124
MC - 270 (MD)	1000Sq	1180Sq	100	12.5	BS - EN - 124
MC - 270 (HD)	1000Sq	1180Sq	100	40	BS - EN - 124

Heavy Duty Grey Cast Iron Covers & Frames

Features:-

- Covers Hinged
- Closed Keyholes
- Rubber Gasket
- Single Seal
- Locking Bolts

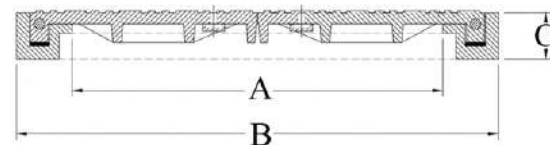
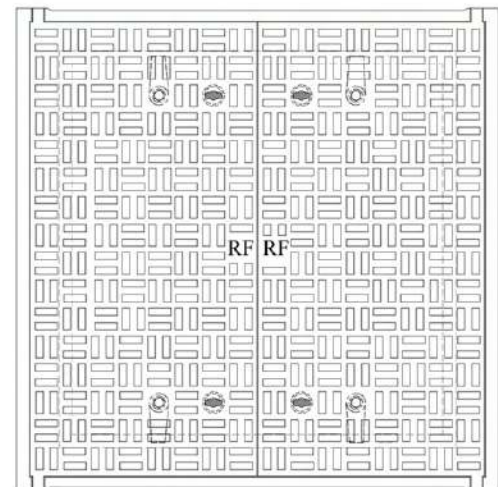

Product Code	Clear Opening A (mm)	Over Base B (mm)	Depth C (mm)	Loading (TONS)	Specifications
MC - 270 A R3 C2 (HD)	1000Sq	1300Sq	125	45	BS - EN - 124



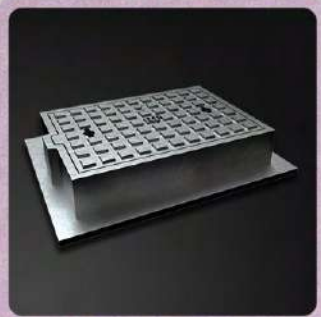

**RECTANGULAR SINGLE AND MULTIPLE
COVERS AND FRAMES**

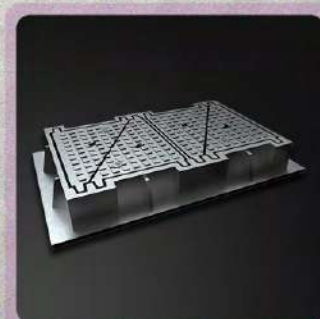

Heavy Duty Grey Cast Iron Covers & Frames

Features:-

- Register
- Closed Keyholes
- Locking Device

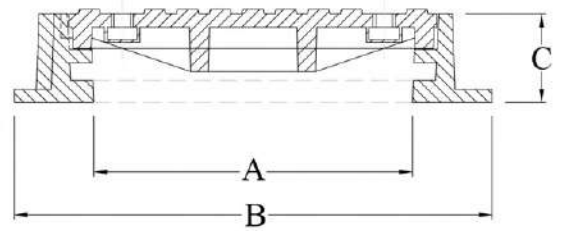
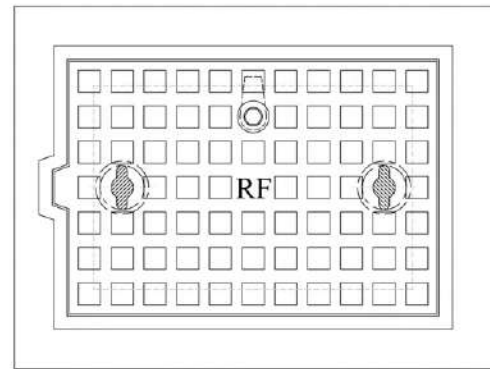

Product Code	Clear Opening A (mm)	Over Base B (mm)	Depth C (mm)	Loading (TONS)	Specifications
MC - 301 (HD)	360 X 230	540 X 410	100	40	BS - EN - 124

Medium Duty Ductile Cast Iron Covers & Frames

Features:-

- Closed Keyholes
- Register

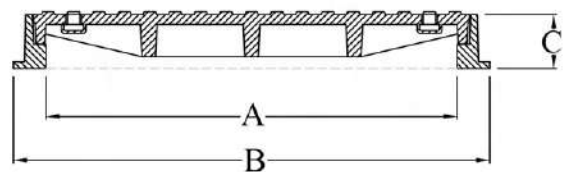
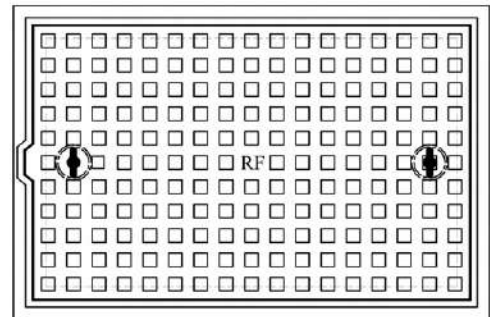

Product Code	Clear Opening A (mm)	Over Base B (mm)	Depth C (mm)	Loading (TONS)	Specifications
MC - 301 R5 DI (MD)	460 X 200	550 X 350	30	12.5	BS - EN - 124

Heavy Duty Grey Cast Iron Covers & Frames

Features:-

- Double Seal
- Closed Keyholes
- Two Prising Slots

Option:-

- Other designs are available with sharp edges

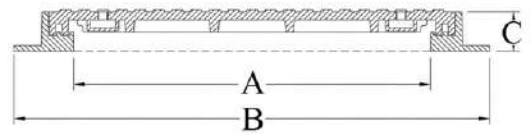
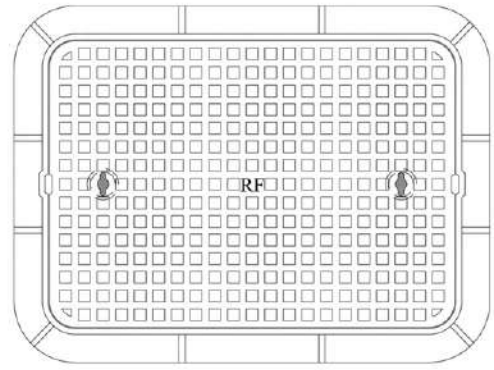

Product Code	Clear Opening A (mm)	Over Base B (mm)	Depth C (mm)	Loading (TONS)	Specifications
MC - 307 (HD)	700x500	860x660	125	40	BS - EN - 124

Medium and Heavy Duty Grey Cast Iron Covers & Frames

Features:-

- Closed Keyholes
- Register

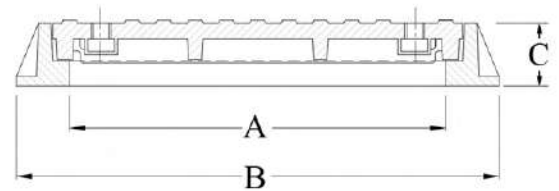
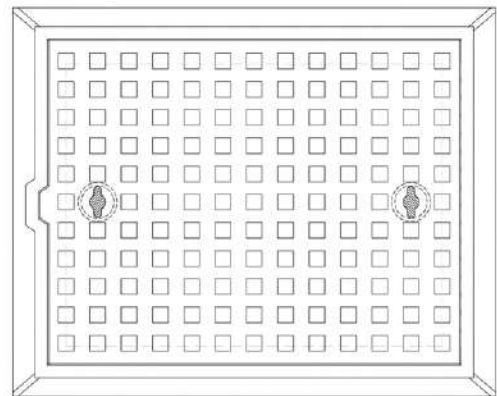

Product Code	Clear Opening A (mm)	Over Base B (mm)	Depth C (mm)	Loading (TONS)	Specifications
MC - 304 R4(HD)	600 X 400	740 X 540	75	40	BS - EN - 124
MC - 300 (MD)	600 X 450	770 X 620	100	12.5	BS - EN - 124
MC - 300 (HD)	600 X 450	770 X 620	100	40	BS - EN - 124

Light Medium and Heavy Duty Ductile Cast Iron Covers & Frames

Features:-

- Closed Keyholes
- Register

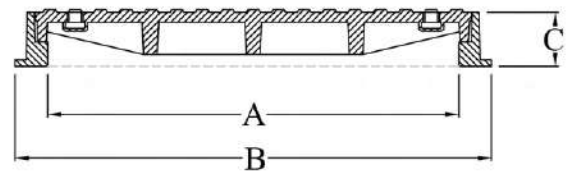
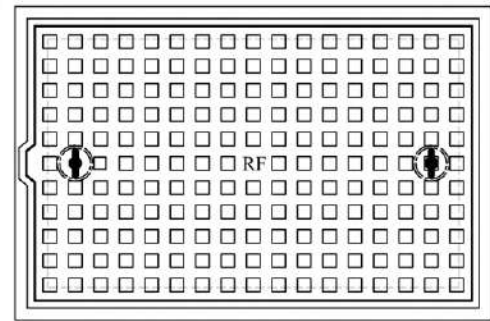

Product Code	Clear Opening A (mm)	Over Base B (mm)	Depth C (mm)	Loading (TONS)	Specifications
MC - 472 AR DI (HD)	625 X 750	825 X 950	100	40	BS - EN - 124

Heavy Duty Ductile Iron Kerb Covers & Frames

Features:-

- Side Kerb Inlet
- Closed Keyholes

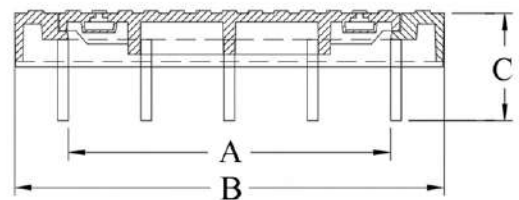
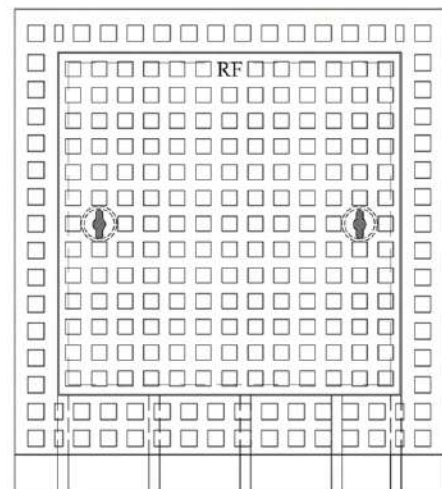

Product Code	Clear Opening A (mm)	Over Base B (mm)	Depth C (mm)	Loading (TONS)	Specifications
MC - 315 DI M R3 / 200/ 40 (HD)	600 Sq	800 x 830	100 / 200	40	BS - EN - 124



Medium and Heavy Duty Grey Cast Iron Covers & Frames

Features:-

- Closed Keyholes
- Register

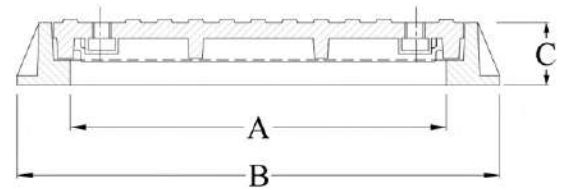
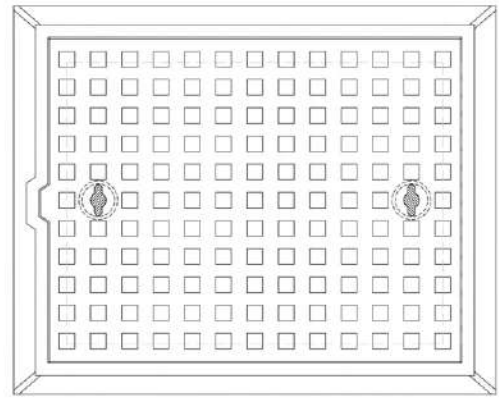

Product Code	Clear Opening A (mm)	Over Base B (mm)	Depth C (mm)	Loading (TONS)	Specifications
MC - 305 (MD)	750 X 600	970 X 820	130	12.5	BS - EN - 124
MC - 305 (HD)	750 X 600	970 X 820	130	40	BS - EN - 124
MC - 304 (HD)	760 X 420	860 X 520	75	40	BS - EN - 124

Light Medium and Heavy Duty Ductile Cast Iron Covers & Frames

Features:-

- Closed Keyholes
- Register

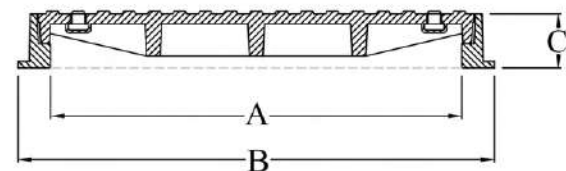
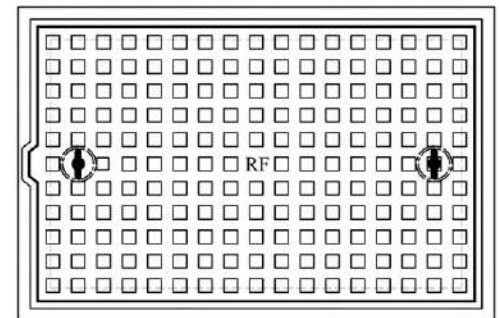

Product Code	Clear Opening A (mm)	Over Base B (mm)	Depth C (mm)	Loading (TONS)	Specifications
MC - 305 A2 DI (LD)	760 X 460	880 X 580	100	1.5	BS - EN - 124
MC - 305 A2 DI (MD)	760 X 460	880 X 580	100	12.5	BS - EN - 124
MC - 305 A2 DI (HD)	760 X 460	880 X 580	100	40	BS - EN - 124

Medium and Heavy Duty Grey Cast Iron Covers & Frames

Features:-

- Double Seal
- Closed Keyholes
- Two Prising Slots

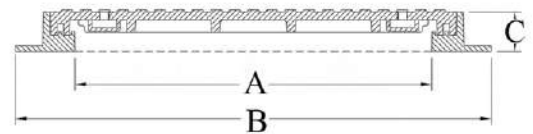
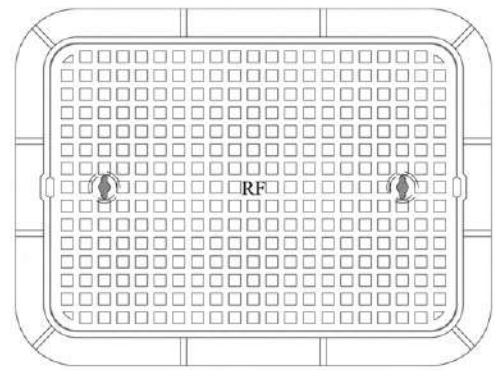

Product Code	Clear Opening A (mm)	Over Base B (mm)	Depth C (mm)	Loading (TONS)	Specifications
MC - 310 DS (MD)	900 X 600	1200 X 900	100	12.5	BS - EN - 124
MC - 310 DS (HD)	900 X 600	1200 X 900	100	40	BS - EN - 124

Medium, Heavy and Extra Heavy Duty Grey Cast Iron Covers & Frames

Features:-

- Closed Keyholes
- Register
- Single Seal
- Four Holes for Anchoring

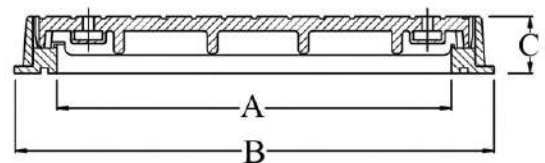
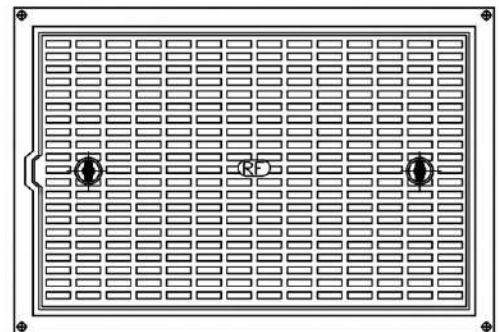

Product Code	Clear Opening A (mm)	Over Base B (mm)	Depth C (mm)	Loading (TONS)	Specifications
MC - 310 (MD)	900 X 600	1100 X 830	100	12.5	BS - EN - 124
MC - 310 (HD)	900 X 600	1100 X 830	150	40	BS - EN - 124
MC - 310 E (HD)	900 X 600	1100 X 830	150	60	BS - EN - 124



Heavy Duty Grey Cast Iron Covers & Frames

Features:-

- Register
- Closed Keyholes
- Four Holes for Anchoring

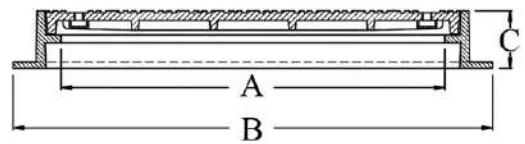
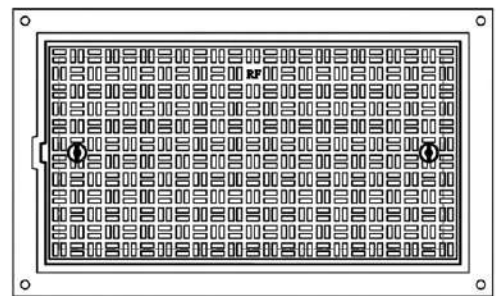

Product Code	Clear Opening A (mm)	Over Base B (mm)	Depth C (mm)	Loading (TONS)	Specifications
MC - 315 (HD)	900 X 600	1130 X 830	185	40	BS - EN - 124

Medium Duty Grey Cast Iron Covers & Frames

Features:-

- Covers Hinged
- Closed Keyholes
- Cover Secured to Frame

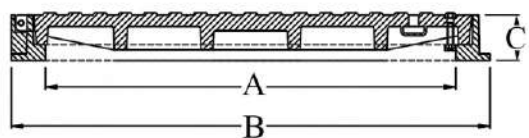
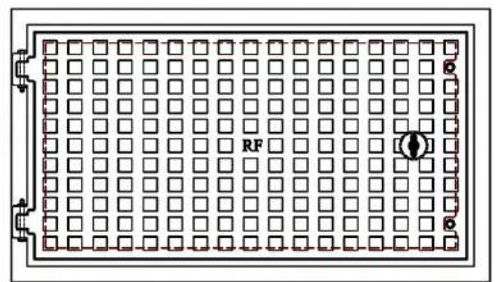

Product Code	Clear Opening A (mm)	Over Base B (mm)	Depth C (mm)	Loading (TONS)	Specifications
MC - 316 HR1 (MD)	900 X 450	1050 X 600	100	12.5	BS - EN - 124

Heavy Duty Grey Cast Iron Covers & Frames

Features:-

- Register
- Closed Keyholes

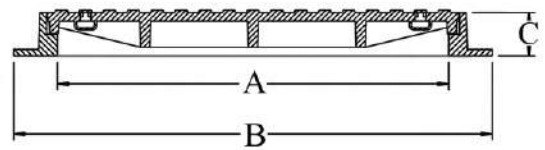
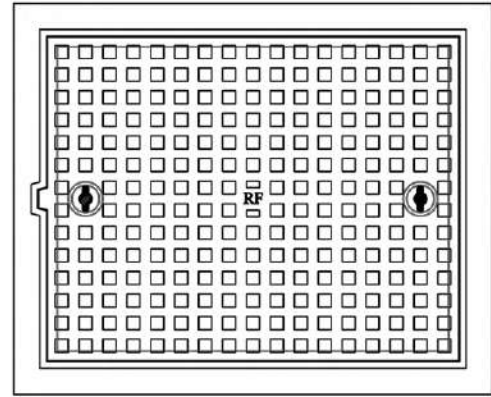

Product Code	Clear Opening A (mm)	Over Base B (mm)	Depth C (mm)	Loading (TONS)	Specifications
MC - 318 R2 (HD)	900 X 700	1100 X 900	100	40	B S - E N - 124

Heavy Duty Grey Cast Iron Multiple Covers With Single Frame

Features:-

- Two Closed Keyholes on each Cover
- Two Locking Bolts on each Cover
- Cover Hinged (Both)

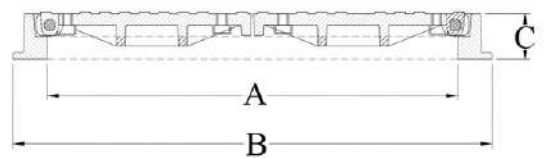
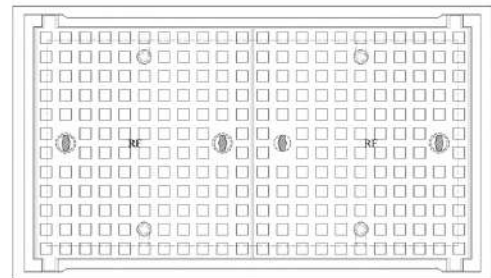

Product Code	Clear Opening A (mm)	Over Base B (mm)	Depth C (mm)	Loading (TONS)	Specifications
MC - 355 (HD)	900 X 450	1060 X 610	100	40	B S - E N - 124
MC - 355 R1 (HD)	900 X 450	1050 X 600	100	40	B S - E N - 124



Heavy Duty Grey Cast Iron Covers & Frames

Features:-

- Closed Keyhole
- Register
- Two Locking Device
- Prsing Slots

Options:-

- Open Keyholes

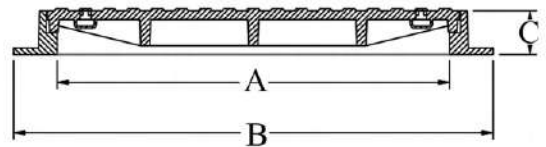
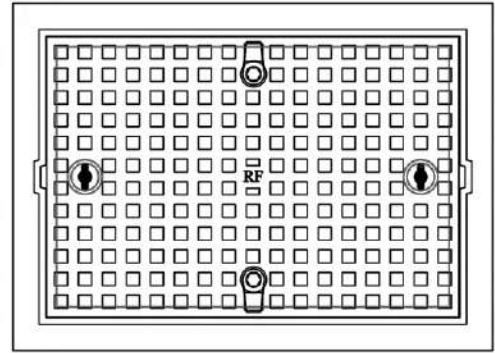

Product Code	Clear Opening A (mm)	Over Base B (mm)	Depth C (mm)	Loading (TONS)	Specifications
MC - 318 R4 (HD)	1000 X 600	1180 X 780	100	40	B S - E N - 124

Heavy Duty Grey Cast Iron Covers & Kerb Gully Frame

Features:-

- Side Inlets
- Closed Keyholes

For
RIYADH MUNICIPALITY

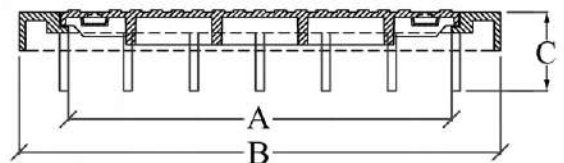
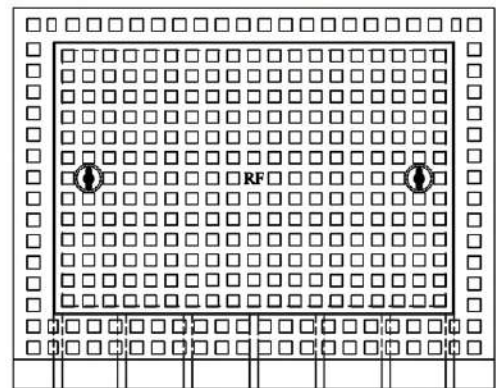
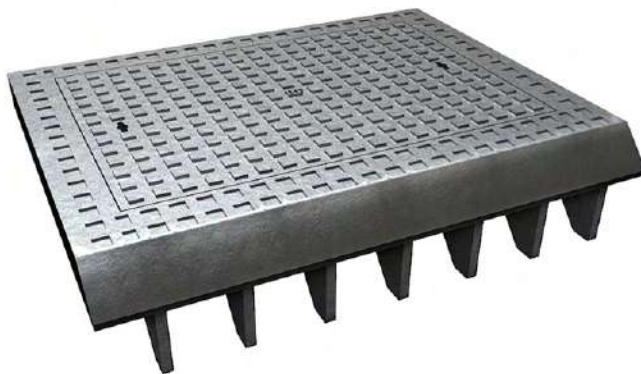

Product Code	Clear Opening A (mm)	Over Base B (mm)	Depth C (mm)	Loading (TONS)	Specifications
MC - 315 R (HD)	1000 X 600	1200 X 900	250	40	B S - E N - 124

Heavy Duty Grey Cast Iron Multiple Covers with Single Frame

Features:-

- Two Closed Keyholes on each Cover

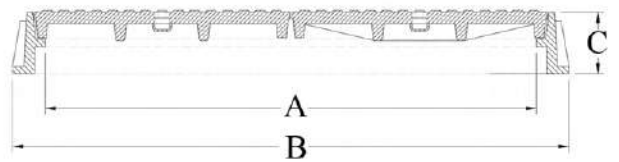
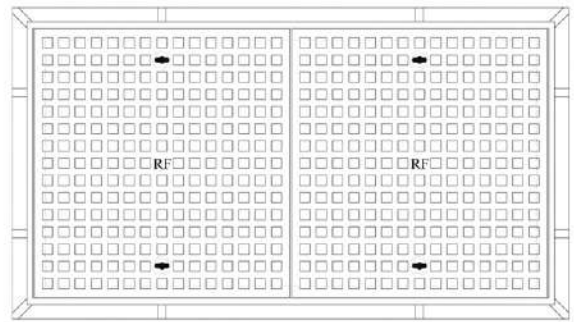

Product Code	Clear Opening A (mm)	Over Base B (mm)	Depth C (mm)	Loading (TONS)	Specifications
MC - 354 A R2 C2 (HD)	1000 X 600	1200 X 800	100	40	BS - EN - 124

Medium Duty Grey Cast Iron Covers & Frames

Features:-

- Register
- Closed Keyholes

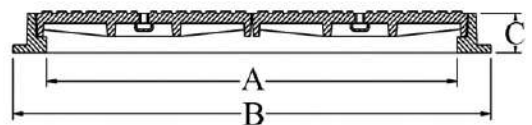
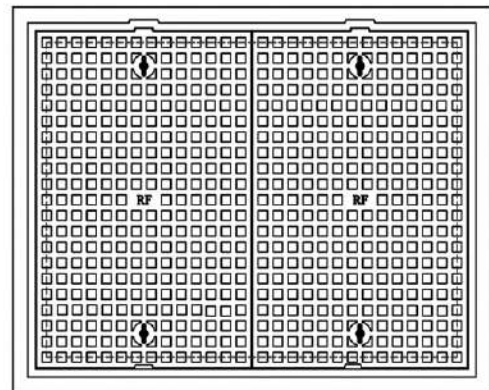

Product Code	Clear Opening A (mm)	Over Base B (mm)	Depth C (mm)	Loading (TONS)	Specifications
MC - 351 M R5 (MD)	1050 X 950	1220 X 1120	75	12.5	BS - EN - 124

Light Medium and Heavy Duty Grey Cast Iron Multiple Covers & Frames

Features:-

- Single Seal
- One Register for each Cover
- Two Closed Keyholes for each Cover

Options:-

- Rubber Gasket

MC - 358 R2 C2 (LD,MD and HD) for ROYAL COMMISSION PROJECT

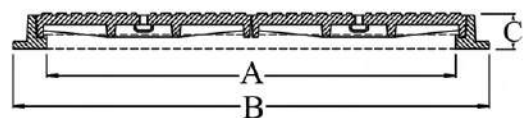
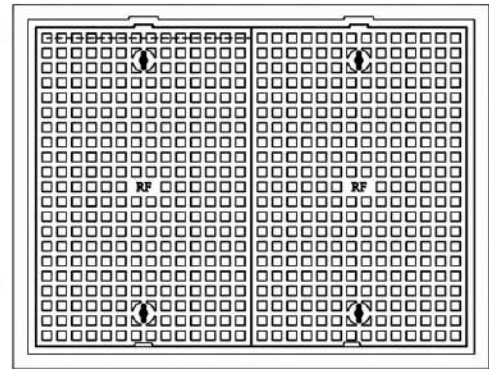

Product Code	Clear Opening A (mm)	Over Base B (mm)	Depth C (mm)	Loading (TONS)	Specifications
MC - 351 R3 (HD)	1100 X 800	1300 X 1000	100	40	BS - EN - 124
MC - 358 R2 C2 (LD)	1100 X 580	1240 X 720	100	1.5	BS - EN - 124
MC - 358 R2 C2 (MD)	1100 X 580	1240 X 720	100	12.5	BS - EN - 124
MC - 358 R2 C2 (HD)	1100 X 580	1240 X 720	100	40	BS - EN - 124

Heavy Duty Grey Cast Iron Covers & Kerb Gully Frame

Features:-

- Side Inlets
- Closed Keyholes

For RIYADH MUNICIPALITY

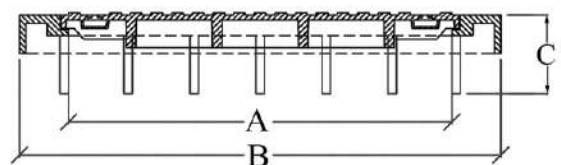
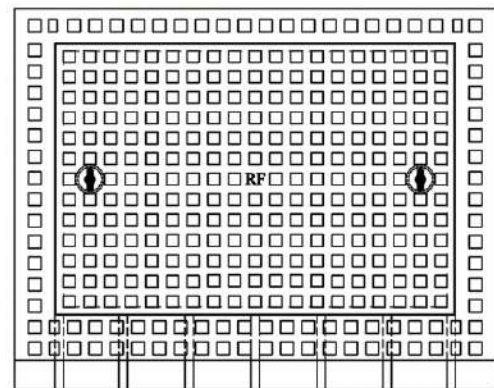
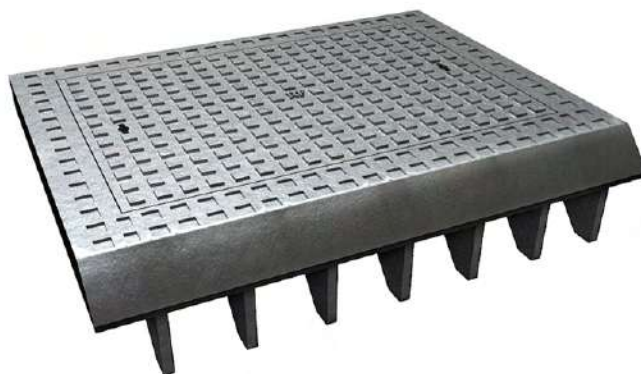

Product Code	Clear Opening A (mm)	Over Base B (mm)	Depth C (mm)	Loading (TONS)	Specifications
MC - 315 R M4 (HD)	1200 X 600	1400 X 900	250	25	BS - EN - 124



Medium and Heavy Duty Ductile Cast Iron Multiple Covers with Single Frames

Features:-

- Two Closed Keyholes for each Cover

Options:-

- Two Locking Device for each Cover

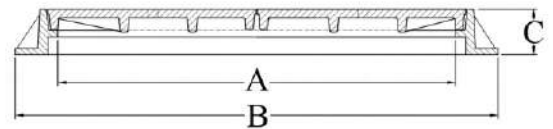
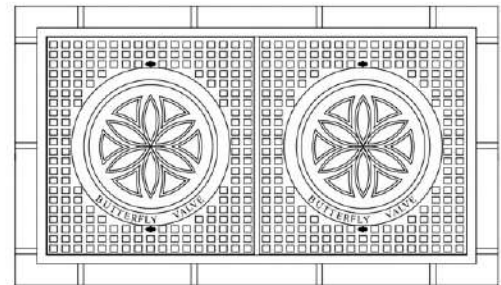

Product Code	Clear Opening A (mm)	Over Base B (mm)	Depth C (mm)	Loading (TONS)	Specifications
MC - 354 DIF (MD)	1200 X 600	1360 X 760	100	12.5	BS - EN - 124
MC - 354 DIF (HD)	1200 X 600	1360 X 760	100	40	BS - EN - 124

Heavy Duty Grey Cast Iron Multiple Covers With Single Frame

Features:-

- Two Closed Keyholes for each Cover

ROYAL COMMISSION PROJECT

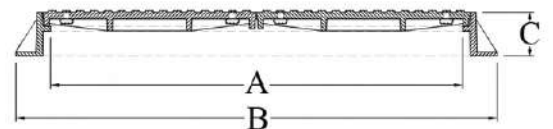
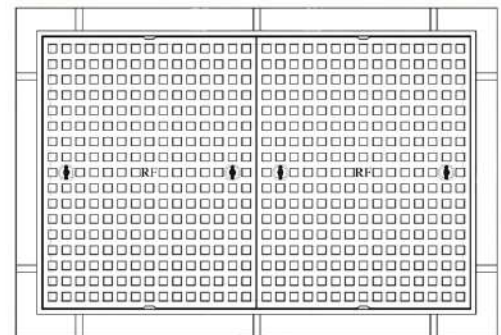

Product Code	Clear Opening A (mm)	Over Base B (mm)	Depth C (mm)	Loading (TONS)	Specifications
MC - 354 (HD)	1200 X 600	1360 X 760	100	40	BS - EN - 124



Heavy Duty Grey Cast Iron Multiple Covers with Single Frame

Features:-

- Two Closed Keyholes on each Cover

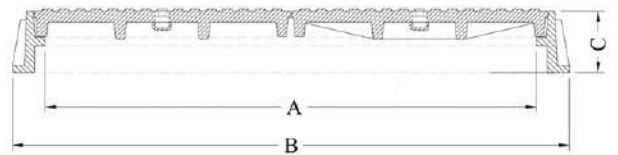
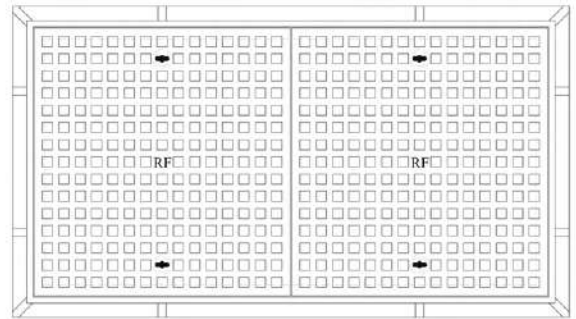

Product Code	Clear Opening A (mm)	Over Base B (mm)	Depth C (mm)	Loading (TONS)	Specifications
MC - 354 A R3 C2 (HD)	1200 X 600	1360 X 760	150	40	BS - EN - 124

Heavy Duty Grey Cast Iron Double Triangular Multiple Covers with Single Frames

Features:-

- Three Point Suspension
- Twin Double Triangular
- Closed Keyholes

Options:-

- GRP Sealing Plate

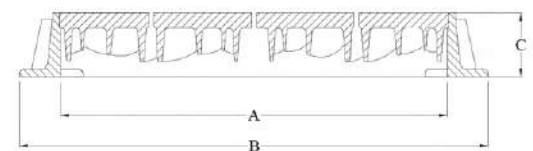
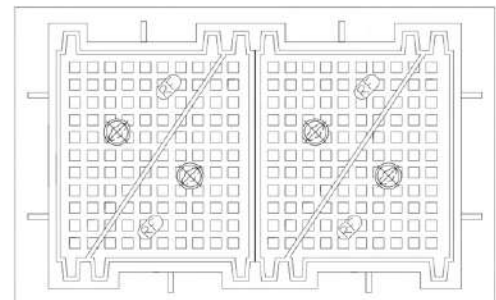

Product Code	Clear Opening A (mm)	Over Base B (mm)	Depth C (mm)	Loading (TONS)	Specifications
MC - 353 DT (HD)	1200 X 600	1500 X 900	180	40	BS - EN - 124
MC - 353 R1 DT (HD)	1200 X 675	1500 X 975	150	40	BS - EN - 124

Heavy Duty Grey Cast Iron Multiple Covers With Single Frame

Features:-

- Two Closed Keyholes for each Cover

ROYAL COMMISSION PROJECT

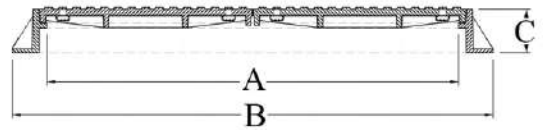
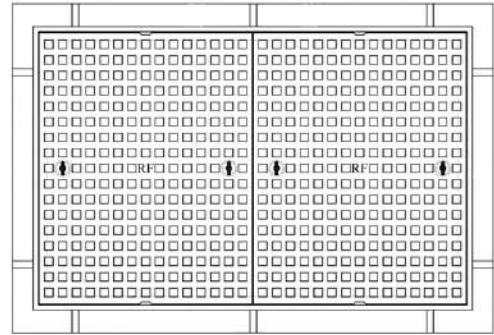

Product Code	Clear Opening A (mm)	Over Base B (mm)	Depth C (mm)	Loading (TONS)	Specifications
MC - 354 AR1 C2 (HD)	1220 X 760	1425 X 975	130	40	BS - EN - 124

Heavy Duty Grey Cast Iron (Class C 250) Inspection Chamber Cover and Kerb Gully Frame

Features:-

- Four Nos. Closed Keyholes

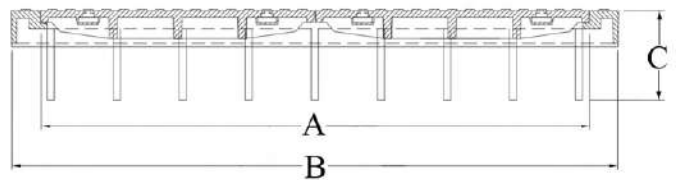
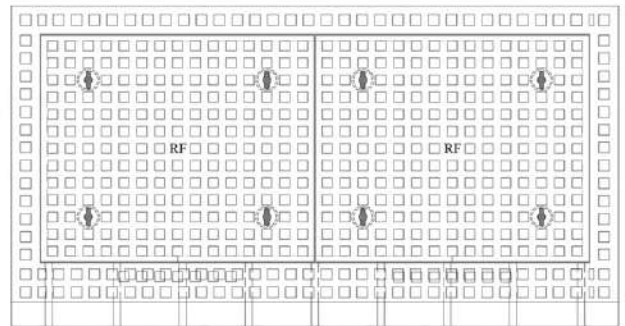

Product Code	Clear Opening A (mm)	Over Base B (mm)	Depth C (mm)	Loading (TONS)	Specifications
MC - 315 R M5 (HD)	1500 X 600	1700 X 900	250	25	BS - EN - 124



Heavy Duty Ductile Cast Iron Multiple Covers with Frame

Features:-

- Two Closed Keyholes on each Cover

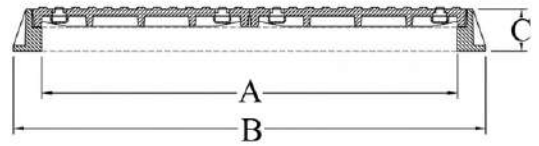
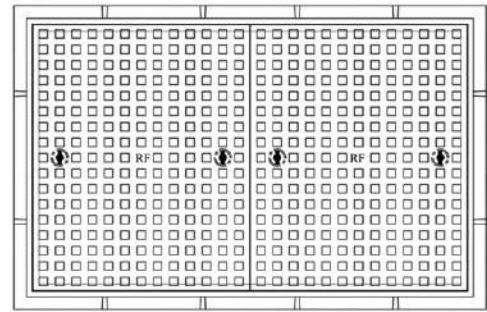

Product Code	Clear Opening A (mm)	Over Base B (mm)	Depth C (mm)	Loading (TONS)	Specifications
MC - 355 DI M R3 (HD)	1500 X 900	1680 X 1080	150	40	B S - E N - 124

Heavy Duty Ductile Cast Iron Multiple Covers with Side Frame

Features:-

- Closed Keyholes
- Locking Bolts

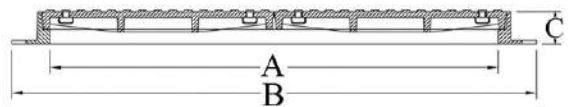
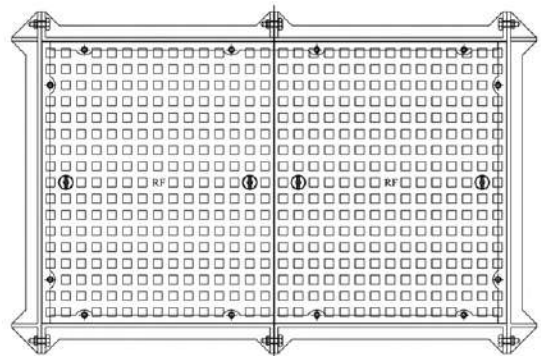

Product Code	Clear Opening A (mm)	Over Base B (mm)	Depth C (mm)	Loading (TONS)	Specifications
MC - 355 DI F R5 L (HD)	1520 X 900	1780 X 1160	110	90	B S - E N - 124

Heavy Duty Ductile Cast Iron Manhole Covers with Single Frame

Features:-

- Two closed keyholes on each cover

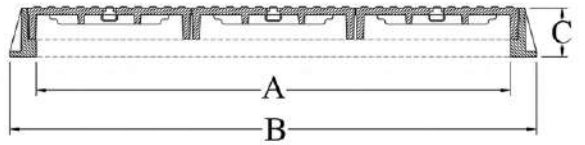
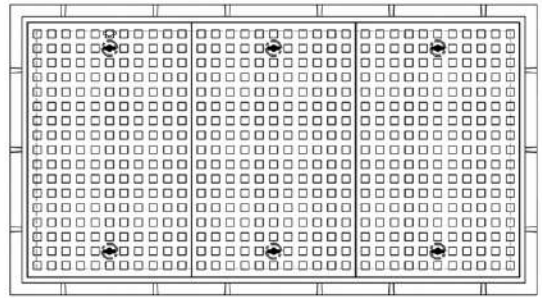

Product Code	Clear Opening A (mm)	Over Base B (mm)	Depth C (mm)	Loading (TONS)	Specifications
MC - 355 - 180 / 90 DI (HD)	1800 X 900	2000 X 1100	185	25	BS - EN 124

Heavy Duty Grey Cast Iron Multiple Covers with Single Frame

Features:-

- Two Closed Keyholes on each Cover

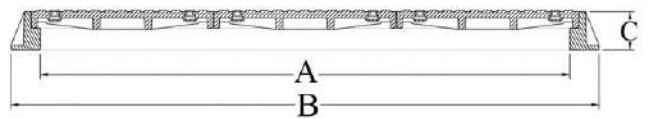
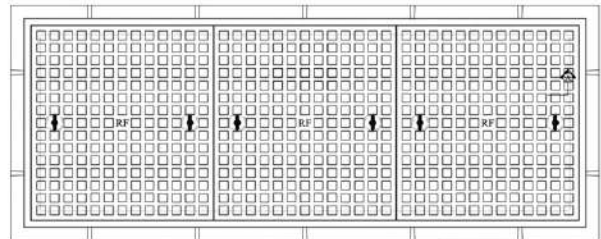

Product Code	Clear Opening A (mm)	Over Base B (mm)	Depth C (mm)	Loading (TONS)	Specifications
MC - 364 - 180 X 60 C3 (HD)	1800 X 600	2000 X 800	130	40	BS - EN - 124



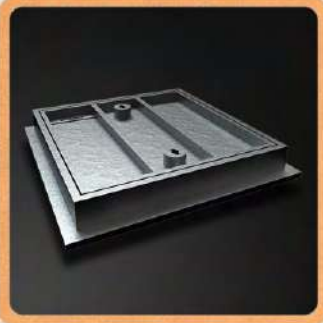

**RECESSED TOP SINGLE AND MULTIPLE
COVERS AND FRAMES**

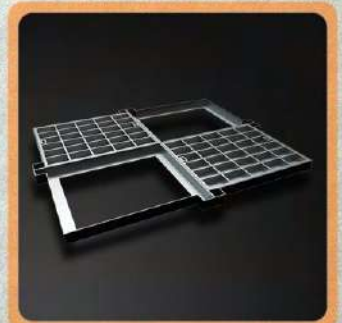

Light Medium and Heavy Duty Grey Cast Iron Recessed Top Covers and Frames

Features:-

- Closed Keyholes
- Two Prising Slots
- Inscription Plate Available Separately

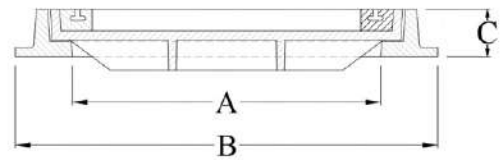
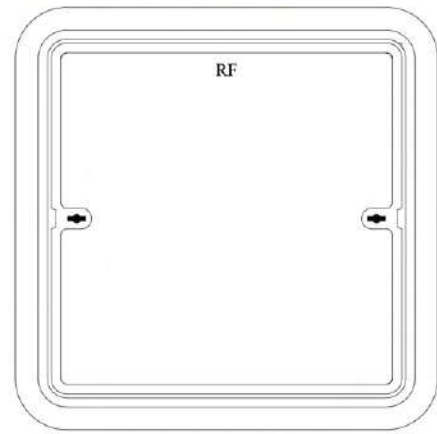

Product Code	Clear Opening A (mm)	Over Base B (mm)	Depth C (mm)	Loading (TONS)	Specifications
MC - 216 RC (LD)	400Sq	550Sq	75	1.5	B S - E N - 124
MC - 216 RC (MD)	400Sq	550Sq	75	12.5	B S - E N - 124
MC - 216 RC (HD)	400Sq	550Sq	75	40	B S - E N - 124

Heavy Duty Grey Cast Iron Recessed Top Covers and Frames

Features:-

- Closed Keyholes
- Register
- Stainless Steel Chain
- Brass Inscription Plate Available Separately



ROYAL COMMISSION PROJECT

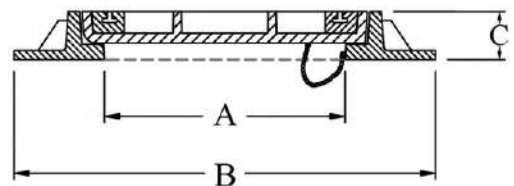
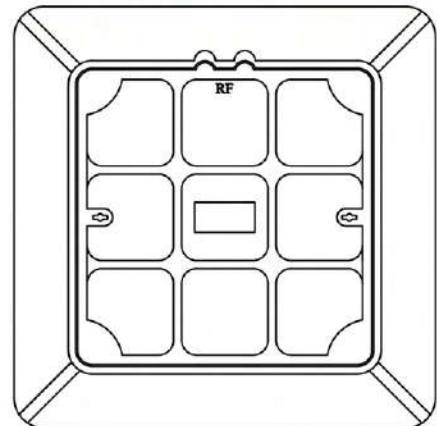

Product Code	Clear Opening A (mm)	Over Base B (mm)	Depth C (mm)	Loading (TONS)	Specifications
MC - 217 RC R3 (HD)	400Sq	700Sq	80	40	B S - E N - 124

Light Duty Grey Cast Iron Recessed Top Cover and Frames

Features:-

- Closed Keyholes
- Double Seal
- Inscription Plate Available Separately

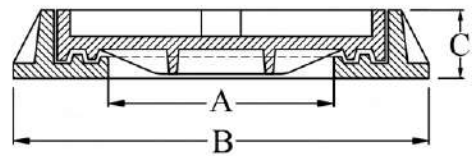
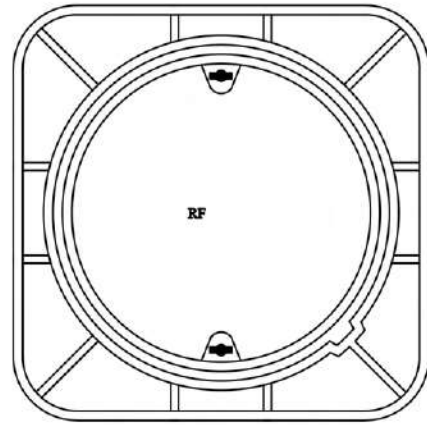

Product Code	Clear Opening A (mm)	Over Base B (mm)	Depth C (mm)	Loading (TONS)	Specifications
MC - 218 RC R1 (LD)	400Ø	520Sq	100	1.5	BS - EN - 124

Heavy Duty Double Seal Ductile Iron Recessed Top Covers and Frames

Features:-

- Threaded 16mm dia Eye Bolt Lifting Model
- Double Seal
- 12mm dia Drainholes 3 Nos at each side
- Inscription Plate Available Separately

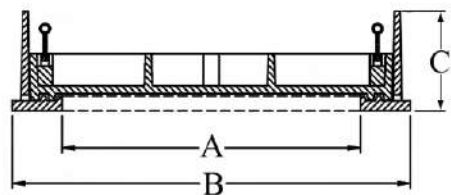
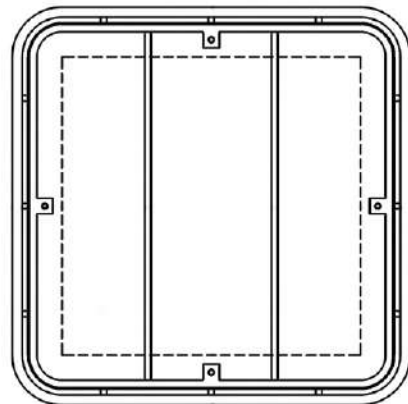

Product Code	Clear Opening A (mm)	Over Base B (mm)	Depth C (mm)	Loading (TONS)	Specifications
MC - 225 RC A DI (HD)	400Sq	600Sq	200	40	BS - EN 124

Light Medium and Heavy Duty Grey Cast Iron Recessed Top Cover and Frames

Features:-

- Register
- Closed Keyholes
- Single Seal
- Inscription Plate Available Separately

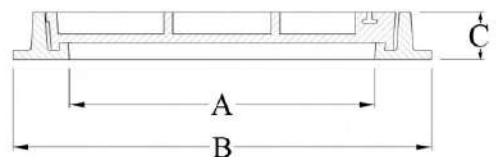
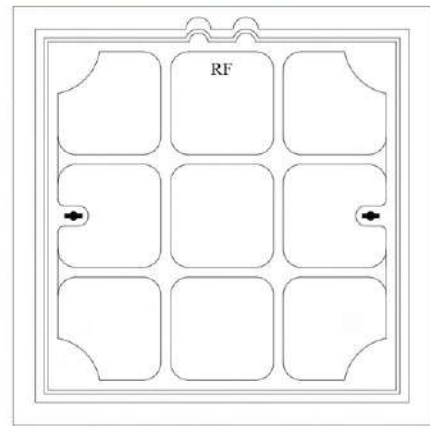

Product Code	Clear Opening A (mm)	Over Base B (mm)	Depth C (mm)	Loading (TONS)	Specifications
MC - 217 RC (LD)	500Sq	650Sq	75	1.5	B S - E N - 124
MC - 217 RC (MD)	500Sq	700Sq	75	12.5	B S - E N - 124
MC - 217 RC (HD)	500Sq	700Sq	75	40	B S - E N - 124

Light Duty Grey Cast Iron Recessed Top Cover and Frames

Features:-

- Closed Keyholes
- Double Seal
- Inscription Plate Available Separately

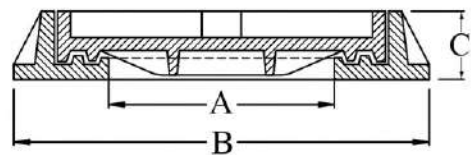
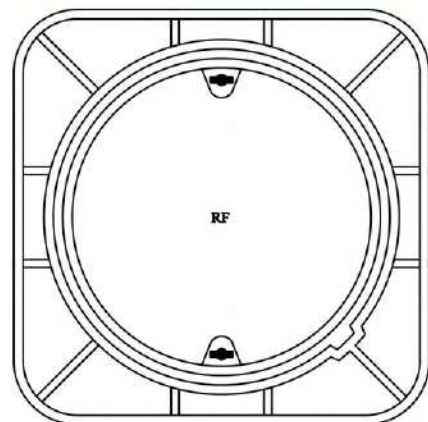

Product Code	Clear Opening A (mm)	Over Base B (mm)	Depth C (mm)	Loading (TONS)	Specifications
MC - 218 RC R2 (LD)	600Ø	750Sq	100	1.5	B S - E N - 124

Light Medium and Heavy Duty Grey Cast Iron Recessed Top Covers and Frames

Features:-

- Closed Keyholes
- Two Prising Slots
- Register
- Inscription Plate Available Separately

Option:-

- Locking Device

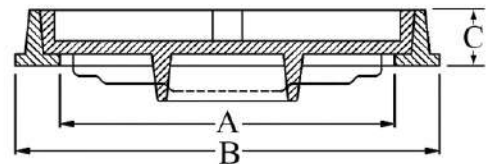
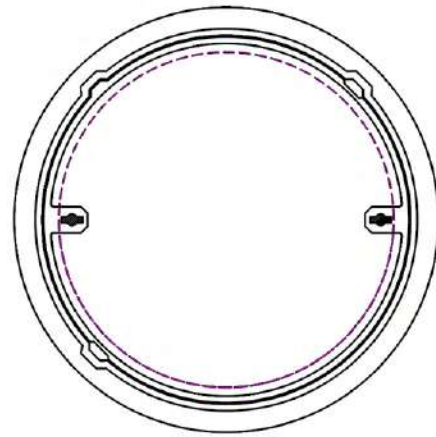

Product Code	Clear Opening A (mm)	Over Base B (mm)	Depth C (mm)	Loading (TONS)	Specifications
MC - 219 RCR (LD)	600Ø	760Ø	100	1.5	B S - E N - 124
MC - 219 RCR (MD)	600Ø	760Ø	100	12.5	B S - E N - 124
MC - 219 RCR (HD)	600Ø	760Ø	100	40	B S - E N - 124

Medium and Heavy Duty Grey Cast Iron Recessed Top Cover and Frames

Features:-

- Closed Keyholes
- 220 RC HD is Single Seal
- Inscription Plate Available Separately

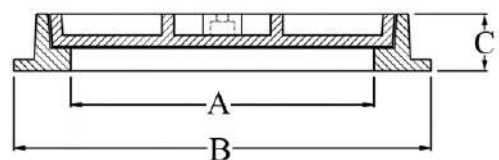
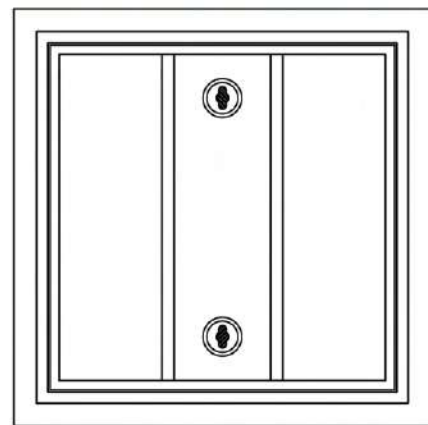

Product Code	Clear Opening A (mm)	Over Base B (mm)	Depth C (mm)	Loading (TONS)	Specifications
MC - 220 RC (MD)	600Sq	750Sq	100	12.5	B S - E N - 124
MC - 220 RC (HD)	600Sq	750Sq	100	40	B S - E N - 124

Light, Medium and Heavy Duty Grey Cast Iron Recessed Top Covers and Frames

Features:-

- Closed Keyholes
- Two Prising Slots
- Register
- Inscription Plate Available Separately

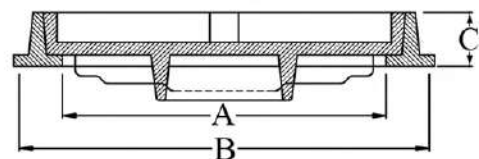
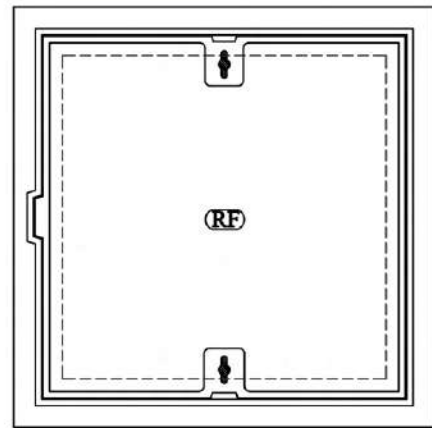

Product Code	Clear Opening A (mm)	Over Base B (mm)	Depth C (mm)	Loading (TONS)	Specifications
MC - 221 RC (LD)	600Sq	780Sq	80	1.5	BS - EN - 124
MC - 221 RC (MD)	600Sq	780Sq	80	12.5	BS - EN - 124
MC - 221 RC (HD)	600Sq	780Sq	80	40	BS - EN - 124

Light, Medium and Heavy Duty Grey Cast Iron Recessed Top Cover and Frames

Features:-

- Double Seal
- Register
- Inscription Plate Available Separately
- Combined Keyholes and Prising Slots
- Covers Secured to Frame

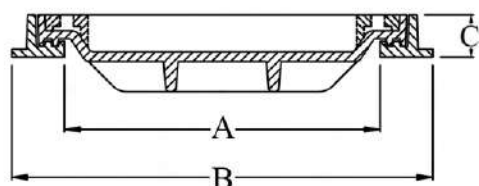
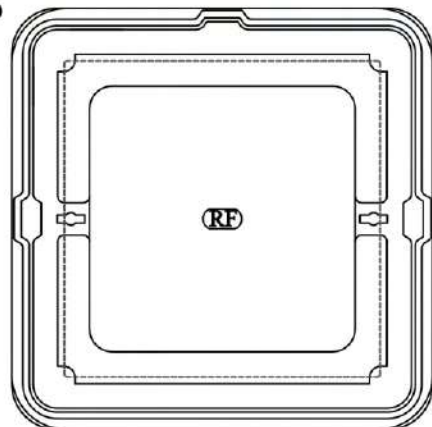

Product Code	Clear Opening A (mm)	Over Base B (mm)	Depth C (mm)	Loading (TONS)	Specifications
MC - 225 RC (LD)	600Sq	800Sq	80	1.5	BS - EN - 124
MC - 225 RC (MD)	600Sq	800Sq	80	12.5	BS - EN - 124
MC - 225 RC (HD)	600Sq	800Sq	80	40	BS - EN - 124



Heavy Duty Double Seal Ductile Iron Recessed Top Covers and Frames

Features:-

- Threaded 16mm dia Eye Bolt Lifting Model
- Double Seal
- 12mm dia Drainholes 3 Nos at each side (Option)
- Inscription Plate Available Separately

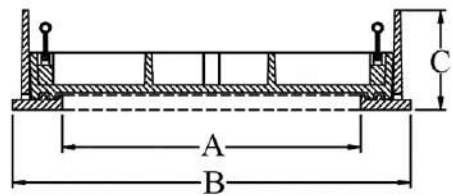
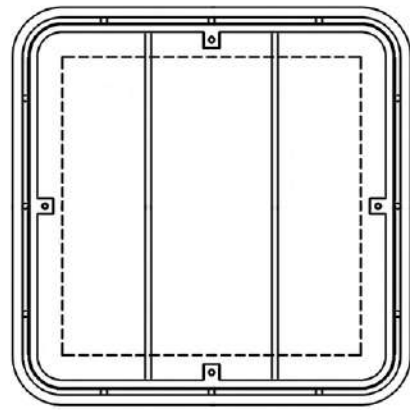

Product Code	Clear Opening A (mm)	Over Base B (mm)	Depth C (mm)	Loading (TONS)	Specifications
MC - 225 RC B DI (HD)	600Sq	800Sq	200	40	BS - EN 124

Light Medium and Heavy Duty Double Seal Ductile Iron Recessed Type Cover and Frames Cover Filled with Cement or Tiles

Features:-

- Closed Keyholes
- Double Seal
- Inscription Plate Available Separately

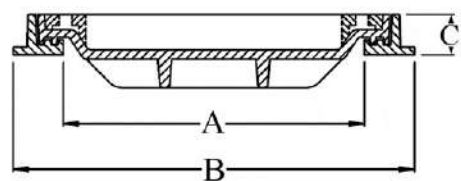
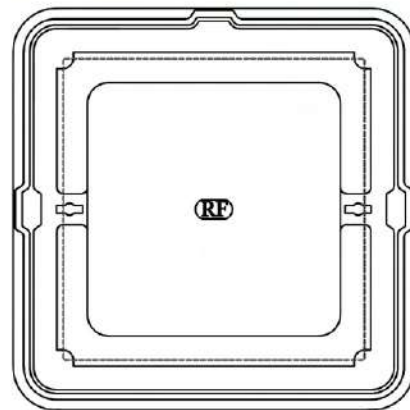

Product Code	Clear Opening A (mm)	Over Base B (mm)	Depth C (mm)	Loading (TONS)	Specifications
MC - 225 RC DI (MD)	600Sq	800Sq	80	12.5	BS - EN 124
MC - 225 RC DI (HD)	600Sq	800Sq	80	40	BS - EN 124

Medium and Heavy Duty Grey Cast Iron Recessed Top Cover and Frames

Features:-

- Closed Keyholes
- Inscription Plate Available Separately

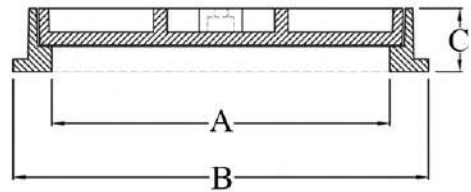
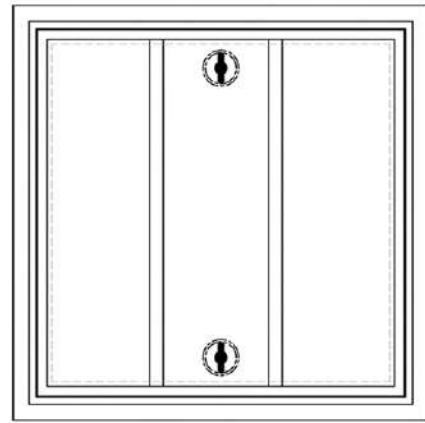

Product Code	Clear Opening A (mm)	Over Base B (mm)	Depth C (mm)	Loading (TONS)	Specifications
MC - 230 R C (MD)	700Sq	860Sq	120	12.5	B S - E N - 124
MC - 230 R C (HD)	700Sq	860Sq	120	40	B S - E N - 124

Light Duty Grey Cast Iron Recessed Top Cover and Frames

Features:-

- Closed Keyholes
- Double Seal
- Inscription Plate Available Separately

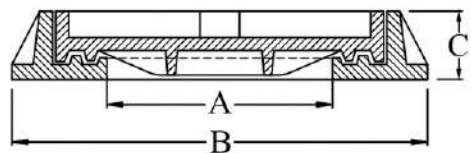
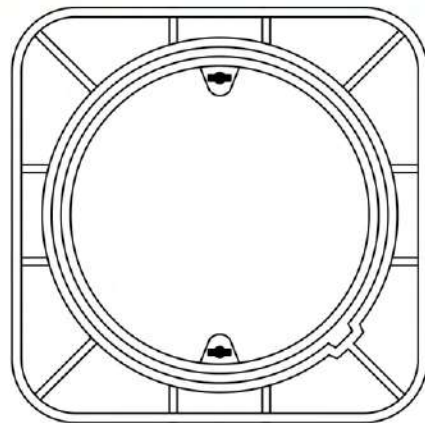

Product Code	Clear Opening A (mm)	Over Base B (mm)	Depth C (mm)	Loading (TONS)	Specifications
MC - 218 RC R3 (LD)	800Ø	960Sq	120	1.5	B S - E N - 124

Medium and Heavy Duty Grey Cast Iron Recessed Top Cover and Frames

Features:-

- Closed Keyholes
- Inscription Plate Available Separately

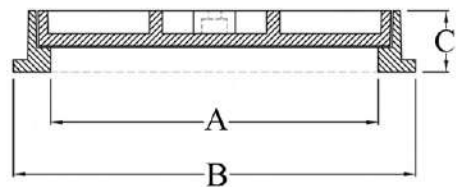
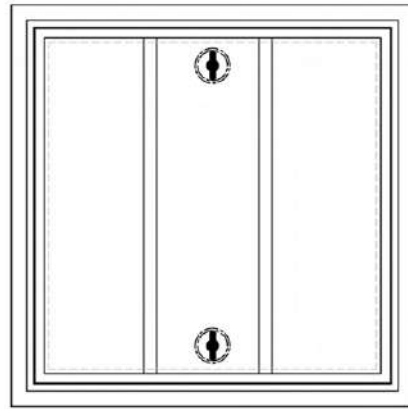

Product Code	Clear Opening A (mm)	Over Base B (mm)	Depth C (mm)	Loading (TONS)	Specifications
MC - 235 R C (MD)	800Sq	960Sq	120	12.5	B S - E N - 124
MC - 235 R C (HD)	800Sq	960Sq	120	40	B S - E N - 124

Heavy Duty Double Seal Ductile Iron Recessed Top Covers and Frames

Features:-

- Threaded 16mm dia Eye Bolt Lifting Model
- Double Seal
- 12mm dia Drainholes 3 Nos at each side
- Inscription Plate Available Separately

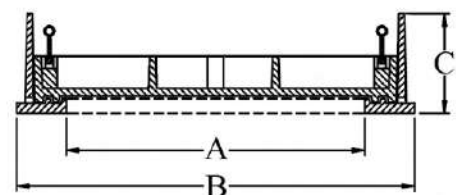
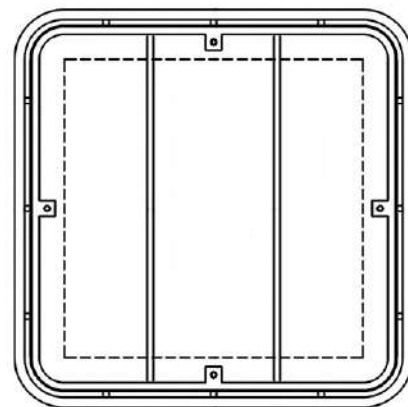

Product Code	Clear Opening A (mm)	Over Base B (mm)	Depth C (mm)	Loading (TONS)	Specifications
MC - 225 RC R DI (HD)	900Sq	1100Sq	200	40	B S - E N 124

Light Medium and Heavy Duty Grey Cast Iron Recessed Top Cover and Frames

Features:-

- Closed Keyholes
- Cover Filled Concrete Tiles
- Inscription Plate Available Separately

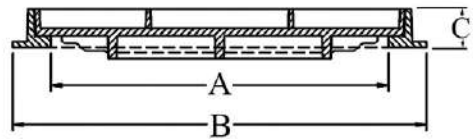
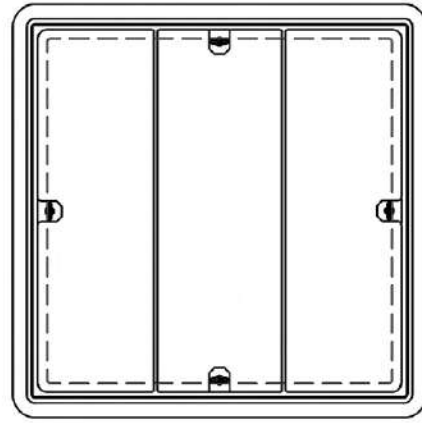

Product Code	Clear Opening A (mm)	Over Base B (mm)	Depth C (mm)	Loading (TONS)	Specifications
MC - 225 RC R3 (LD)	900Sq	1100Sq	100	1.5	B S - EN 124
MC - 225 RC R3 (MD)	900Sq	1100Sq	100	12.5	B S - EN 124
MC - 225 RC R3 (HD)	900Sq	1100Sq	100	40	B S - EN 124

Heavy Duty Double Seal Ductile Iron Recessed Top Covers and Frames

Features:-

- Threaded 16mm dia Eye Bolt Lifting Model
- Double Seal
- 12mm dia Drainholes 3 Nos at each side
- Inscription Plate Available Separately

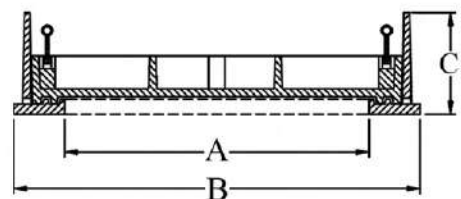
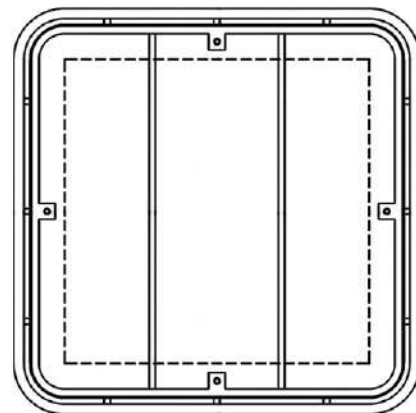

Product Code	Clear Opening A (mm)	Over Base B (mm)	Depth C (mm)	Loading (TONS)	Specifications
MC - 225 RC D DI (HD)	1000Sq	1200Sq	200	40	B S - EN 124

Multi Duty Grey Cast Iron Recessed Top Cover and Frames

Features:-

- Closed Keyholes
- Cover Filled Concrete Tiles
- Inscription Plate Available Separately

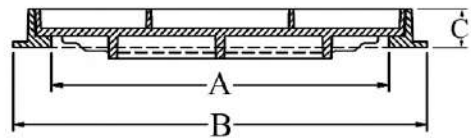
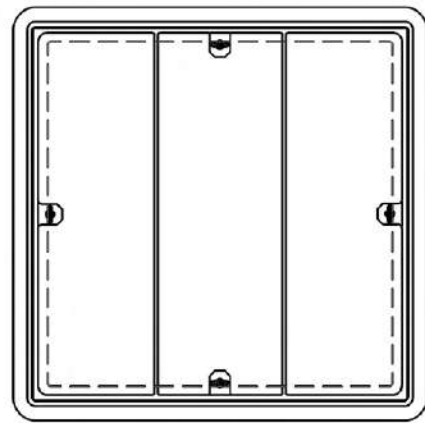

Product Code	Clear Opening A (mm)	Over Base B (mm)	Depth C (mm)	Loading (TONS)	Specifications
MC - 225 RC R4 (LD)	1000Sq	1200Sq	100	1.5	B S - EN 124
MC - 225 RC R4 (MD)	1000Sq	1200Sq	100	12.5	B S - EN 124
MC - 225 RC R4 (HD)	1000Sq	1200Sq	100	40	B S - EN 124

Medium and Heavy Duty Grey Cast Iron Recessed Top Cover and Mild Steel Angle Frame

Features:-

- Closed Keyholes
- Galvanized Steel Frame / Black epoxy Coated
- Foundation Bolt Plate
- Inscription Plate Available Separately

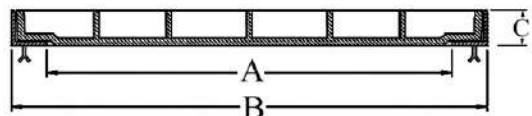
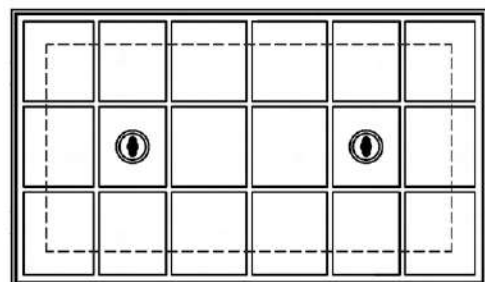

Product Code	Clear Opening A (mm)	Over Base B (mm)	Depth C (mm)	Loading (TONS)	Specifications
MC - 236 RC (MD)	500 X 1000	660 X 1160	80	12.5	B S - EN - 124
MC - 236 RC (HD)	500 X 1000	660 X 1160	80	40	B S - EN - 124

Medium and Heavy Duty Grey Cast Iron Recessed Top Covers and Frames

Features:-

- Closed Keyholes
- Single Seal
- Foundation Bolt Holes
- Inscription Plate Available Separately

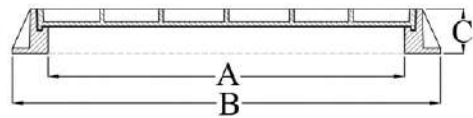
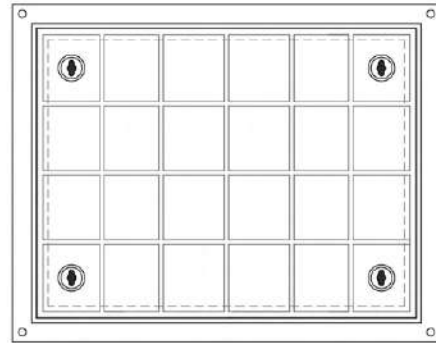

Product Code	Clear Opening A (mm)	Over Base B (mm)	Depth C (mm)	Loading (TONS)	Specifications
MC - 230 R C R 3 (MD)	700 X 1000	900 X 1200	185	12.5	BS - EN 124
MC - 230 R C R 3 (HD)	700 X 1000	900 X 1200	185	40	BS - EN 124
MC - 226 R C R (HD)	770 X 620	970 X 820	100	40	BS - EN 124

Light Medium and Heavy Duty Recessed Top Grey Cast Iron Multiple Covers and Frames

Features:-

- Four Closed Keyholes on each Cover
- Double Cover with Single Frame
- Individual Side Frame Bolted Together
- Inscription Plate Available Separately

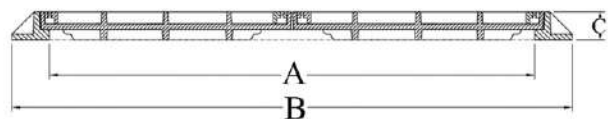
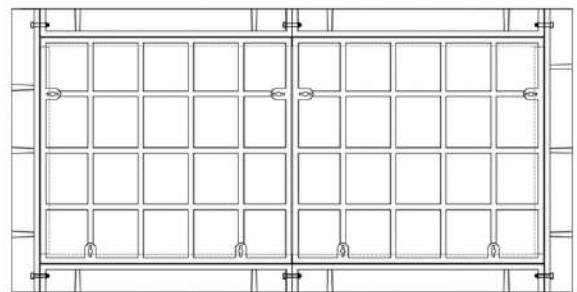

Product Code	Clear Opening A (mm)	Over Base B (mm)	Depth C (mm)	Loading (TONS)	Specifications
MC - 230 R C R 1 (LD)	750 X 1200	1020 X 1470	100	1.5	BS - EN - 124
MC - 230 R C R 1 (MD)	750 X 1200	1020 X 1470	100	12.5	BS - EN - 124
MC - 230 R C R 1 (HD)	750 X 1200	1020 X 1470	100	40	BS - EN - 124

Medium and Heavy Duty Grey Cast Iron Recessed Top Multiple Covers and Mild Steel Frames

Features:-

- Closed Keyholes
- Galvanized Steel Frame / Black epoxy Coated Frames
- Removable "T" bar

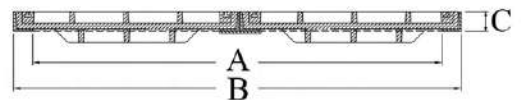
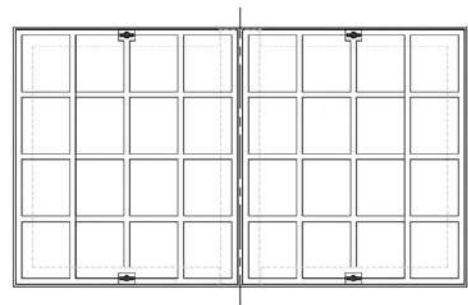

Product Code	Clear Opening A (mm)	Over Base B (mm)	Depth C (mm)	Loading (TONS)	Specifications
MC - 120 X 60 RC C2 (MD)	1200 X 600	1340 X 740	70	12.5	BS - EN - 124
MC - 120 X 60 RC C2 (HD)	1200 X 600	1340 X 740	70	40	BS - EN - 124

Medium Duty Grey Cast Iron Recessed Multiple Covers and Mild Steel Frames

Features:-

- Closed Keyholes
- Beam Housing Box
- Removable "T" bar and "I" Beam
- Black epoxy Coated Frame

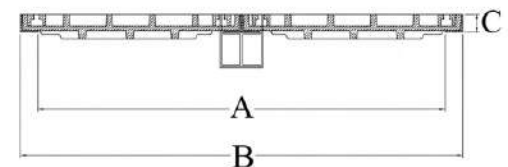
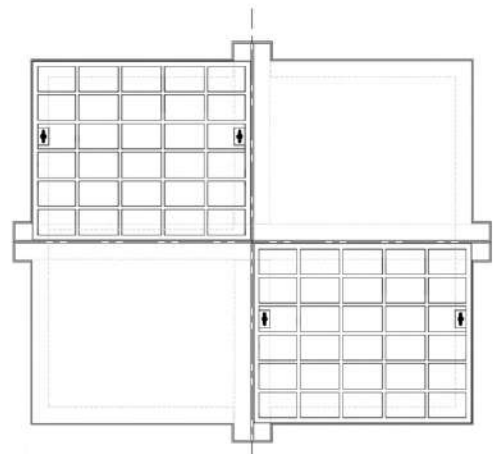

Product Code	Clear Opening A (mm)	Over Base B (mm)	Depth C (mm)	Loading (TONS)	Specifications
MC - 120 X 120 RC (MD)	1200 X 1200	1340 X 1340	70	12.5	BS - EN - 124

Medium and Heavy Duty Grey Cast Iron Recessed Top Multiple Covers and Mild Steel Frames

Features:-

- Closed Keyholes
- Galvanized Steel Frame / Black epoxy Coated Frames
- Removable "T" bar

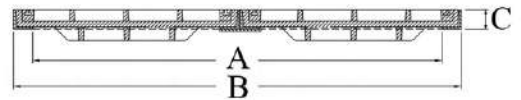
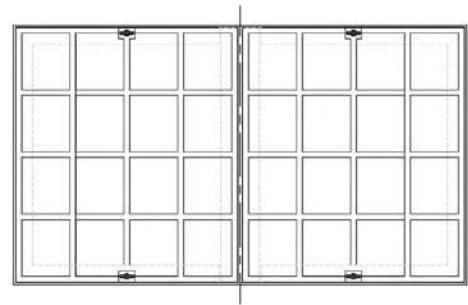

Product Code	Clear Opening A (mm)	Over Base B (mm)	Depth C (mm)	Loading (TONS)	Specifications
MC - 150 X 80 RC C2 (MD)	1500 X 800	1640 X 940	70	12.5	BS - EN - 124
MC - 150 X 80 RC C2 (HD)	1500 X 800	1640 X 940	70	40	BS - EN - 124

Medium and Heavy Duty Grey Cast Iron Recessed Multiple Covers and Mild Steel Frames

Features:-

- Closed Keyholes
- Beam Housing Box
- Removable "T" bar and "I" Beam
- Black epoxy Coated Frame

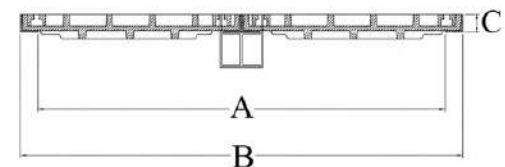
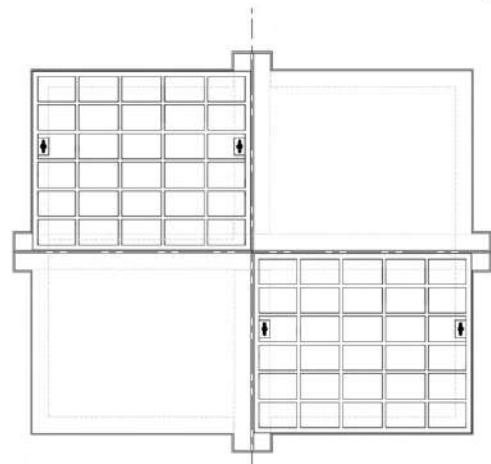

Product Code	Clear Opening A (mm)	Over Base B (mm)	Depth C (mm)	Loading (TONS)	Specifications
MC - 150 X 120 RC (MD)	1500 X 1200	1640 X 1340	70	12.5	BS - EN - 124
MC - 150 X 120 RC (HD)	1500 X 1200	1660 X 1360	80	40	BS - EN - 124



Medium and Heavy Duty Recessed Top Grey Cast Iron Multiple Covers and Frames

Features:-

- Four Closed Keyholes on each Cover
- Double Cover with Single Frame
- Individual Side Frame Bolted Together
- Inscription Plate Available Separately

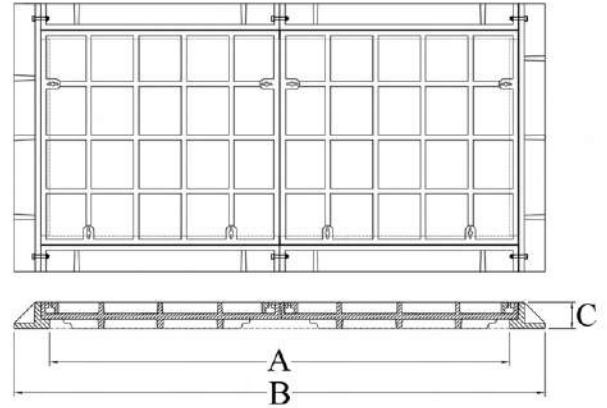

Product Code	Clear Opening A (mm)	Over Base B (mm)	Depth C (mm)	Loading (TONS)	Specifications
MC - 231 R C R2 (MD)	1600 X 800	1800 X 1000	100	12.5	B S - E N - 124
MC - 231 R C R2 (HD)	1600 X 800	1800 X 1000	100	40	B S - E N - 124

Medium and Heavy Duty Grey Cast Iron Recessed Top Multiple Covers and Mild Steel Frames

Features:-

- Closed Keyholes
- Galvanized Steel Frame / Black epoxy Coated Frames
- Removable "T" bar

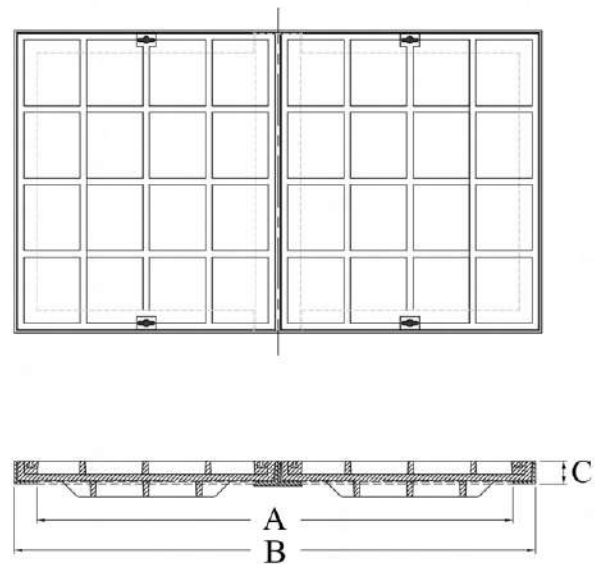

Product Code	Clear Opening A (mm)	Over Base B (mm)	Depth C (mm)	Loading (TONS)	Specifications
MC - 160 X 80 RC C2 (MD)	1600 X 800	1740 X 940	70	12.5	B S - E N - 124
MC - 160 X 80 RC C2 (HD)	1600 X 600	1740 X 940	70	40	B S - E N - 124

Medium and Heavy Duty Recessed Top Grey Cast Iron Multiple Covers and Frames

Features:-

- Four Closed Keyholes on each Cover
- Double Cover with Single Frame
- Individual Side Frame Bolted Together
- Inscription Plate Available Separately

MC - 230 RC R M2 (MD) FOR ROYAL COMMISSION PROJECT

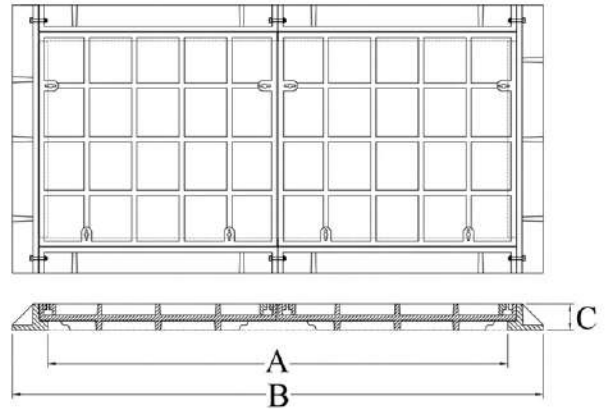

Product Code	Clear Opening A (mm)	Over Base B (mm)	Depth C (mm)	Loading (TONS)	Specifications
MC - 230 R C R4 M (MD)	1750 X 750	1950 X 950	100	12.5	BS - EN - 124
MC - 230 R C R4 M (HD)	1750 X 750	1950 X 950	100	40	BS - EN - 124
MC - 230 R C R M2 (MD)	1750 X 750	2020 X 1020	100	12.5	BS - EN - 124

MULTIPLE COVERS AND FRAMES - (RECESSED TOP)

GREY CAST IRON

Medium and Heavy Duty Grey Cast Iron Recessed Top Multiple Covers and Frames

Features:-

- Closed Keyholes
- Inscription Plate Available Separately
- Single Seal

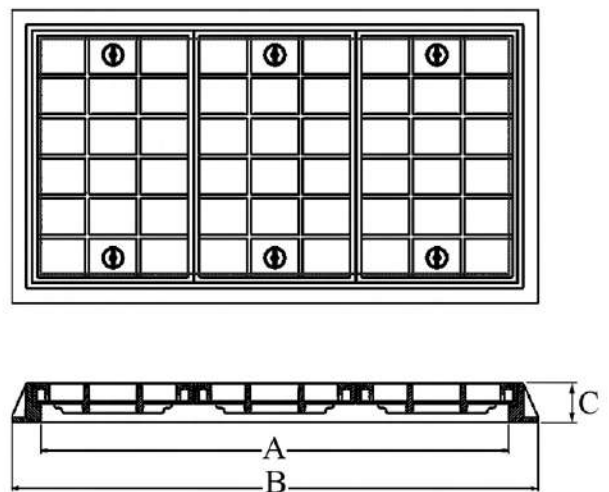

Product Code	Clear Opening A (mm)	Over Base B (mm)	Depth C (mm)	Loading (TONS)	Specifications
MC - 237 R C3 (MD)	1800 X 900	2025 X 1125	100	12.5	BS - EN - 124
MC - 237 R C3 (HD)	1800 X 900	2025 X 1125	150	40	BS - EN - 124



Heavy Duty Grey Cast Iron Recessed Multiple Covers and Mild Steel Frames

Features:-

- Closed Keyholes
- Beam Housing Box
- Removable "T" bar and "I" Beam
- Black epoxy Coated Frame

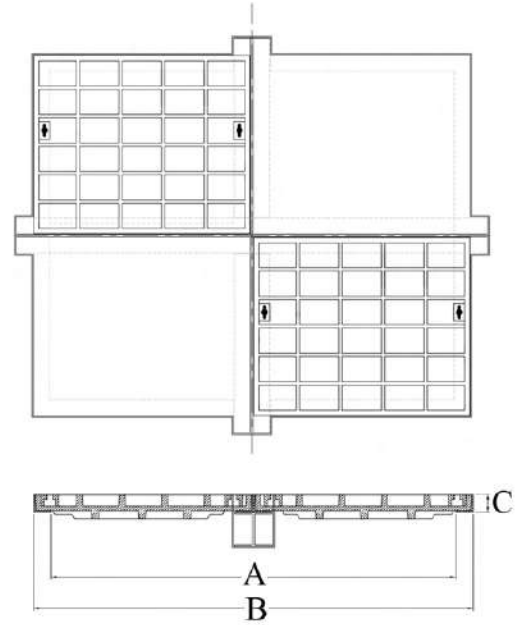

Product Code	Clear Opening A (mm)	Over Base B (mm)	Depth C (mm)	Loading (TONS)	Specifications
MC - 185 X 150 RC (HD)	1850 X 1500	2010 X 1660	80	40	B S - E N - 124

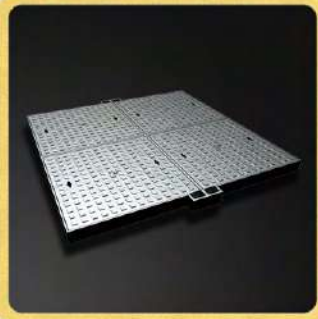
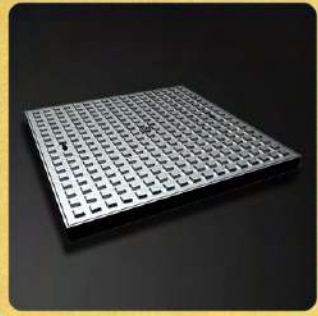
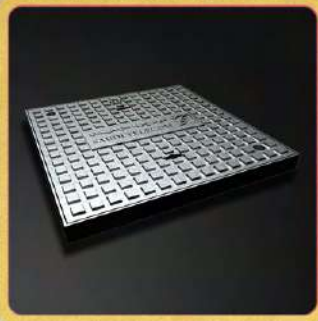

COVERS WITH MILD STEEL ANGLE FRAMES

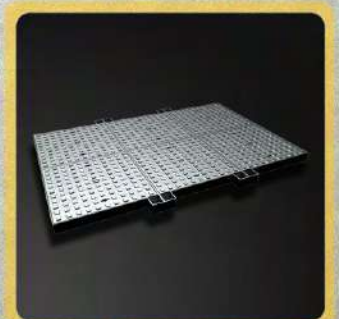
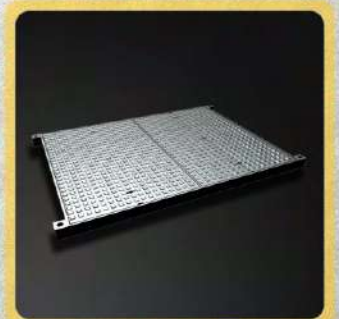

Light Duty Grey Cast Iron Covers with Mild Steel Angle Frames

Features:-

- Closed Keyholes
- Hot Dip Galvanized Mild Steel Frame / Black epoxy Coated Frame

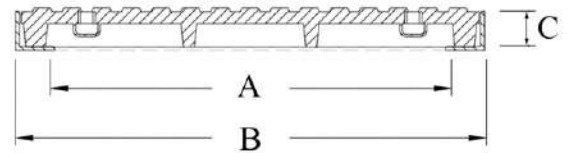
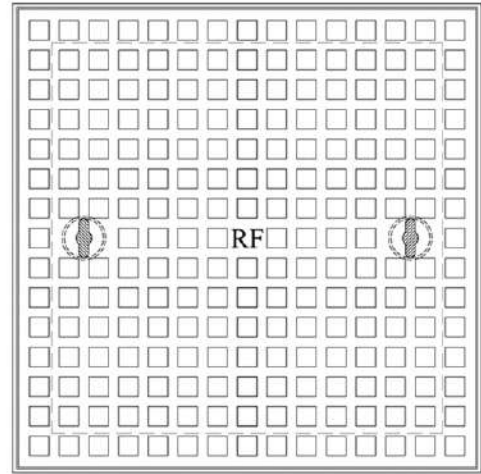

Product Code	Clear Opening A (mm)	Over Base B (mm)	Depth C (mm)	Loading (TONS)	Specifications
MC - 50 X 50 C1 (LD)	500Sq	600Sq	50	1.5	BS - EN - 124

Light Duty Grey Cast Iron Covers with Mild Steel Angle Frames

Features:-

- Closed Keyholes
- Galvanized Frame / Black epoxy Coated Frame

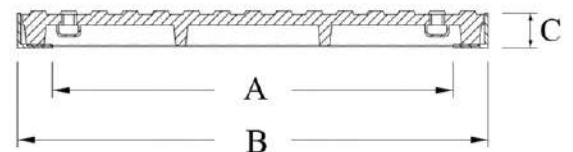
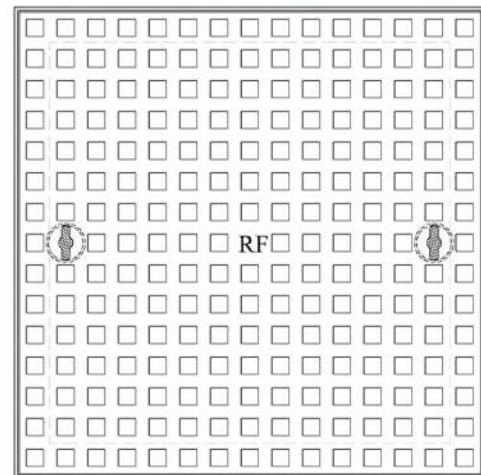

Product Code	Cover Size A (mm)	Clear Opening A (mm)	Over Base B (mm)	Depth C (mm)	Loading (TONS)	Specifications
MC - 66 X 66 C1 (LD)	660Sq	575Sq	675Sq	50	1.5	BS - EN - 124

Light Duty Grey Cast Iron Covers with Mild Steel Angle Frames

Features:-

- Closed Keyholes
- Hot Dip Galvanized Mild Steel Frame / Black epoxy Coated Frame

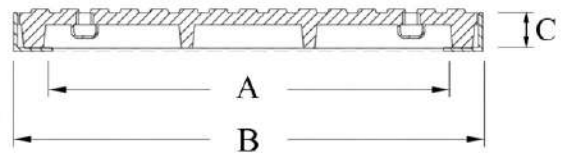
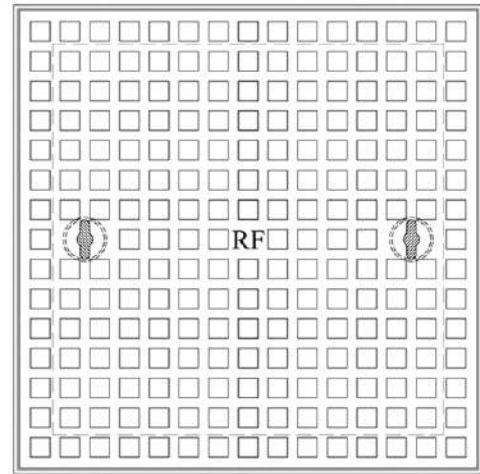

Product Code	Clear Opening A (mm)	Over Base B (mm)	Depth C (mm)	Loading (TONS)	Specifications
MC - 60 X 60 C1 (LD)	600Sq	700Sq	50	1.5	BS - EN - 124

Heavy Duty Grey Cast Iron Multiple Covers with Mild Steel Angle Frames

Features:-

- Two Closed Keyholes for each Cover
- Two Prising Slots for each Cover
- Steel Frame Provided with Anchor clits Welded at intervals for Fixing Purpose
- Stop End Frames Available
- Angle Frame 50 X 50 X 5mm

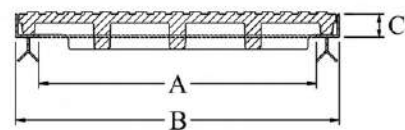
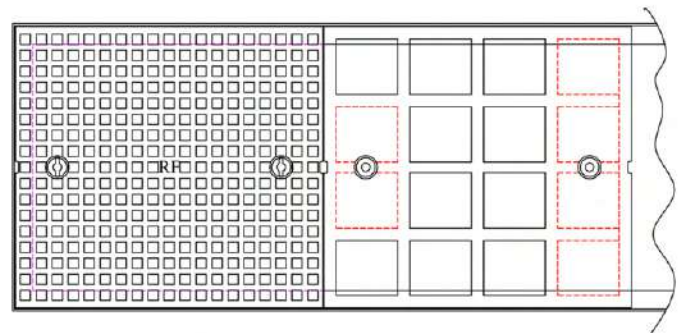

Product Code	Clear Opening A (mm) width	Over Base B (mm) width	Depth C (mm)	Loading (TONS)	Specifications
MC - 60 X 70 A - 40 (HD)	600Sq	700Sq	50	40	BS - EN - 124

Heavy Duty Grey Cast Iron Covers with Mild Steel Angle Frames

Features:-

- Closed Keyholes
- Galvanized Frame / Black epoxy Coated Frame

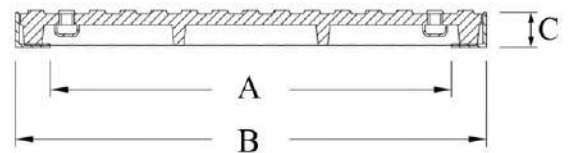
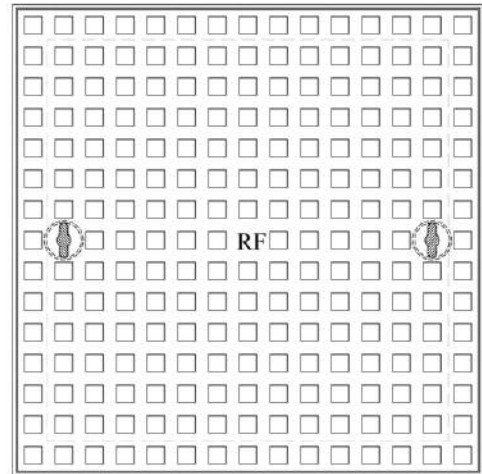

Product Code	Cover Size A (mm)	Clear Opening A (mm)	Over Base B (mm)	Depth C (mm)	Loading (TONS)	Specifications
MC - 70 X 70 C1 (HD)	700Sq	615Sq	715Sq	50	40	B S - E N - 124

Light Duty Grey Cast Iron Covers with Mild Steel Angle Frames

Features:-

- Closed Keyholes
- Hot Dip Galvanized Mild Steel Frame / Black epoxy Coated Frame

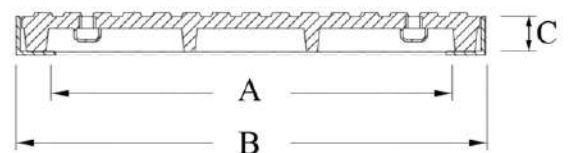
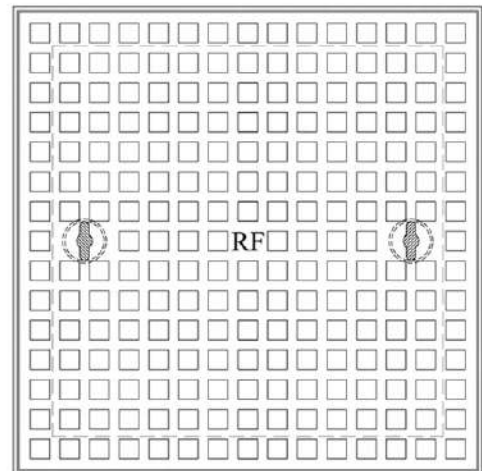

Product Code	Clear Opening A (mm)	Over Base B (mm)	Depth C (mm)	Loading (TONS)	Specifications
MC - 70 X 70 C1 (LD)	700Sq	800Sq	50	1.5	B S - E N - 124

Light Duty Grey Cast Iron Covers with Mild Steel Angle Frames

Features:-

- Closed Keyholes
- Hot Dip Galvanized Mild Steel Frame / Black epoxy Coated Frame

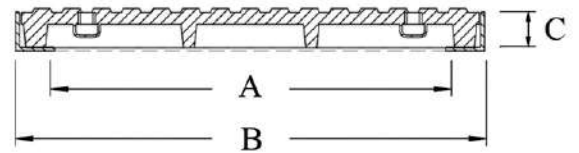
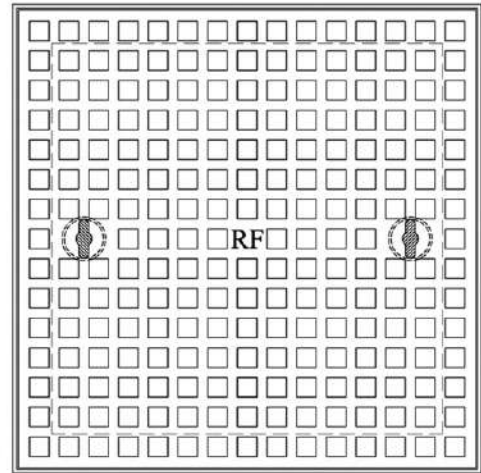

Product Code	Clear Opening A (mm)	Over Base B (mm)	Depth C (mm)	Loading (TONS)	Specifications
MC - 75 X 75 C1 (LD)	800Sq	900Sq	50	1.5	BS - EN - 124
MC - 90 X 75 C1 (LD)	900Sq	1000Sq	50	1.5	BS - EN - 124

Heavy Duty Grey Cast Iron Multiple Covers with Mild Steel Angle Frames

Features:-

- Four Closed Keyholes for each Cover
- Two Prising Slots for each Cover
- Steel Frame Provided With Fish - Tail Legs Welded at Intervals for Fixing Purpose
- Angle Frame 50 X 50 X 5mm
- For Airport Inside the Hangar 60Tons With 80 X 80 X 8 mm Angle frame will be used

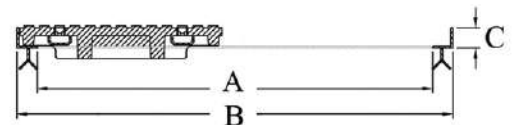
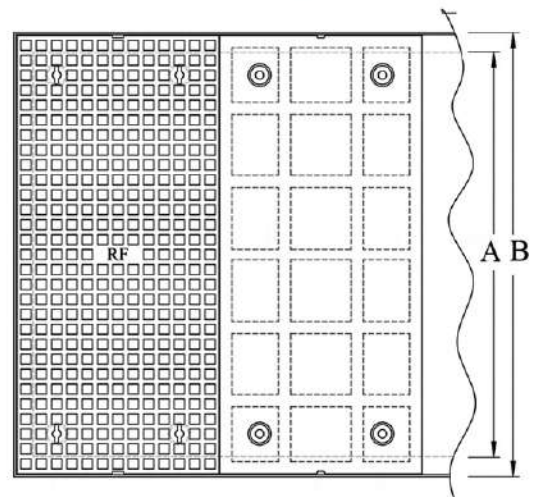
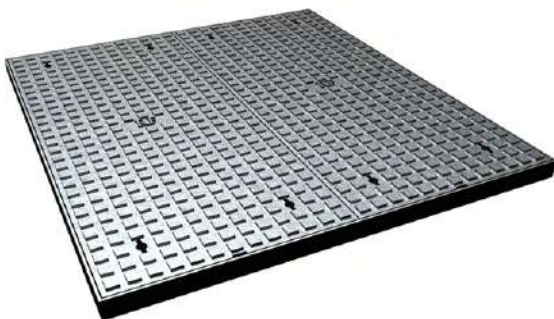

Product Code	Clear Opening A (mm) width	Over Base B (mm) width	Depth C (mm)	Loading (TONS)	Specifications
MC - 100 X 110 A - 40 (HD)	1000Sq	1100Sq	50	40	BS - EN - 124

Heavy Duty Grey Cast Iron Multiple Covers with Mild steel Angle Frame

Features:-

- Closed Keyholes
- Galvanized Steel Frame
- Removable "T" bar and "I" beam
- Beam Housing Box

Options:-

- Black epoxy Coated Frame

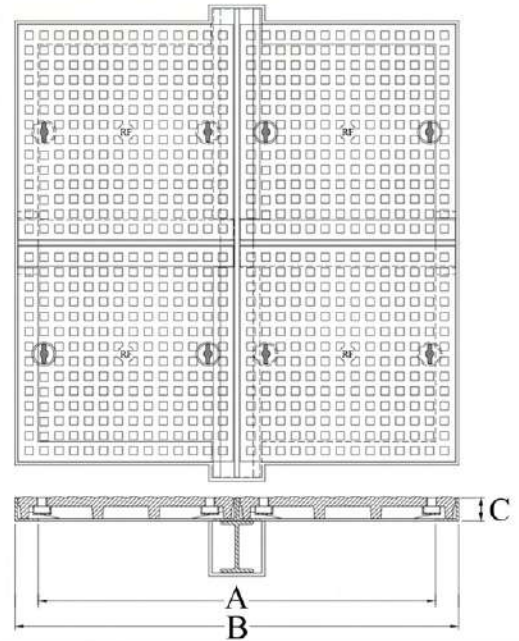

Product Code	Clear Opening A (mm)	Over Base B (mm)	Depth C (mm)	Loading (TONS)	Specifications
MC - 106 X 106 C4 2 X 2 (HD)	1060Sq	1200Sq	70	25	B S - E N - 124
MC - 120 X 120 C4 2 X 2 (HD)	1200Sq	1340Sq	70	35	B S - E N - 124
MC - 130 X 130 C4 2 X 2 (HD)	1300Sq	1440Sq	70	40	B S - E N - 124
MC - 136 X 136 C4 2 X 2 (HD)	1360Sq	1500Sq	70	40	B S - E N - 124
MC - 140 X 140 C4 2 X 2 (HD)	1400Sq	1540Sq	70	40	B S - E N - 124
MC - 150 X 150 C4 2 X 2 (HD)	1500Sq	1640Sq	70	40	B S - E N - 124

Heavy Duty Grey Cast Iron Multiple Covers with Mild Steel Angle Frames

Features:-

- Closed Keyholes
- Black epoxy Coated Frame
- Removable "T" bar and "I" beam
- Beam Housing Box
- For Slow Moving Traffic Only
- Not Used For High Ways
- Light Vehicle Access Only

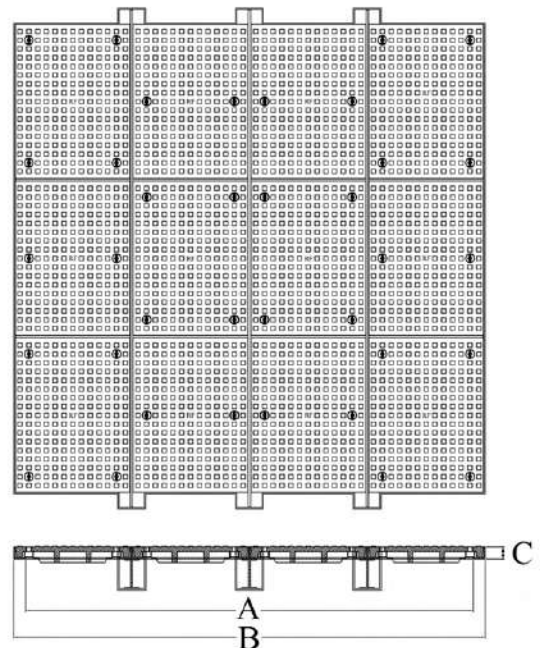

Product Code	Clear Opening A (mm)	Over Base B (mm)	Depth C (mm)	Loading (TONS)	Specifications
MC - 250 X 250 C12 3 X 4 (HD)	2500Sq	2660Sq	80	35	B S - E N 124
MC - 300 X 300 C12 3 X 4 (HD)	3000Sq	3160Sq	80	35	B S - E N 124



Light Duty Grey Cast Iron Covers with Mild Steel Angle Frames

Features:-

- Closed Keyholes
- Hot Dip Galvanized Mild Steel Frame / Black epoxy Coated Frame

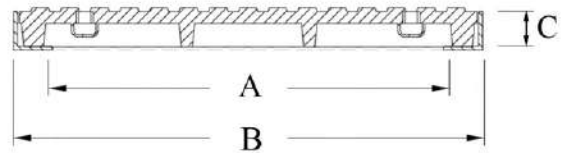
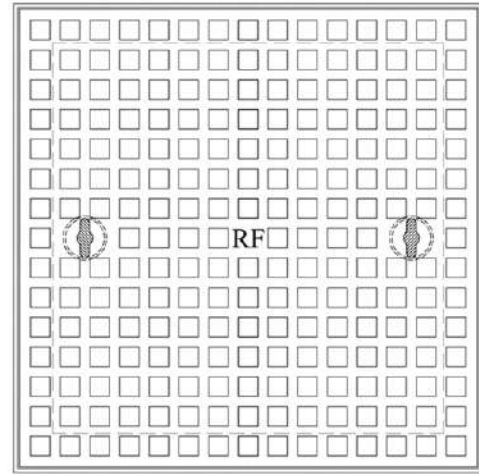

Product Code	Clear Opening A (mm)	Over Base B (mm)	Depth C (mm)	Loading (TONS)	Specifications
MC - 60 X 75 C1 (LD)	600 X 750	700 X 850	50	1.5	BS - EN - 124

Light Medium and Heavy Duty Grey Cast Iron Multiple Covers with Mild Steel Angle Frames

Features:-

- Closed Keyholes
- Galvanized Steel Frame
- Removable "T" bar
- Four Holes for Anchoring

Options:-

- Black epoxy Paint

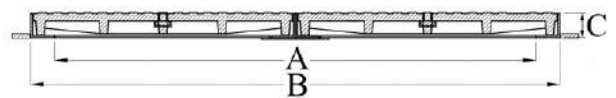
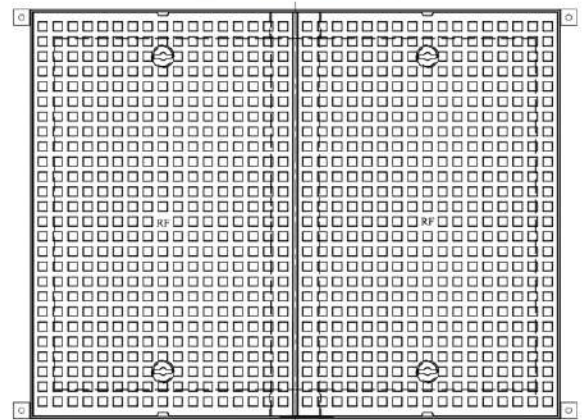

Product Code	Clear Opening A (mm)	Over Base B (mm)	Depth C (mm)	Loading (TONS)	Specifications
MC - 360 C2 (LD)	1146 X 900	1306 X 1060	80	1.5	BS - EN - 124
MC - 360 C2 (MD)	1146 X 900	1306 X 1060	80	12.5	BS - EN - 124
MC - 360 C2 (HD)	1146 X 900	1306 X 1060	80	40	BS - EN - 124
MC - 76 X 115 C2 (HD)	760 X 1150	900 X 1290	70	40	BS - EN - 124
MC - 100 X 120 C2 (HD)	1000 X 1200	1140 X 1340	70	40	BS - EN - 124



Heavy Duty Grey Cast Iron Multiple Covers with Mild steel Angle Frame

Features:-

- Closed Keyholes
- Galvanized Steel Frame
- Removable "T" bar and "I" beam
- Beam Housing Box

Options:-

- Black epoxy Coated Frame

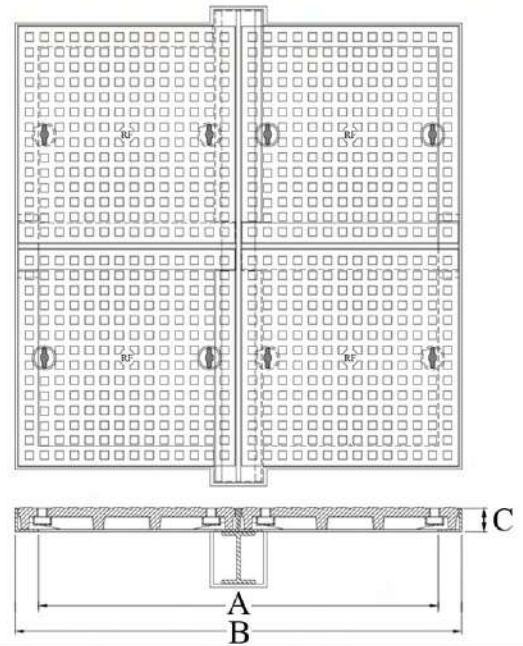

Product Code	Clear Opening A (mm)	Over Base B (mm)	Depth C (mm)	Loading (TONS)	Specifications
MC - 120 X 100 C4 2 X 2 (HD)	1200 X 1000	1340 X 1140	70	40	BS - EN - 124
MC - 361 C4 2 X 2 (HD)	1200 X 1150	1340 X 1290	70	40	BS - EN - 124
MC - 123 X 108 C4 2 X 2 (HD)	1230 X 1080	1370 X 1220	70	40	BS - EN - 124
MC - 130 X 105 C4 2 X 2 (HD)	1300 X 1050	1440 X 1190	70	40	BS - EN - 124
MC - 130 X 120 C4 (HD)	1300 X 1200	1600 X 1500	150	40	BS - EN - 124
MC - 140 X 100 C4 2 X 2 (HD)	1400 X 1000	1540 X 1140	70	40	BS - EN - 124

Heavy Duty Grey Cast Iron Multiple Covers with Hot Dip Galvanized Mild Steel Angle Frames

Features:-

- Closed Keyholes
- Single Seal
- Hot Dip Galvanized Frame
- Inner Cover
- Angle Frame Used 75 X 50mm

Options:-

- Black epoxy Coated Frame



ROYAL COMMISSION PROJECT

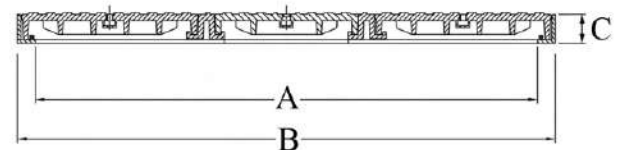
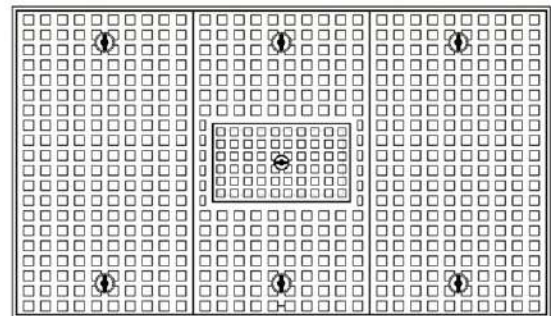

Product Code	Clear Opening A (mm)	Over Base B (mm)	Depth C (mm)	Loading (TONS)	Specifications
MC - 354 C3 (HD)	1400 X 770	1500 X 870	75	40	BS - EN - 124



Heavy Duty Grey Cast Iron Multiple Covers with Mild Steel Angle Frames

Features:-

- Closed Keyholes
- Galvanized Steel Frame
- Removable "T" bar
- Four Holes for Anchoring

Options:-

- Black epoxy Paint

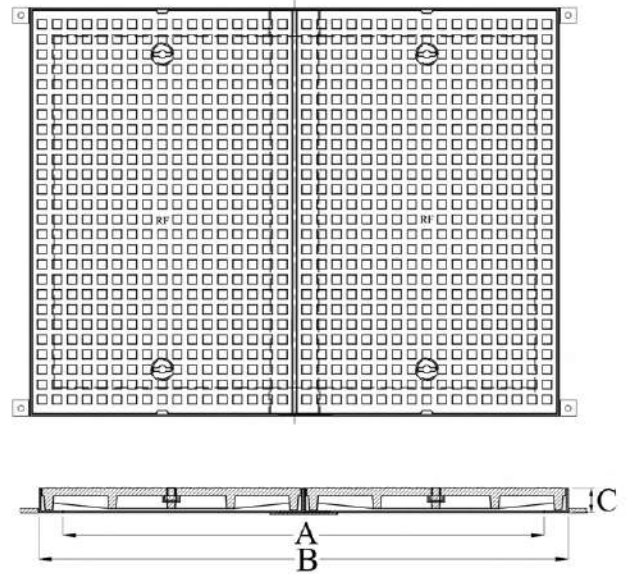

Product Code	Clear Opening A (mm)	Over Base B (mm)	Depth C (mm)	Loading (TONS)	Specifications
MC - 140 X 80 C2 (HD)	1400 X 800	1560 X 960	80	40	BS - EN - 124

Heavy Duty Grey Cast Iron Multiple Covers with Mild steel Angle Frame

Features:-

- Closed Keyholes
- Galvanized Steel Frame
- Removable "T" bar and "I" beam
- Beam Housing Box

Options:-

- Black epoxy Coated Frame

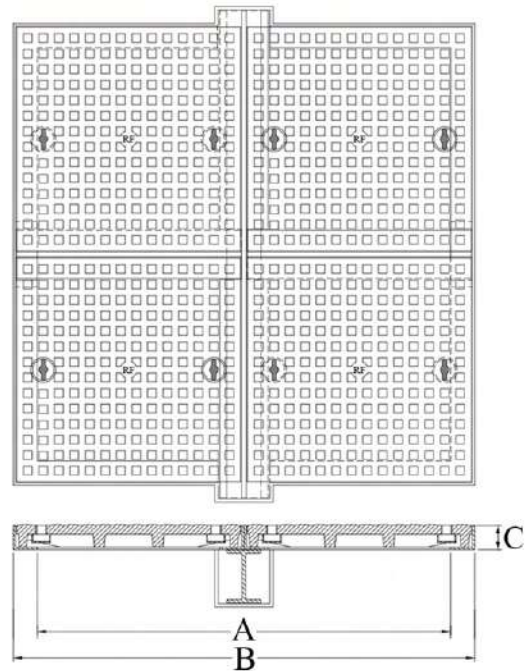

Product Code	Clear Opening A (mm)	Over Base B (mm)	Depth C (mm)	Loading (TONS)	Specifications
MC - 150 X 120 C4 2 X 2 (HD)	1500 X 1200	1640 X 1340	70	40	BS - EN - 124
MC - 160 X 110 C4 2 X 2 (HD)	1600 X 1100	1740 X 1240	70	12.5	BS - EN - 124
MC - 160 X 120 C4 2 X 2 (HD)	1600 X 1200	1740 X 1340	70	40	BS - EN - 124
MC - 160 X 172 C4 2 X 2 (HD)	1600 X 1720	1760 X 1880	80	40	BS - EN - 124

Heavy Duty Grey Cast Iron Multiple Covers with Mild Steel Angle Frames

Features:-

- Closed Keyholes
- Angle Frame 100 X 100 X 7mm
- Removable "T" bar
- Hot Dip Galvanized Frame / Black epoxy Coated Frame

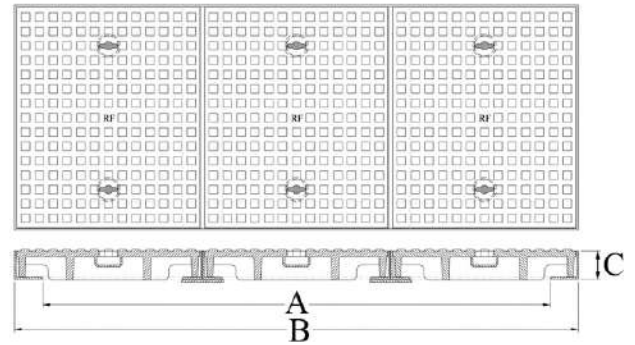

Product Code	Clear Opening A (mm)	Over Base B (mm)	Depth C (mm)	Loading (TONS)	Specifications
MC - 180 X 60 C3 / 100 (HD)	1800 X 600	2000 X 800	100	40	BS - EN - 124

Medium and Heavy Duty Grey Cast Iron Multiple Covers with Mild Steel Angle Frames

Features:-

- Closed Keyholes
- Prising Slots
- Removable "T" bar
- Holes for Anchoring
- Black Epoxy Coated MS Angle Frame

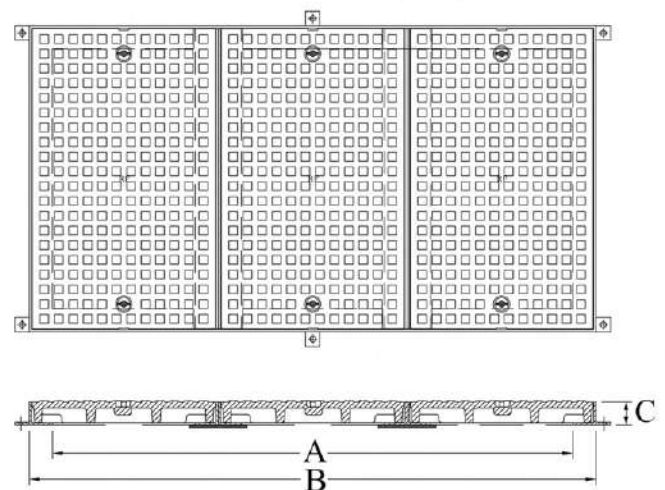

Product Code	Clear Opening A (mm)	Over Base B (mm)	Depth C (mm)	Loading (TONS)	Specifications
MC - 360 C3 (HD)	1800 X 900	1960 X 1060	80	40	BS - EN - 124
MC - 360 C3 (MD)	1800 X 900	1960 X 1060	80	12.5	BS - EN - 124



Heavy Duty Grey Cast Iron Multiple Covers with Mild Steel Angle Frames

Features:-

- Closed Keyholes
- Black epoxy Coated Frame
- Removable "T" bar and "I" beam
- Beam Housing Box
- For Slow Moving Traffic Only
- Not Used For High Ways
- Light Vehicle Access Only

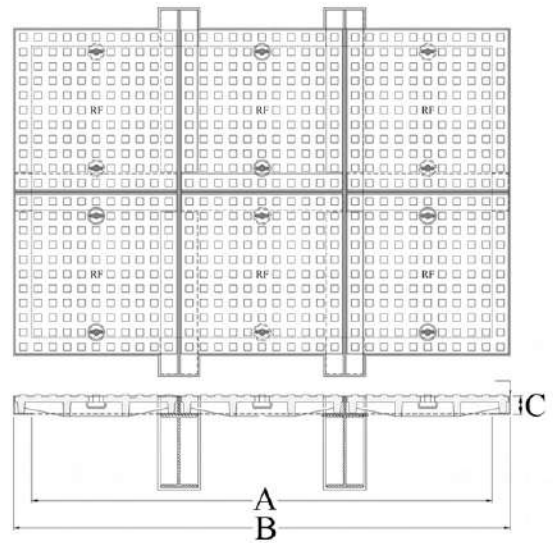

Product Code	Clear Opening A (mm)	B (mm)	Depth C (mm)	Loading (TONS)	Specifications
MC - 190 X 164 C6 2 X 3 (HD)	1900 X 1640	2040 X 1780	70	40	BS - EN

Heavy Duty Grey Cast Iron Multiple Covers with Mild Steel Angle Frames

Features:-

- Closed Keyholes
- Galvanized Steel Frame
- Removable "T" bar and "I" beam
- Beam Housing Box

Options:-

- Black epoxy Coated Frame

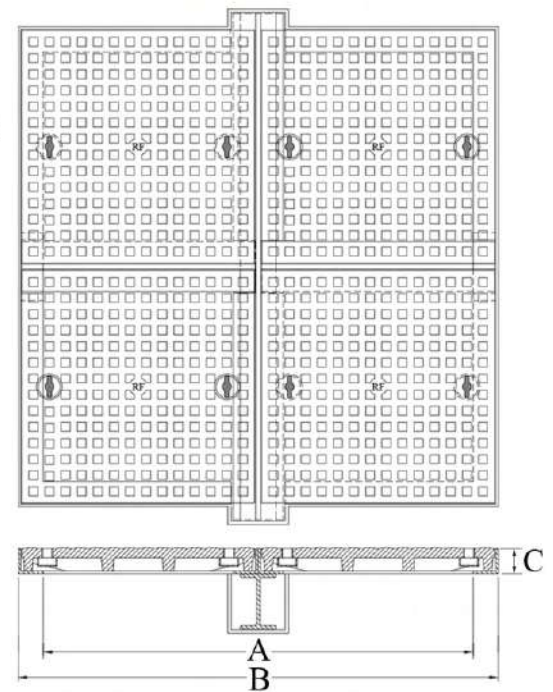

Product Code	Clear Opening A (mm)	Over Base B (mm)	Depth C (mm)	Loading (TONS)	Specifications
MC - 200 X 160 C4 2 X 2 (HD)	2000 X 1600	2160 X 1760	80	40	BS - EN - 124

Heavy Duty Grey Cast Iron Multiple Covers with Mild Steel Angle Frames

Features:-

- Closed Keyholes
- Black epoxy Coated Frame
- Removable "T" bar and "I" beam
- Beam Housing Box
- For Slow Moving Traffic Only
- Not Used For Highways
- Light Vehicle Access Only

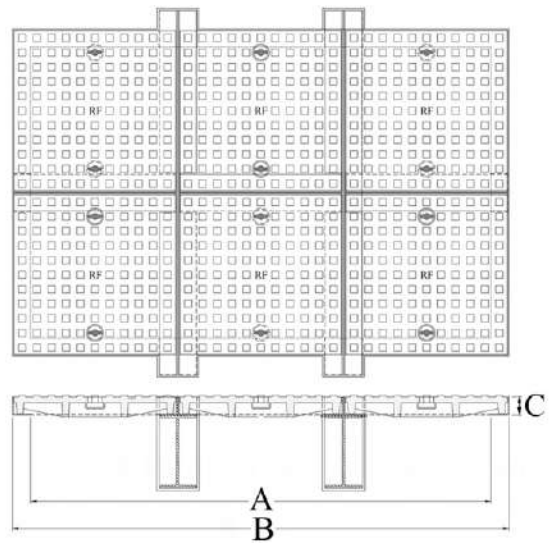

Product Code	Clear Opening A (mm)	B (mm)	Depth C (mm)	Loading (TONS)	Specifications
MC - 200 X 90 C6 2 X 3 (HD)	2000 X 900	2160 X 1060	80	40	BS - EN 124

Heavy Duty Grey Cast Iron Multiple Covers with Mild Steel Angle Frames

Features:-

- Closed Keyholes
- Black epoxy Coated Frame
- Removable "T" bar and "I" beam
- Beam Housing Box
- For Slow Moving Traffic Only
- Not Used For Highways
- Light Vehicle Access Only

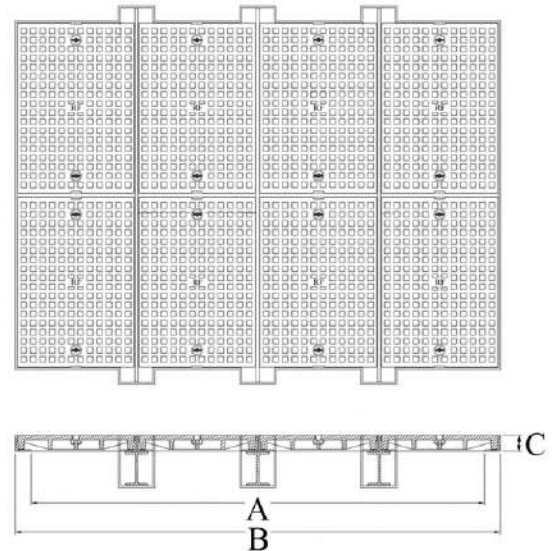

Product Code	Clear Opening A (mm)	Over Base B (mm)	Depth C (mm)	Loading (TONS)	Specifications
MC - 200 X 120 C8 2 X 4 (HD)	2000 X 1200	2140 X 1340	70	35	BS - EN 124
MC - 200 X 140 C8 2 X 4 (HD)	2000 X 1400	2140 X 1540	70	35	BS - EN 124
MC - 245 X 120 C8 2 X 4 (HD)	2450 X 1200	2610 X 1360	80	35	BS - EN 124



Heavy Duty Grey Cast Iron Multiple Covers with Mild Steel Angle Frames

Features:-

- Closed Keyholes
- Black epoxy Coated Frame
- Removable "T" bar and "I" beam
- Beam Housing Box
- For Slow Moving Traffic Only
- Not Used For High Ways
- Light Vehicle Access Only

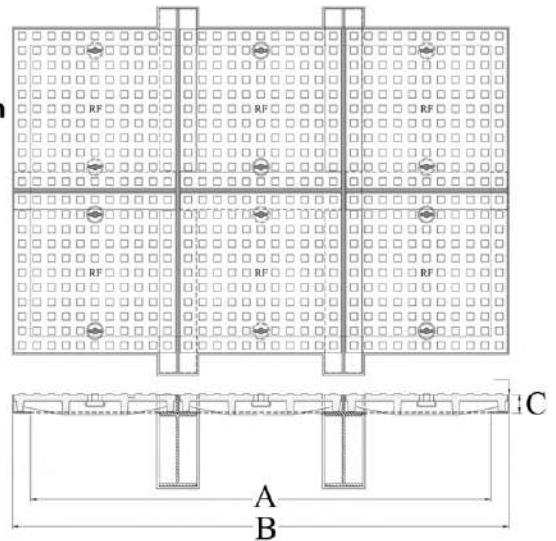

Product Code	Clear Opening A (mm)	B (mm)	Depth C (mm)	Loading (TONS)	Specifications
MC - 250 X 200 C6 2 X 3 (HD)	2500 X 2000	2640 X 2140	70	40	BS - EN 124

Heavy Duty Grey Cast Iron Multiple Covers with Mild Steel Angle Frames

Features:-

- Closed Keyholes
- Black epoxy Coated Frame
- Removable "T" bar and "I" beam
- Beam Housing Box
- For Slow Moving Traffic Only
- Not Used For High Ways
- Light Vehicle Access Only

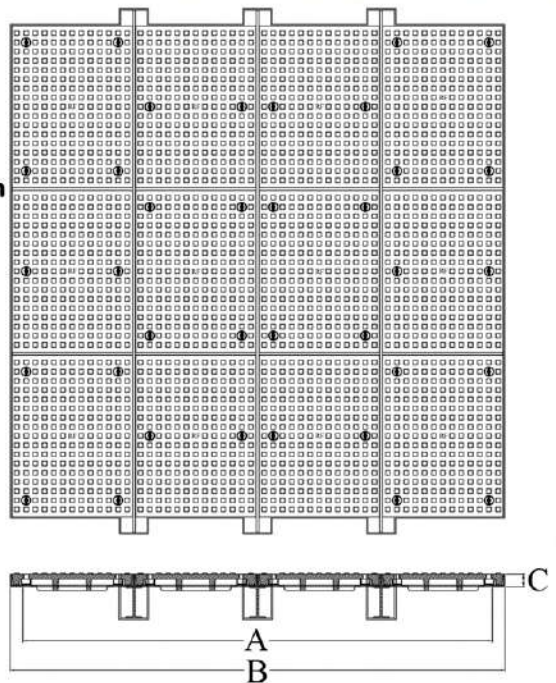

Product Code	Clear Opening A (mm)	Over Base B (mm)	Depth C (mm)	Loading (TONS)	Specifications
MC - 250 X 200 C12 3 X 4 (HD)	2500 X 2000	2660 X 2160	80	25	BS - EN 124

Heavy Duty Grey Cast Iron Multiple Covers with Mild Steel Angle Frames

Features:-

- Closed Keyholes
- Black epoxy Coated Frame
- Removable "T" bar and "I" beam
- Beam Housing Box
- For Slow Moving Traffic Only
- Not Used For High Ways
- Light Vehicle Access Only

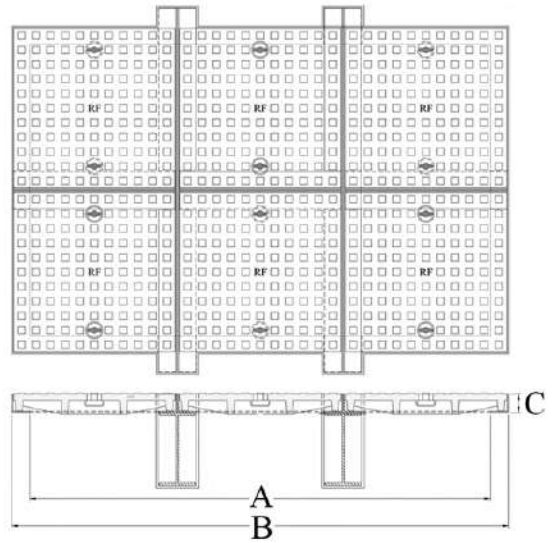

Product Code	Clear Opening A (mm)	B (mm)	Depth C (mm)	Loading (TONS)	Specifications
MC - 280 X 150 C6 2 X 3 (HD)	2800 X 1500	2960 X 1660	80	40	BS - EN 124
MC - 290 X 150 C6 2 X 3 (HD)	2900 X 1500	3060 X 1660	80	40	BS - EN 124

Heavy Duty Grey Cast Iron Multiple Covers with Mild Steel Angle Frames

Features:-

- Closed Keyholes
- Black epoxy Coated Frame
- Removable "T" bar and "I" beam
- Beam Housing Box
- For Slow Moving Traffic Only
- Not Used For High Ways
- Light Vehicle Access Only

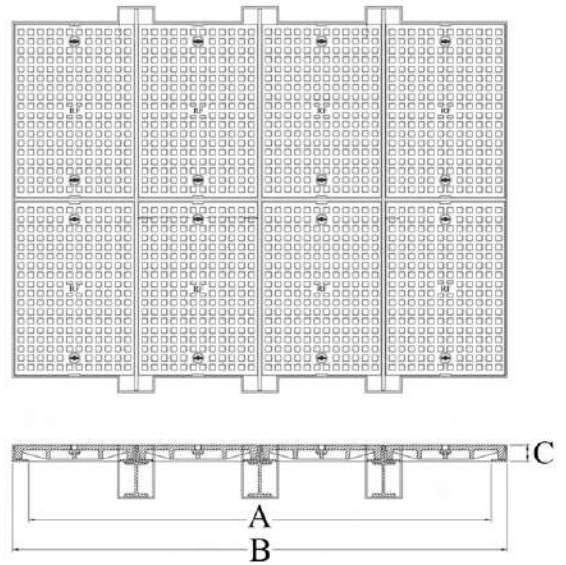

Product Code	Clear Opening A (mm)	Over Base B (mm)	Depth C (mm)	Loading (TONS)	Specifications
MC - 400 X 150 C8 2 X 4 (HD)	4000 X 1500	4140 X 1640	70	35	BS - EN 124





GULLY GRATING AND FRAMES

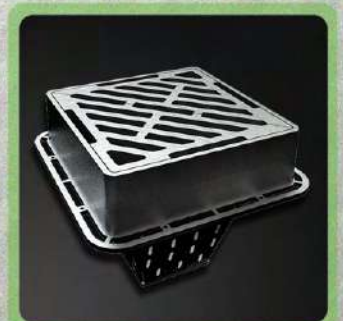
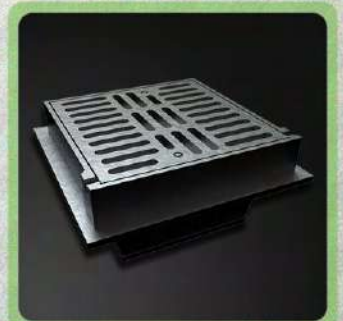

Heavy Duty Grey Cast Iron Grates and Frames with Vertical Outlet

Features:-

- Hinged Grating

Options:-

- Outlet Size to be made According Customer Requirement

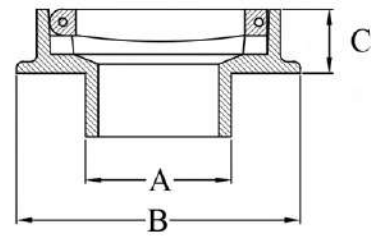
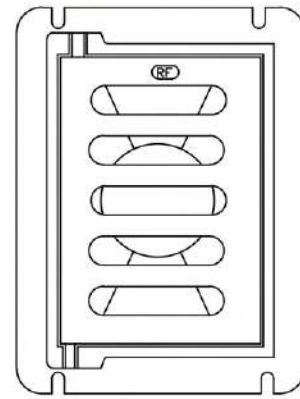

Product Code	Clear Opening A (mm)	Over Base B (mm)	Depth C (mm)	Loading (TONS)	Specifications
MC - 481 (HD)	140Ø	460 X 360	100	35	BS - EN 124

Light, Medium and Heavy Duty Grey Cast Iron Grates and Frames

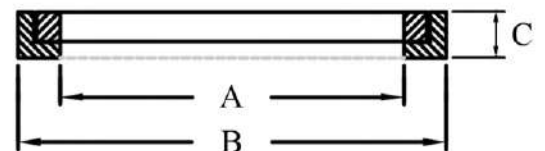
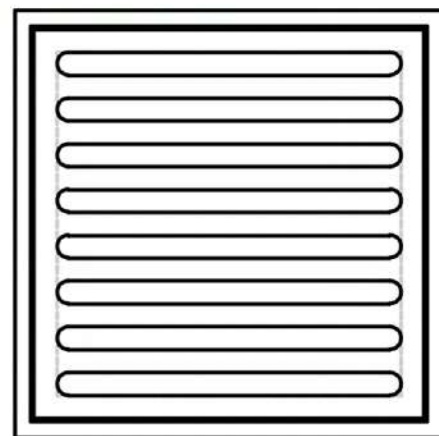

Product Code	Clear Opening A (mm)	Over Base B (mm)	Depth C (mm)	Loading (TONS)	Specifications
MC - 442 (LD)	225Sq	280Sq	30	1.5	BS - EN - 124
MC - 442 (MD)	225Sq	375Sq	30	12.5	BS - EN - 124
MC - 442 (HD)	225Sq	375Sq	75	40	BS - EN - 124



Light Duty Grey Cast Iron Grates and Frames

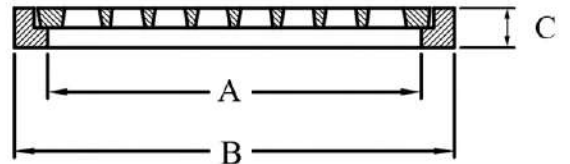
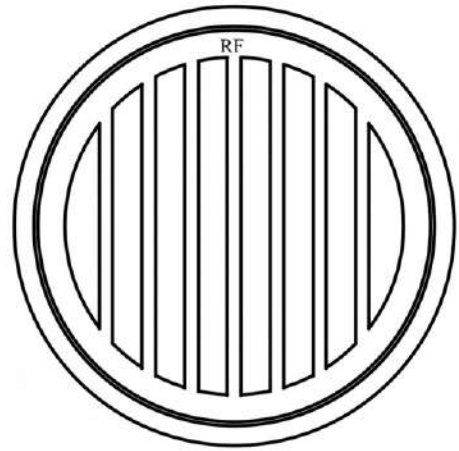

Product Code	Clear Opening A (mm)	Over Base B (mm)	Depth C (mm)	Loading (TONS)	Specifications
MC - 440 (LD)	280Ø	330Ø	30	1.5	BS - EN - 124

Heavy Duty Grey Cast Iron Grates and Frames

Features:-

- Locking Bolts
- Grate Size 370 X 370mm

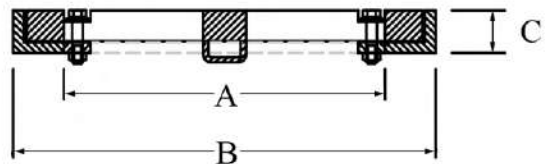
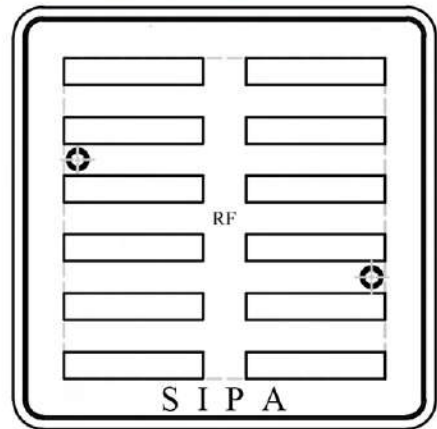

Product Code	Clear Opening A (mm)	Over Base B (mm)	Depth C (mm)	Loading (TONS)	Specifications
MC - 443 SIPA	295Sq	395Sq	40	40	BS - EN - 124

Light Medium and Heavy Duty Grey Cast Iron Grates and Frames

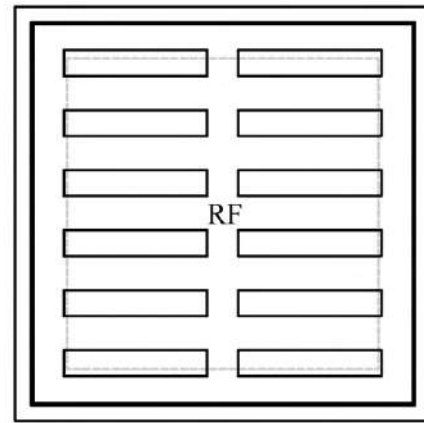

Product Code	Clear Opening A (mm)	Over Base B (mm)	Depth C (mm)	Loading (TONS)	Specifications
MC - 443 (LD)	300Sq	400Sq	40	1.5	B S - E N - 124
MC - 443 (MD)	300Sq	400Sq	40	12.5	B S - E N - 124
MC - 443 (HD)	300Sq	450Sq	50	40	B S - E N - 124
MC - 443 MR2 (MD)	300Sq	450Sq	75	12.5	B S - E N - 124
MC - 443 MR2 (HD)	300Sq	450Sq	75	40	B S - E N - 124

Heavy Duty Grey Cast Iron Grates and Frame with Aluminium Sediment Bucket

Features:-

- Hinged Grate
- Mud Bucket
- Bucket Lifting Handle
- Drain Area with Flashing Collar
- Rubber Gasket

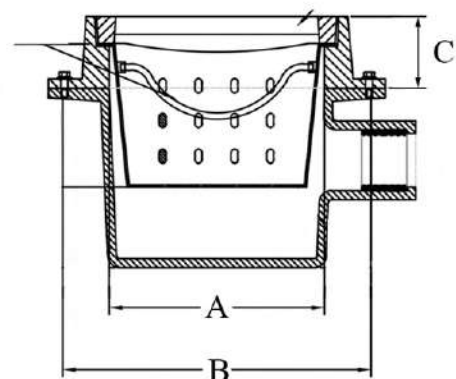
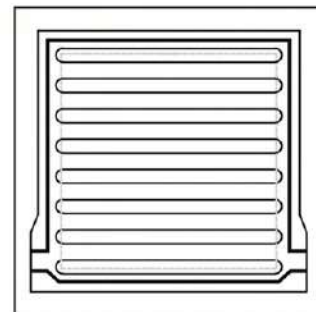

Product Code	Clear Opening A (mm)	Over Base B (mm)	Depth C (mm)	Loading (TONS)	Specifications
MC - 443 SO - 75 (HD)	300Sq	470Sq	100	40	B S - E N - 124
MC - 443 SO - 110 (HD)	300Sq	470Sq	100	40	B S - E N - 124



Light Medium and Heavy Duty Grey Cast Iron Hinged Grates and Frames

- Features:-**
 - Hinged Grate

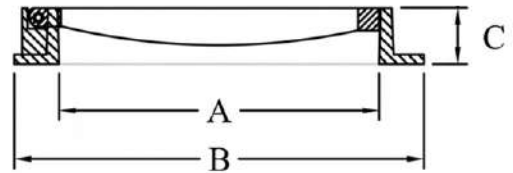
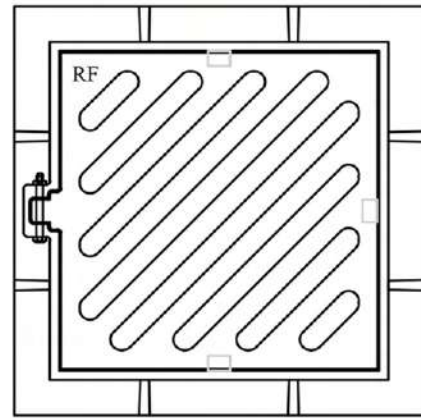

Product Code	Clear Opening A (mm)	Over Base B (mm)	Depth C (mm)	Loading (TONS)	Specifications
MC - 448 H R6 (LD)	430Sq	550Sq	75	1.5	BS - EN - 124
MC - 448 H R6 (MD)	430Sq	550Sq	75	12.5	BS - EN - 124
MC - 448 H R6 (HD)	430Sq	550Sq	75	40	BS - EN - 124

Medium and Heavy Duty Grey Cast Iron Grates and Frames

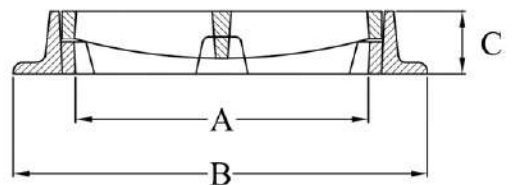
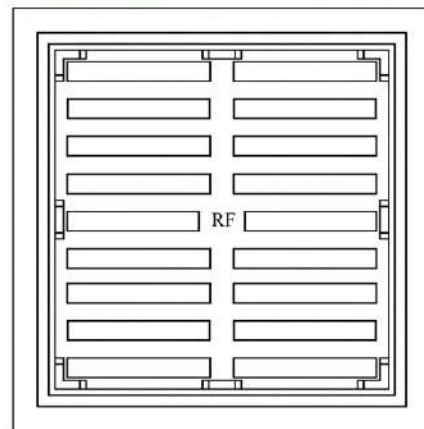

Product Code	Clear Opening A (mm)	Over Base B (mm)	Depth C (mm)	Loading (TONS)	Specifications
MC - 450 (MD)	450Sq	650Sq	140	12.5	BS - EN - 124
MC - 450 (HD)	450Sq	650Sq	140	40	BS - EN - 124
MC - 452 (HD)	500Sq	650Sq	140	40	BS - EN - 124

Heavy Duty Grey Cast Iron Grates and Frames

Features:-

- Double Triangular
- Three Point Suspension

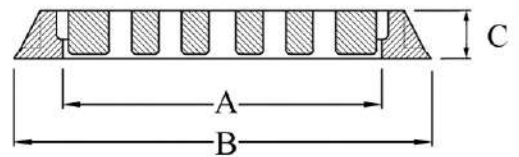
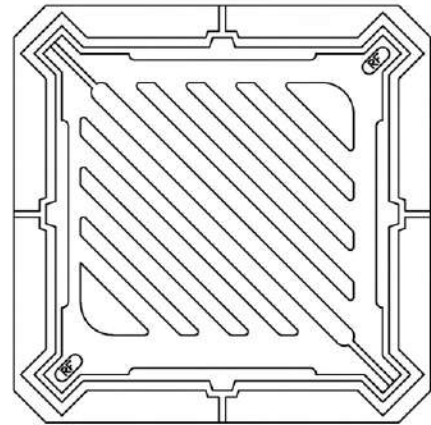

Product Code	Clear Opening A (mm)	Over Base B (mm)	Depth C (mm)	Loading (TONS)	Specifications
MC - 450 DT (HD)	450Sq	600Sq	75	40	B S - E N - 124

Heavy Duty Ductile Cast Iron Grates and Frames

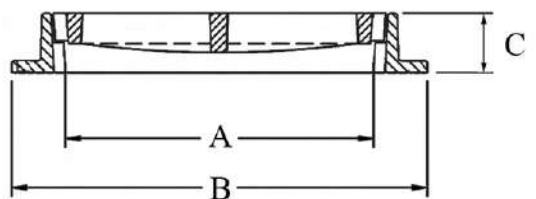
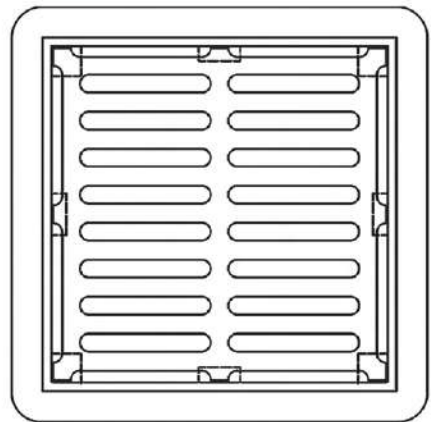

Product Code	Clear Opening A (mm)	Over Base B (mm)	Depth C (mm)	Loading (TONS)	Specifications
MC - 450 A DI (HD)	450Sq	650Sq	100	40	B S - E N - 124



Heavy Duty Ductile Cast Iron Grates and Frames

Features:-

- Double Triangular
- Three Point Suspension
- Mud Trap
- Foundation Bolt Holes

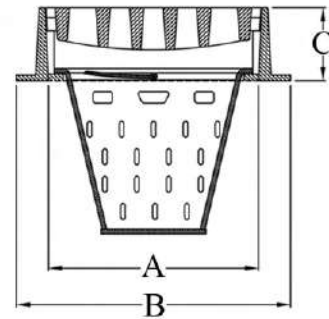
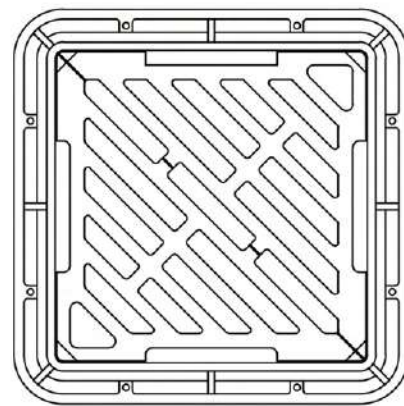

Product Code	Clear Opening A (mm)	Over Base B (mm)	Depth C (mm)	Loading (TONS)	Specifications
MC - 452 AR1DT - DI (HD)	460Sq	600Sq	160	40	BS - EN - 124

Heavy Duty Grey Cast Iron Grates and Frames

Features:-

- Double Triangular
- Three Point Suspension

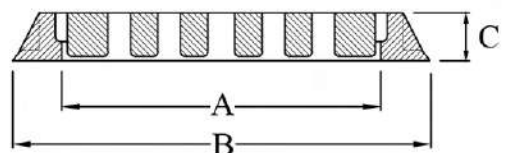
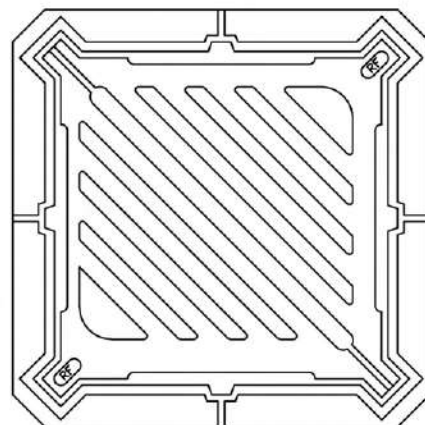

Product Code	Clear Opening A (mm)	Over Base B (mm)	Depth C (mm)	Loading (TONS)	Specifications
MC - 452 DT (HD)	500Sq	650Sq	75	40	BS - EN - 124

Medium and Heavy Duty Ductile Cast Iron Grates and Frames

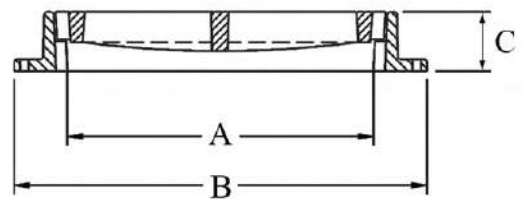
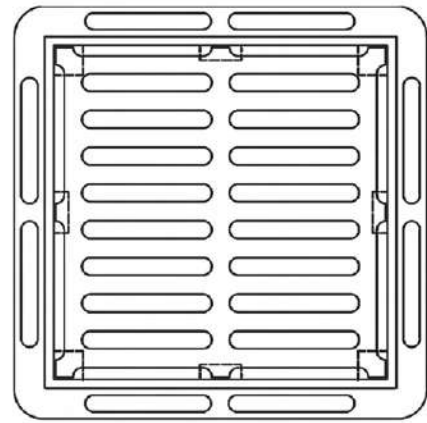

Product Code	Clear Opening A (mm)	Over Base B (mm)	Depth C (mm)	Loading (TONS)	Specifications
MC - 451 DI (MD)	500Sq	700Sq	100	12.5	BS - EN - 124
MC - 451 DI (HD)	500Sq	700Sq	100	40	BS - EN - 124

Medium and Heavy Duty Grey Cast Iron Grates and Frames

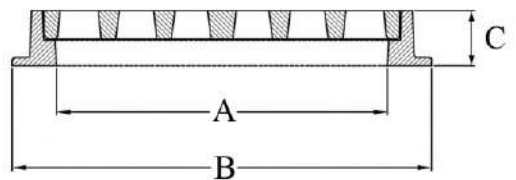
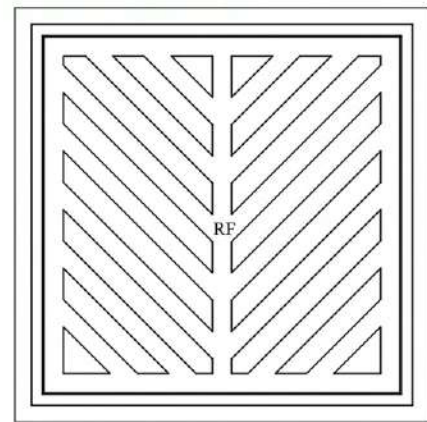

Product Code	Clear Opening A (mm)	Over Base B (mm)	Depth C (mm)	Loading (TONS)	Specifications
MC - 455 (MD)	550Sq	680Sq	75	12.5	BS - EN - 124
MC - 455 (HD)	550Sq	680Sq	100	40	BS - EN - 124

Light Medium and Heavy Duty Grey Cast Iron Grates and Frames

Options:-

- Provision for Mud Basket (Heavy Duty)

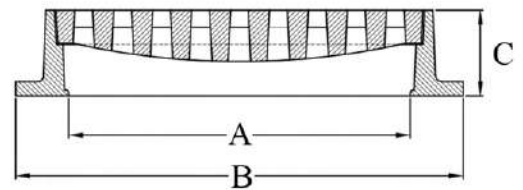
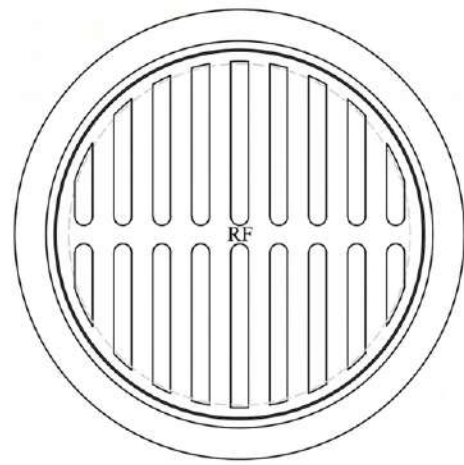

Product Code	Clear Opening A (mm)	Over Base B (mm)	Depth C (mm)	Loading (TONS)	Specifications
MC - 441 (LD)	600Ø	720Ø	75	1.5	BS - EN - 124
MC - 441 (MD)	600Ø	720Ø	75	12.5	BS - EN - 124
MC - 441 (HD)	600Ø	720Ø	150	40	BS - EN - 124

Heavy Duty Grey Cast Iron Grates and Square Frames

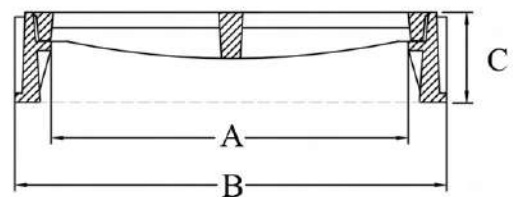
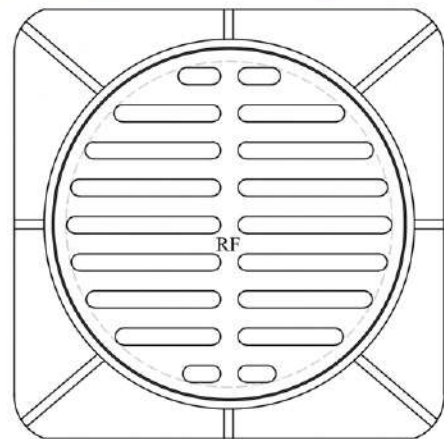

Product Code	Clear Opening A (mm)	Over Base B (mm)	Depth C (mm)	Loading (TONS)	Specifications
MC - 441SQ FR 1 (HD)	600Ø	790Sq	150	40	BS - EN - 124

Heavy Duty Ductile Cast Iron Grates and Frames

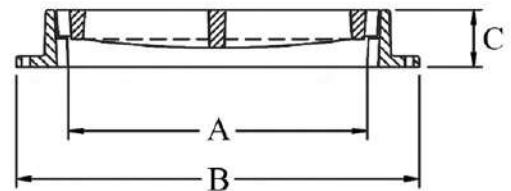
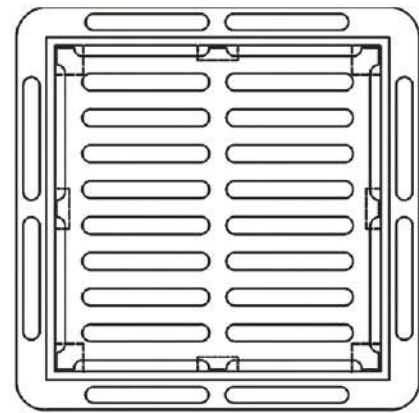

Product Code	Clear Opening A (mm)	Over Base B (mm)	Depth C (mm)	Loading (TONS)	Specifications
MC - 451 A1 DI (HD)	600Sq	800Sq	75	40	BS - EN - 124
MC - 451 A3 DI (HD)	600Sq	800Sq	150	40	BS - EN - 124

Light Medium and Heavy Duty Grey Cast Iron Grates and Frames

Features:-

- Hinged Grates

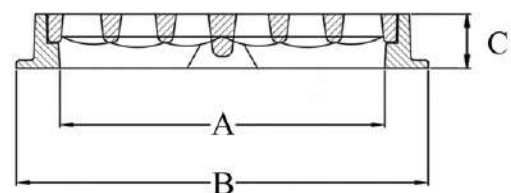
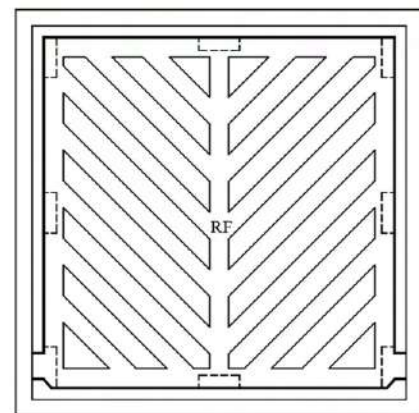

Product Code	Clear Opening A (mm)	Over Base B (mm)	Depth C (mm)	Loading (TONS)	Specifications
MC - 460 (LD)	600Sq	710Sq	50	1.5	BS - EN - 124
MC - 460 (MD)	600Sq	710Sq	100	12.5	BS - EN - 124
MC - 460 (HD)	600Sq	710Sq	150	25	BS - EN - 124
MC - 460 A (HD)	600Sq	760Sq	100	40	BS - EN - 124
MC - 460 A R2 (HD)	600Sq	760Sq	150	40	BS - EN - 124
MC - 461 (HD)	640Sq	800Sq	100	40	BS - EN - 124



Heavy Duty Grey Cast Iron Grates and Frames with Aluminium Mud Bucket

Features:-

- Hinge Grate
- Mud Bucket

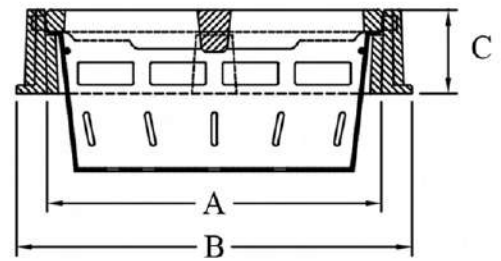
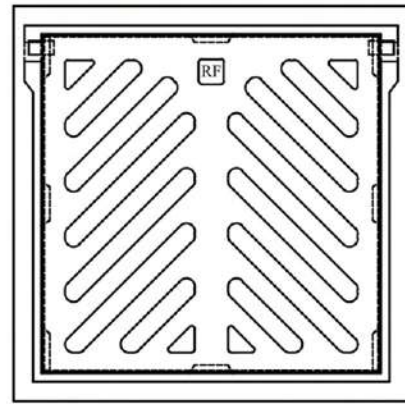

Product Code	Clear Opening A (mm)	Over Base B (mm)	Depth C (mm)	Loading (TONS)	Specifications
MC - 460 MT (HD)	600Sq	710Sq	150	25	B S - E N - 124

Heavy Duty Grey Cast Iron Grates and Frames with Hot Dip Galvanized Mild Steel Mud Bucket

Features:-

- Hinged Grating
- Locking Device
- Mud Bucket

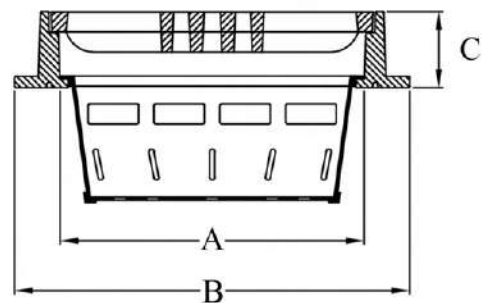
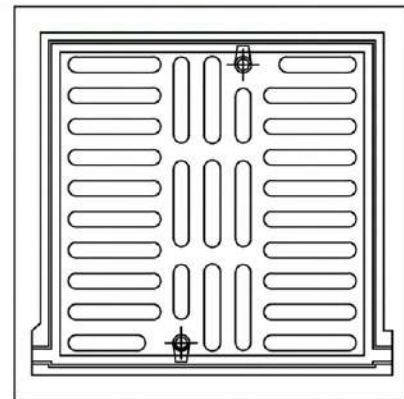

Product Code	Clear Opening A (mm)	Over Base B (mm)	Depth C (mm)	Loading (TONS)	Specifications
MC - 470 MT (HD)	600Sq	780Sq	150	40	B S - E N - 124

Heavy Duty Grey Cast Iron Grates and Frames

Features:-

- Hinged Grating
- Locking Device

Options:-

- Provision for Mud Basket

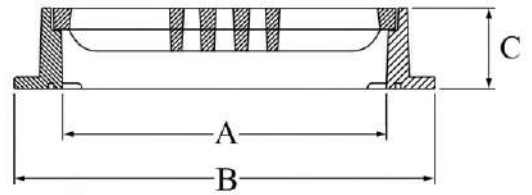
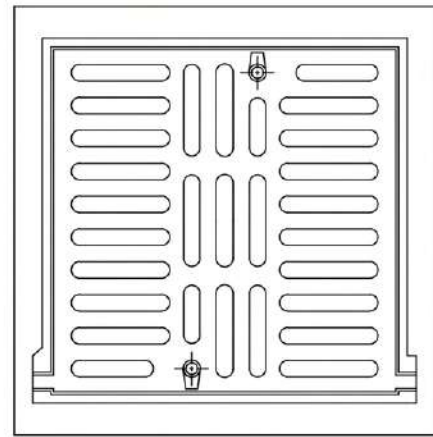

Product Code	Clear Opening A (mm)	Over Base B (mm)	Depth C (mm)	Loading (TONS)	Specifications
MC - 470 (HD)	600Sq	780Sq	150	40	B S - E N - 124

Heavy Duty Grey Cast Iron Grates and Frames

Features:-

- Hinged Grating

Options:-

- Provision for Mud Basket

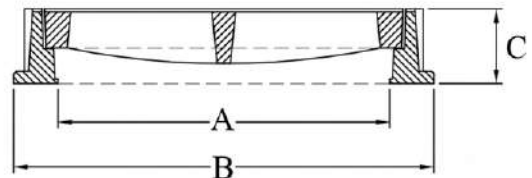
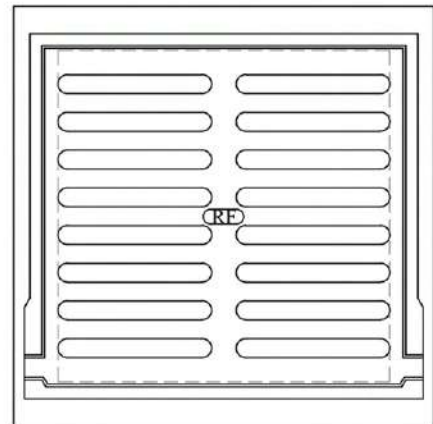

Product Code	Clear Opening A (mm)	Over Base B (mm)	Depth C (mm)	Loading (TONS)	Specifications
MC - 470 R1 (HD)	600Sq	760Sq	100	40	B S - E N - 124
MC - 470 R2 (HD)	600Sq	760Sq	135	40	B S - E N - 124



Heavy Duty Ductile Cast Iron Grates and Frames

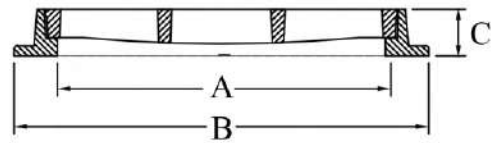
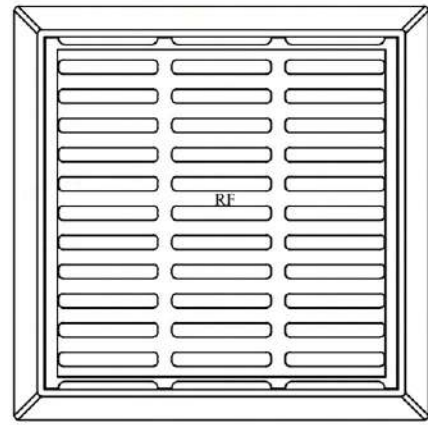

Product Code	Clear Opening A (mm)	Over Base B (mm)	Depth C (mm)	Loading (TONS)	Specifications
MC - 471 R1 DI (HD)	700Sq	860Sq	100	40	B S - E N 124

Medium and Heavy Duty Grey Cast Iron Grates and Frames

Features:-

- More Drainage Area
- Large Clear Opening

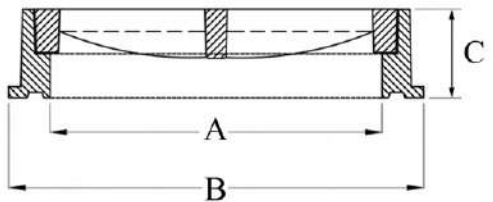
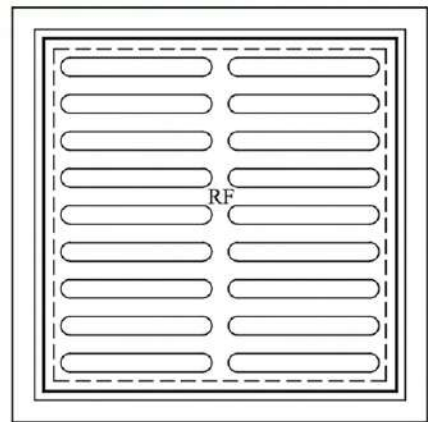

Product Code	Clear Opening A (mm)	Over Base B (mm)	Depth C (mm)	Loading (TONS)	Specifications
MC - 475 (MD) MC - 475 (HD)	750Sq 750Sq	950Sq 950Sq	160 160	12.5 40	B S - E N 124 B S - E N 124

Heavy Duty Grey Cast Iron Grates and Frames

Features:-

- More Drainage Area
- Large Clear Opening

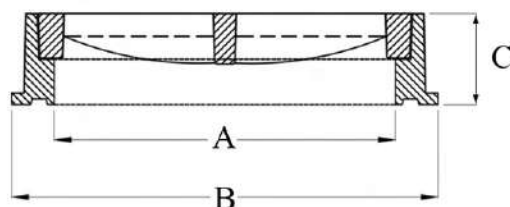
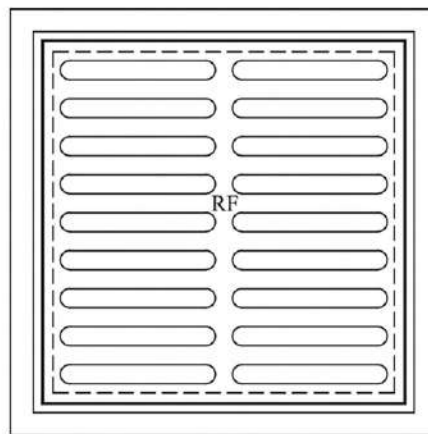

Product Code	Clear Opening A (mm)	Over Base B (mm)	Depth C (mm)	Loading (TONS)	Specifications
MC - 476 (HD)	800Sq	1000Sq	160	40	B S - E N 124

Medium and Heavy Duty Grey Cast Iron Grates and Frames

Features:-

- More Drainage Area
- Large Clear Opening

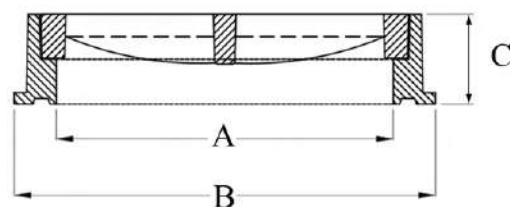
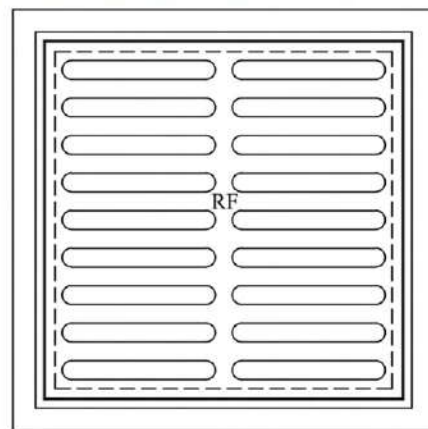

Product Code	Clear Opening A (mm)	Over Base B (mm)	Depth C (mm)	Loading (TONS)	Specifications
MC - 477 R5 A (HD)	900Sq	1150Sq	150	40	B S - E N 124



Heavy Duty Grey Cast Iron Grates and Frames

Features:-

- Large Clear Opening
- More Drainage Area

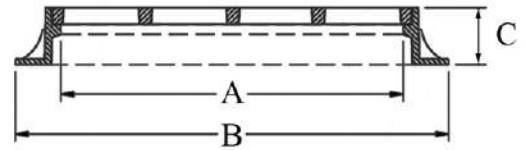
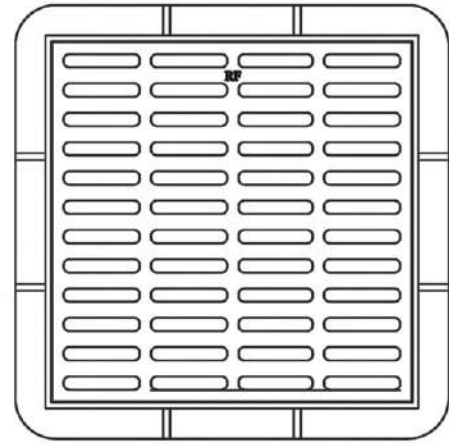

Product Code	Clear Opening A (mm)	Over Base B (mm)	Depth C (mm)	Loading (TONS)	Specifications
MC - 476 R 1 N (HD)	900Sq	1140Sq	150	40	B S - EN 124

Medium Duty Grey Cast Iron Covers and Frames

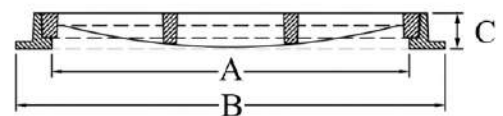
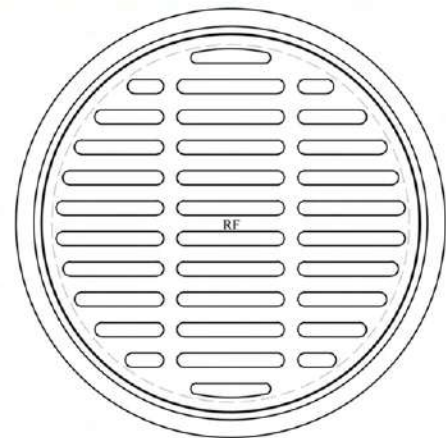

Product Code	Clear Opening A (mm)	Over Base B (mm)	Depth C (mm)	Loading (TONS)	Specifications
MC - 478 G - RO (MD)	1000Ø	1200Ø	100	15	B S - EN - 124

Heavy Duty Ductile Cast Iron Grates and Frames

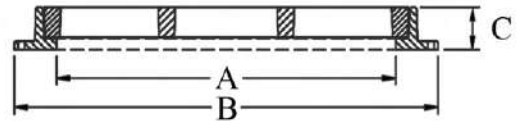
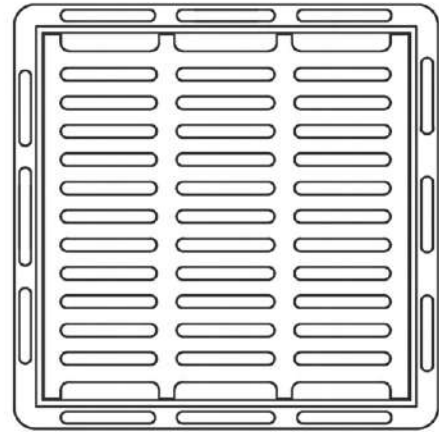

Product Code	Clear Opening A (mm)	Over Base B (mm)	Depth C (mm)	Loading (TONS)	Specifications
MC - 476 A DI (HD)	1000Sq	1200Sq	150	40	B S - E N 124

Heavy Duty Grey Cast Iron Grates and Frames

Features:-

- Large Clear Opening
- More Drainage Area
- Individual Side Frame Bolted Together With Double Grate

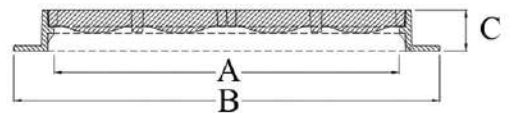
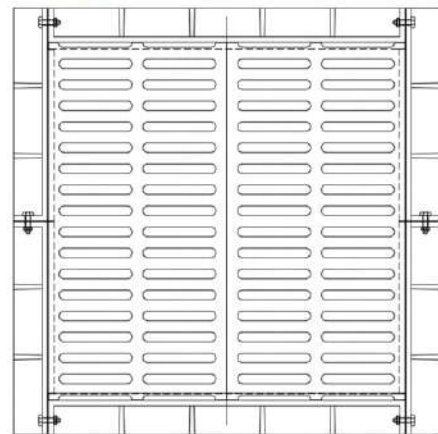

Product Code	Clear Opening A (mm)	Over Base B (mm)	Depth C (mm)	Loading (TONS)	Specifications
MC - 476 A R1 N (HD)	1200Sq	1500Sq	150	40	B S - E N - 124



Heavy Duty Grey Cast Iron Grates and Frames

Features:-

- Large Clear Opening
- More Drainage Area
- Individual Side Frame Bolted Together With Double Grate

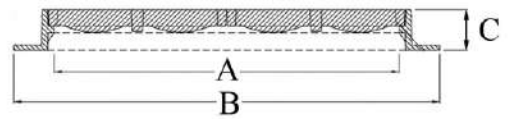
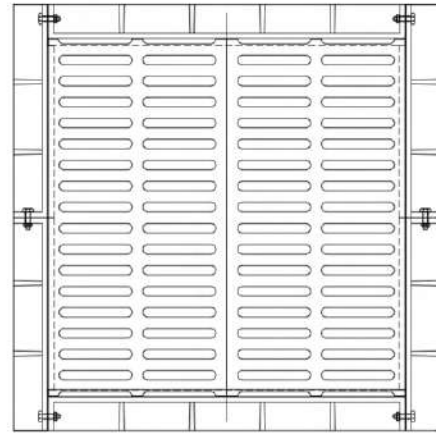

Product Code	Clear Opening A (mm)	Over Base B (mm)	Depth C (mm)	Loading (TONS)	Specifications
MC - 476 A R2 N (HD)	1270Sq	1570Sq	150	40	BS - EN - 124

Heavy Duty Ductile Cast Iron Grates and Frames

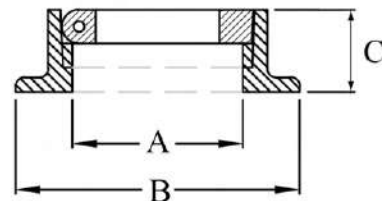
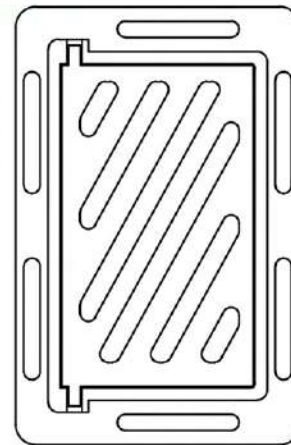

Product Code	Clear Opening A (mm)	Over Base B (mm)	Depth C (mm)	Loading (TONS)	Specifications
MC - 450 R DI (HD)	210 X 400	350 X 540	75	40	BS - EN - 124

Heavy Duty Grey Cast Iron Grates and Frames

Features:-

- Double Triangular
- Three Point Suspension
- Four Foundation Bolt Holes

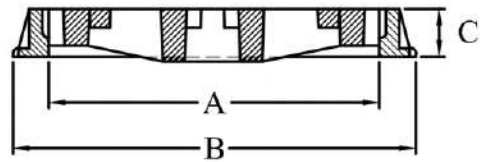
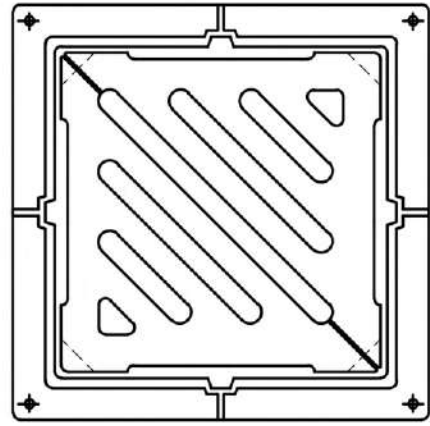

Product Code	Clear Opening A (mm)	Over Base B (mm)	Depth C (mm)	Loading (TONS)	Specifications
MC - 443 DT (HD)	300 X 300	450 X 450	80	40	BS - EN - 124

Medium and Heavy Duty Ductile Cast Iron Hinged Grates and Frames

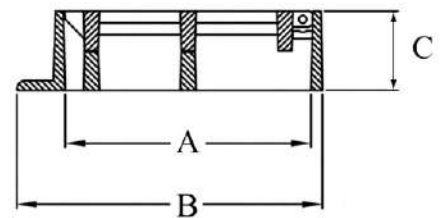
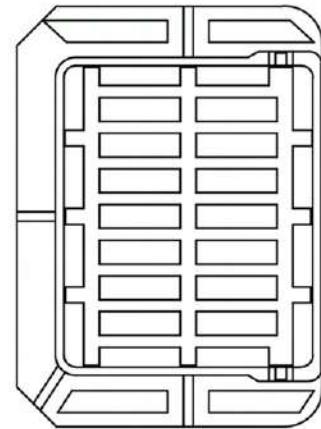

Product Code	Clear Opening A (mm)	Over Base B (mm)	Depth C (mm)	Loading (TONS)	Specifications
MC - 491 B (MD)	310 X 380	385 X 530	100	12.5	BS - EN 124
MC - 491 B (HD)	310 X 380	385 X 530	100	40	BS - EN 124

Medium and Heavy Duty Ductile Cast Iron Hinged Grates and Frames

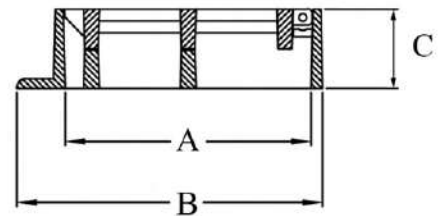
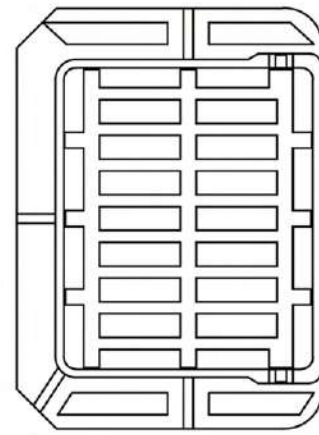

Product Code	Clear Opening A (mm)	Over Base B (mm)	Depth C (mm)	Loading (TONS)	Specifications
MC - 491 A (MD)	317 X 385	400 X 535	100	12.5	B S - E N 124
MC - 491 A (HD)	317 X 385	400 X 535	100	40	B S - E N 124

Medium Duty Grey Cast Iron Grates and Frames

Features:-

- Hinged Grating

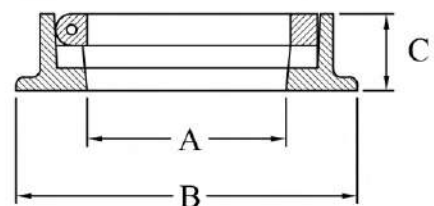
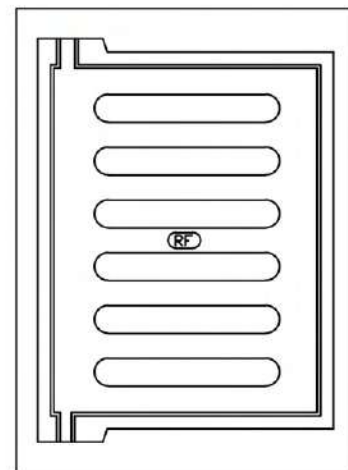

Product Code	Clear Opening A (mm)	Over Base B (mm)	Depth C (mm)	Loading (TONS)	Specifications
MC - 480 (MD)	320 X 210	460 X 360	75	12.5	B S - E N 124

Medium and Heavy Duty Grey Cast Iron Grates and Frames

Features:-

- Hinged Grating

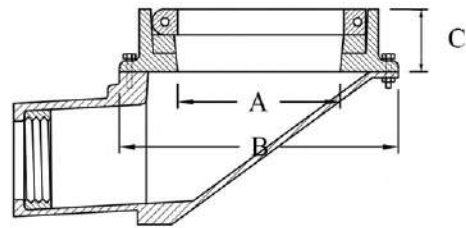
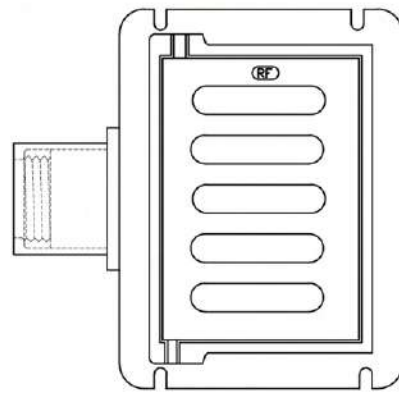

Product Code	Clear Opening A (mm)	Over Base B (mm)	Depth C (mm)	Loading (TONS)	Specifications
MC - 480 A (MD)	320 X 210	460 X 360	75	12.5	B S - EN 124
MC - 480 A (HD)	320 X 210	460 X 360	75	25	B S - EN 124

Heavy Duty Grey Cast Iron Grates and Frames with Vertical Outlet

Features:-

- Hinged Gratings
- Outlet Size to be made According Customer Requirement

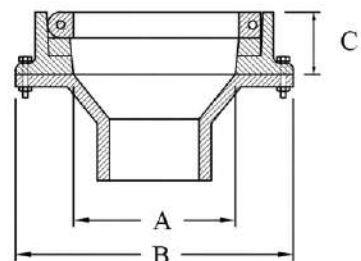
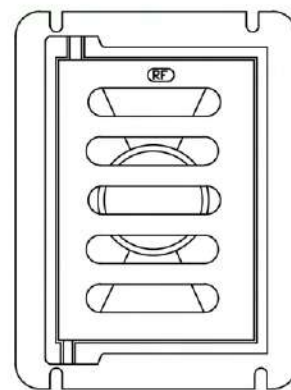

Product Code	Clear Opening A (mm)	Over Base B (mm)	Depth C (mm)	Loading (TONS)	Specifications
MC - 480 B (HD)	320 X 210	460 X 360	75	35	B S - EN 124



Medium and Heavy Duty Ductile Cast Iron Hinged Grates and Frames

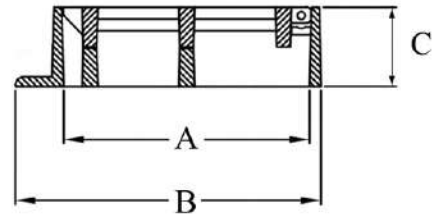
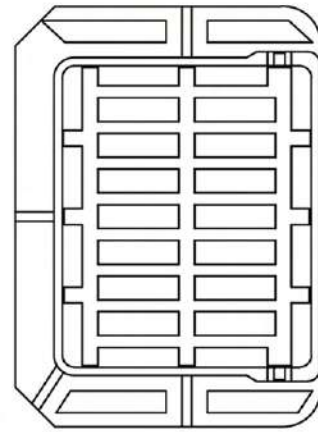

Product Code	Clear Opening A (mm)	Over Base B (mm)	Depth C (mm)	Loading (TONS)	Specifications
MC - 491 C (MD)	370 X 435	450 X 585	100	12.5	BS - EN 124
MC - 491 C (HD)	370 X 435	450 X 585	100	40	BS - EN 124

Medium and Heavy Duty Ductile Cast Iron Hinged Grates and Frames

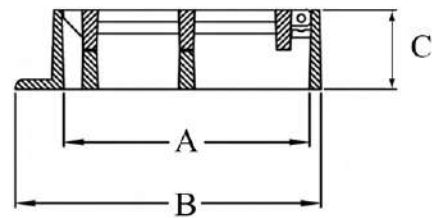
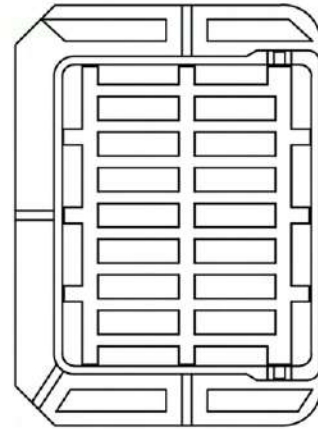

Product Code	Clear Opening A (mm)	Over Base B (mm)	Depth C (mm)	Loading (TONS)	Specifications
MC - 491 D (MD)	395 X 440	475 X 590	100	12.5	BS - EN 124
MC - 491 D (HD)	395 X 440	475 X 590	100	40	BS - EN 124

Medium and Heavy Duty Ductile Cast Iron Grates and Frames

Features:-

- Hinged Gratings
- Dish Type Grates

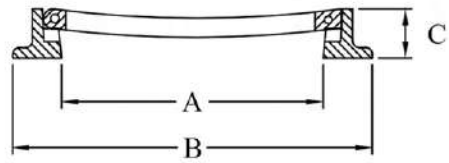
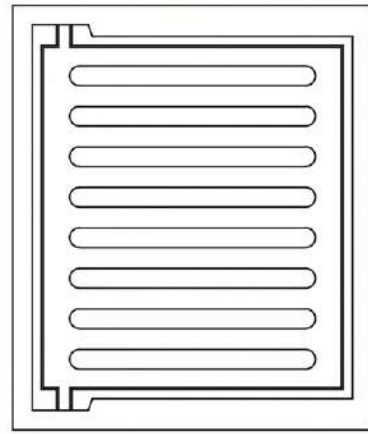

Product Code	Clear Opening A (mm)	Over Base B (mm)	Depth C (mm)	Loading (TONS)	Specifications
MC - 481 R D I (MD) MC - 481 R D I (HD)	400 X 500 400 X 500	550 X 650 550 X 650	75 75	12.5 40	B S - E N 124 B S - E N 124

Medium Duty Grey Cast Iron Grates and Frames

Features:-

- Hinged Grating

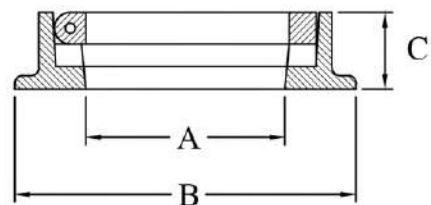
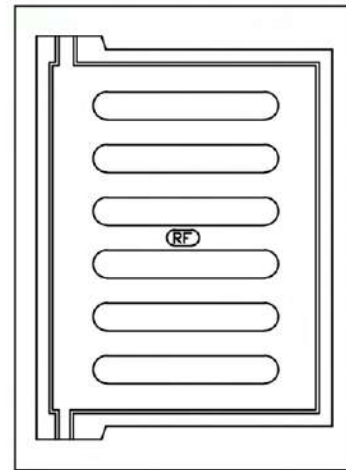

Product Code	Clear Opening A (mm)	Over Base B (mm)	Depth C (mm)	Loading (TONS)	Specifications
MC - 481 (MD)	410 X 300	600 X 450	150	12.5	B S - E N 124

Heavy Duty Grey Cast Iron Grates and Frames

Features:-

- Locking Bolts
- Grate Size 500 X 350mm

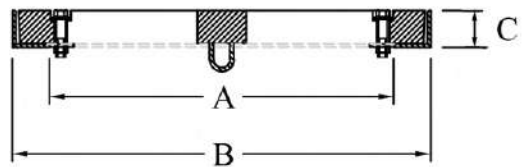
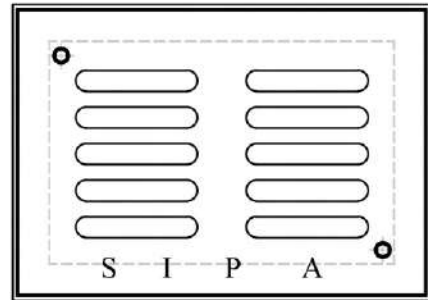

Product Code	Clear Opening A (mm)	Over Base B (mm)	Depth C (mm)	Loading (TONS)	Specifications
MC - 446 SIPA	425 X 275	525 X 375	50	40	BS - EN -124

Heavy Duty Grey Cast Iron Grates and Frames

Features:-

- Hinged Grating

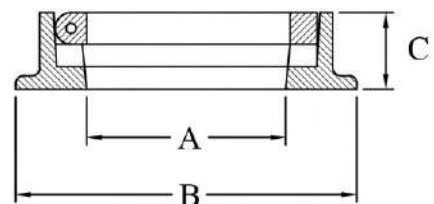
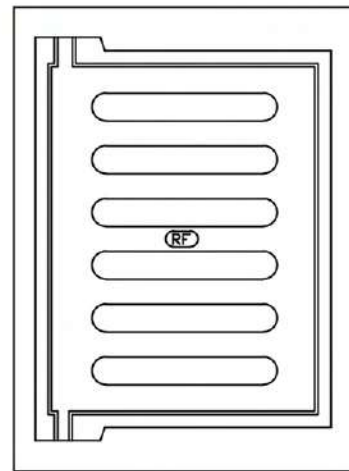

Product Code	Clear Opening A (mm)	Over Base B (mm)	Depth C (mm)	Loading (TONS)	Specifications
MC - 480 (HD)	430 X 370	600 X 540	75	40	BS - EN 124

Heavy Duty Ductile Cast Iron Grates and Frames

Features:-

- Hinged Gratings

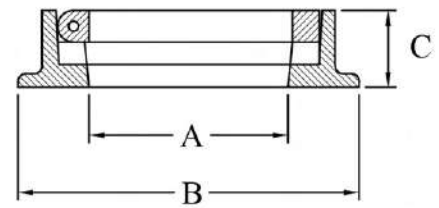
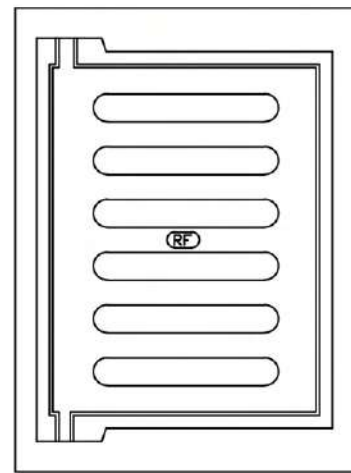

Product Code	Clear Opening A (mm)	Over Base B (mm)	Depth C (mm)	Loading (TONS)	Specifications
MC - 480 D I (HD) MC - 480 R D I (HD)	430 X 370 450 X 400	600 X 540 600 X 550	75 75	40 40	B S - EN 124 B S - EN 124

Heavy Duty Grey Cast Iron Kerb Gully

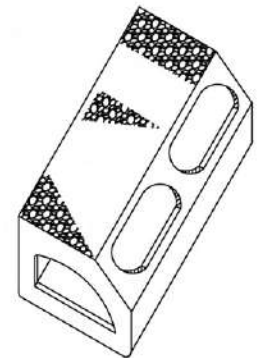
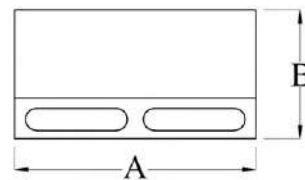
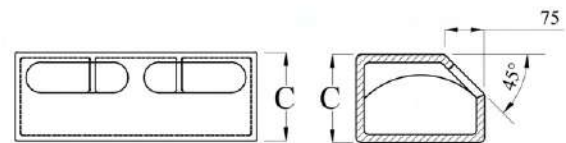

Product Code	Over Base A X B (mm)	Depth C (mm)	Loading (TONS)	Specifications
RF - CG - 485	450 X 240	165	40	B S - EN 124

Heavy Duty Grey Cast Iron Grates

Features:-

- Locking Bolts
- Grate Size 495 X 345mm

Options:-

- Mild Steel Angle Frame 40 X 40 X 4mm
- Black Epoxy Coated Frame (or) Hot Dip Galvanized Frame

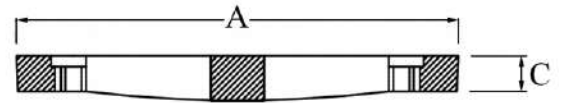
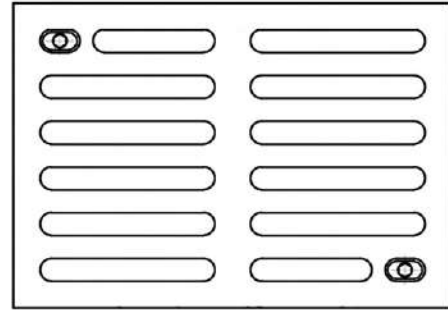

Product Code	Grate Size A (mm)	Grate Depth C (mm)	Loading (TONS)	Specifications
MC - 495 X 345 (HD)	495 X 345	30	40	BS - EN - 124

Heavy Duty Grey Cast Iron Kerb Gully

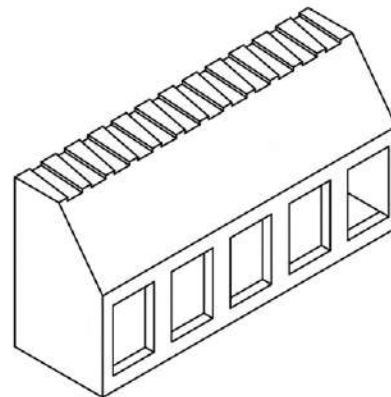
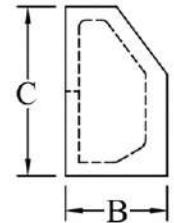
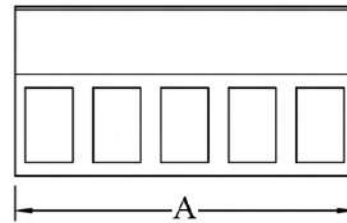

Product Code	Over Base A X B (mm)	Depth C (mm)	Loading (TONS)	Specifications
KGG - 50 X 15 (HD)	500 X 150	250	40	BS - EN 124

Heavy Duty Grey Cast Iron Kerb Gully

Features:-

- Large Kerb Drainage

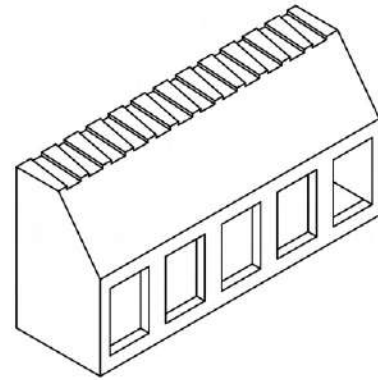
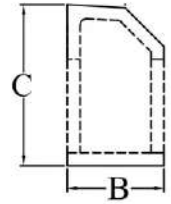
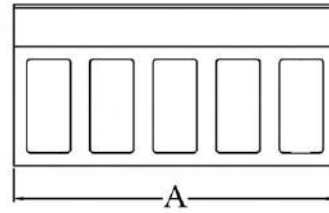

Product Code	Over Base A X B (mm)	Depth C (mm)	Loading (TONS)	Specifications
RF - CG - 484	500 X 150	250	40	B S - EN 124

Heavy Duty Grey Cast Iron Grate and Frame with Kerb Gully

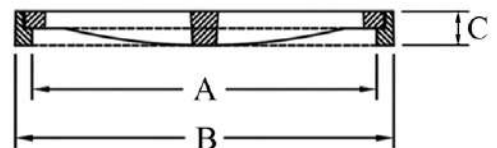
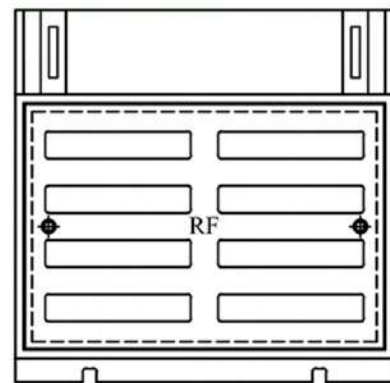

Product Code	Clear Opening A (mm)	Over Base B (mm)	Depth C (mm)	Loading (TONS)	Specifications
MC - 490 KB (HD)	510 X 340	560 X 550	50	40	B S - EN 124

Heavy Duty Grey Cast Iron Kerb Gully with Frame

Features:-

- Kerb Inlet
- Kerb Box

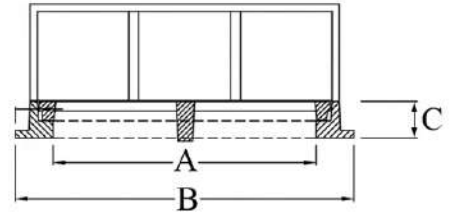
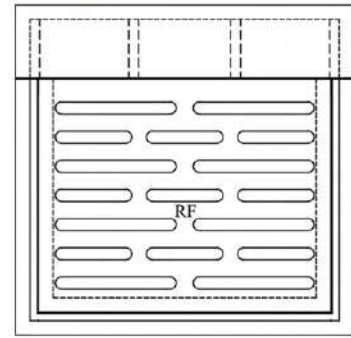

Product Code	Clear Opening A (mm)	Over Base B (mm)	Depth C (mm)	Loading (TONS)	Specifications
MC - 483 KBG (HD)	540 X 450	695 X 680	75 / 200	40	BS - EN 124

Heavy Duty Grey Cast Iron Kerb Gully

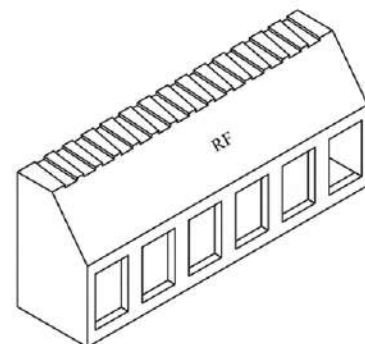
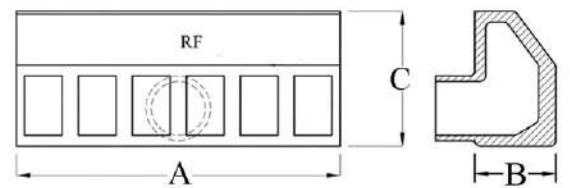

Product Code	Over Base A X B (mm)	Depth C (mm)	Loading (TONS)	Specifications
KGG - 563X150X110 (HD)	563 X 150	240	40	BS - EN 124

Heavy Duty Grey Cast Iron Grates and Frames

Features:-

- More Drainage Area
- Large Clear Opening

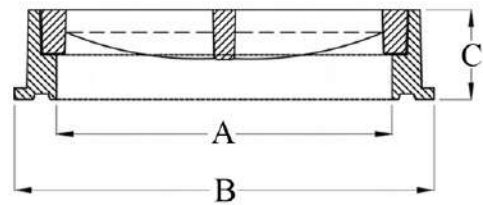
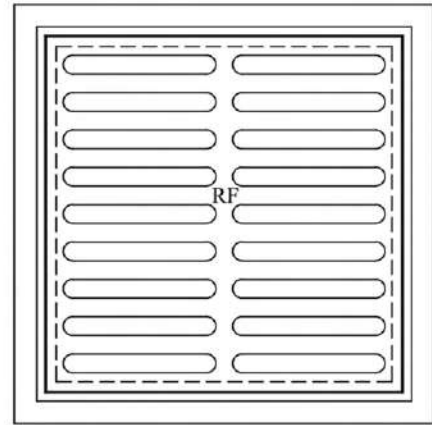

Product Code	Clear Opening A (mm)	Over Base B (mm)	Depth C (mm)	Loading (TONS)	Specifications
MC - 479 (HD)	580 X 880	730 X 1030	100	40	B S - E N 124

Heavy Duty Grey Cast Iron Grates and Frames

Features:-

- Double Triangular
- Three Point Suspension
- Four Foundation Bolt Holes

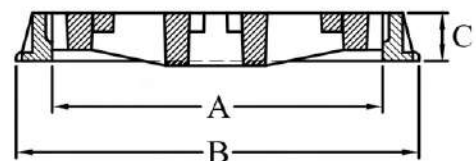
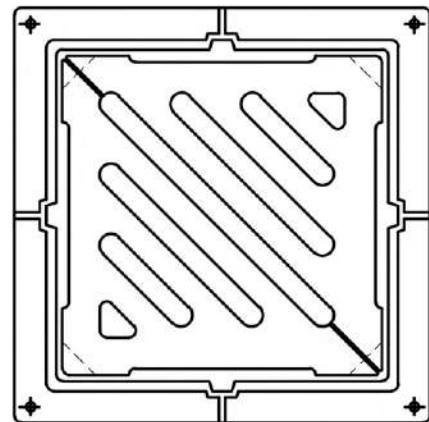

Product Code	Clear Opening A (mm)	Over Base B (mm)	Depth C (mm)	Loading (TONS)	Specifications
MC - 443 ADT (HD)	600 X 600	760 X 760	150	40	B S - E N - 124



Heavy Duty Ductile Cast Iron Grates and Frames

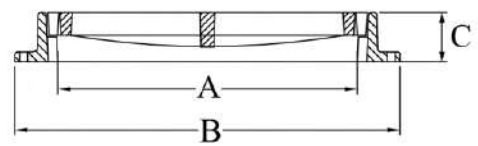
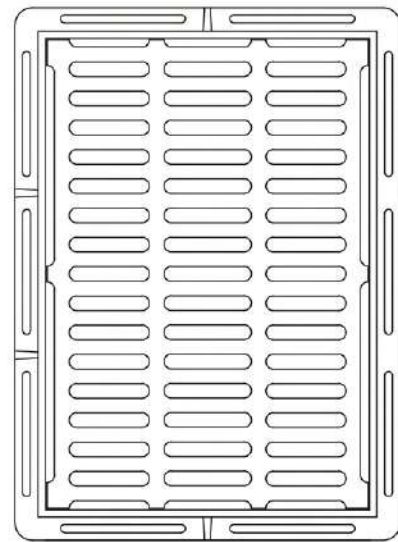

Product Code	Clear Opening A (mm)	Over Base B (mm)	Depth C (mm)	Loading (TONS)	Specifications
MC - 457 DI (HD)	600 X 900	760 X 1060	80	40	BS - EN - 124

Heavy Duty Grey Cast Iron Grates and Frames

- Features:-**
 - Hinged Grate

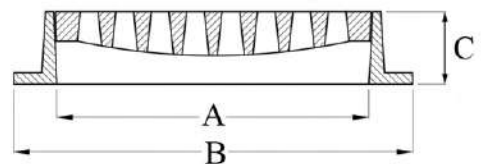
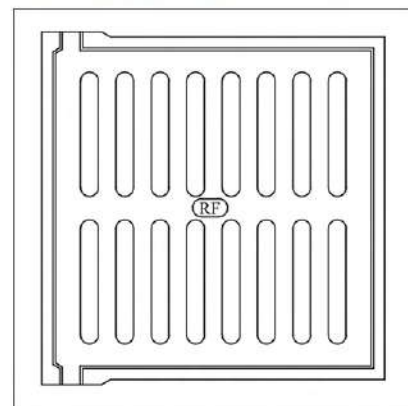

Product Code	Clear Opening A (mm)	Over Base B (mm)	Depth C (mm)	Loading (TONS)	Specifications
MC - 465 (HD)	600 X 530	750Sq	150	25	BS - EN - 124

Heavy Duty Grey Cast Iron Grates and Frames

Features:-

- More Drainage Area
- Square Grate Opening

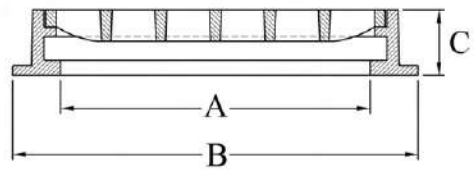
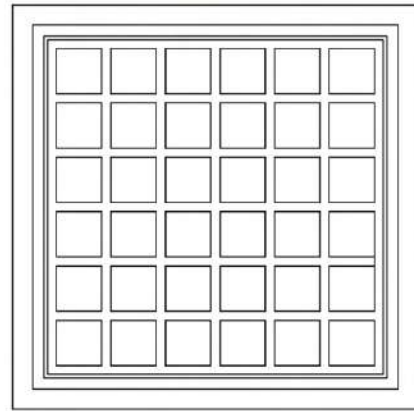

Product Code	Clear Opening A (mm)	Over Base B (mm)	Depth C (mm)	Loading (TONS)	Specifications
MC - 477 (HD)	600 X 520	750Sq	200	40	B S - E N 124

Heavy Duty Ductile Cast Iron Grates and Frames

Features:-

- Hinged Gratings

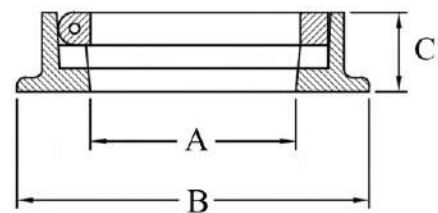
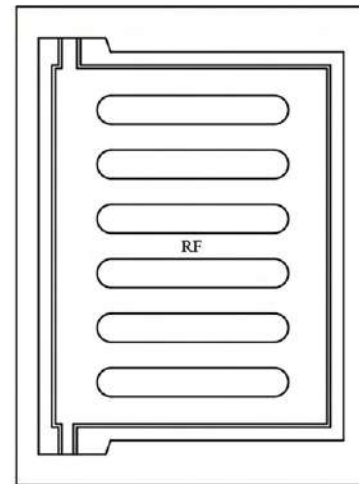

Product Code	Clear Opening A (mm)	Over Base B (mm)	Depth C (mm)	Loading (TONS)	Specifications
MC - 480 R1 D I (HD)	600 X 450	750 X 600	75	40	B S - E N 124

Heavy Duty Grey Cast Iron Hinged and Kerb Box Grate with Kerb Inlet Frame

Features:-

- Hinged Grate
- Side Box Inlet

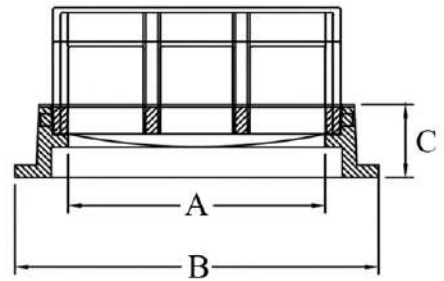
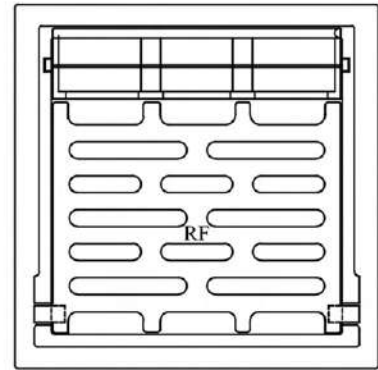

Product Code	Clear Opening A (mm)	Over Base B (mm)	Depth C (mm)	Loading (TONS)	Specifications
MC - 475 KB (HD)	600 X 530	750Sq	150	25	BS - EN 124

Heavy Duty Grey Cast Iron Grates and Frames

Features:-

- Locking Bolts
- Grate Size 700 X 400mm

Options:-

- Mild Steel Angle Frame 50 X 50 X 5mm
- Black Epoxy Coating Frame (or) Hot Dip Galvanized Frame

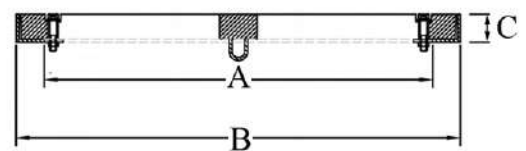
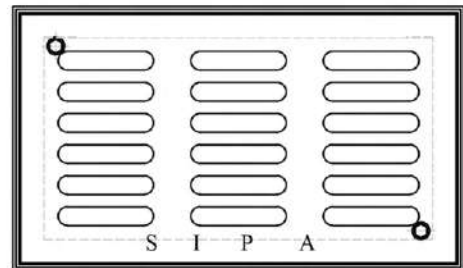

Product Code	Clear Opening A (mm)	Over Base B (mm)	Depth C (mm)	Loading (TONS)	Specifications
MC - 445 R1 SIPA	625 X 325	725 X 425	50	40	BS - EN - 124

Heavy Duty Grey Cast Iron Grates and Frames

Features:-

- More Drainage Area
- Large Clear Opening

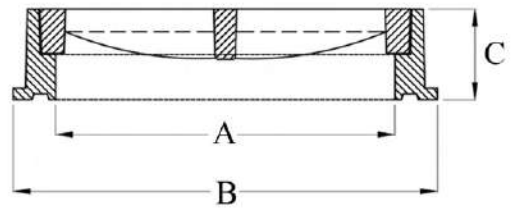
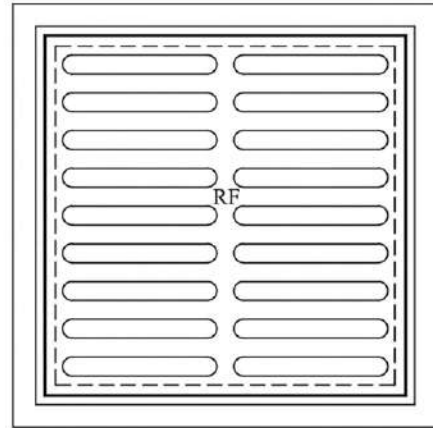

Product Code	Clear Opening A (mm)	Over Base B (mm)	Depth C (mm)	Loading (TONS)	Specifications
MC - 472 R1 A (HD)	625 X 750	825 X 950	100	40	BS - EN 124

Heavy Duty Grey Cast Iron Hinged Grates and Frames

Features:-

- Hinged Grate

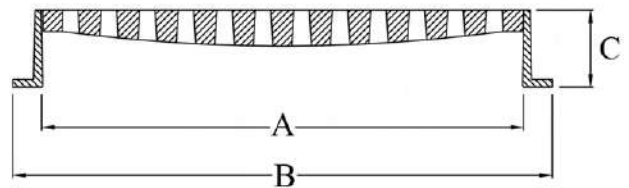
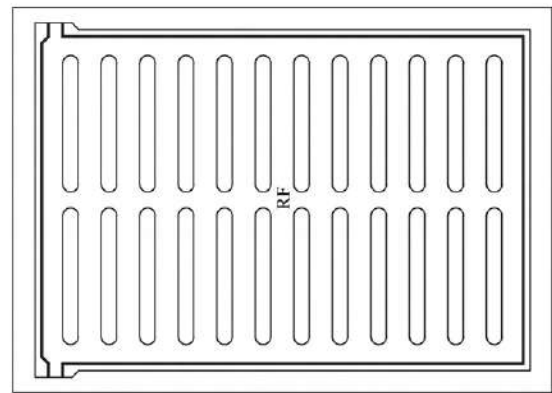

Product Code	Clear Opening A (mm)	Over Base B (mm)	Depth C (mm)	Loading (TONS)	Specifications
MC - 465 A R5 / 40 (HD)	900 X 600	1050 X 750	150	40	BS - EN - 124
MC - 466 A R5 (HD)	900 X 600	1050 X 750	150	25	BS - EN - 124

Heavy Duty Grey Cast Iron Kerb Gully with Mild Steel Frame

Features:-

- Kerb Inlet
- Kerb Box
- Galvanized Mild Steel Angle Frame
- Angle Frame 75 X 50mm

Options:-

- Black Epoxy Coated Mild Steel Frame

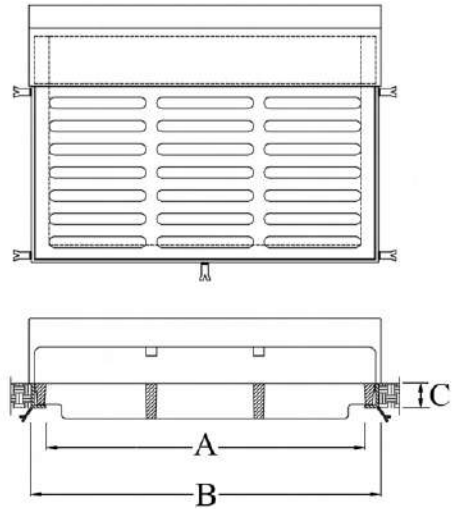

Product Code	Clear Opening A (mm)	Over Base B (mm)	Depth C (mm)	Loading (TONS)	Specifications
MC 480 KB - R2 (HD)	905 X 450	1000 X 730	75	40	BS - EN 124

Medium and Heavy Duty Grey Cast Iron Grates and Frames

Features:-

- Twin Double Triangular
- Three Point Suspension

ROYAL COMMISSION PROJECT

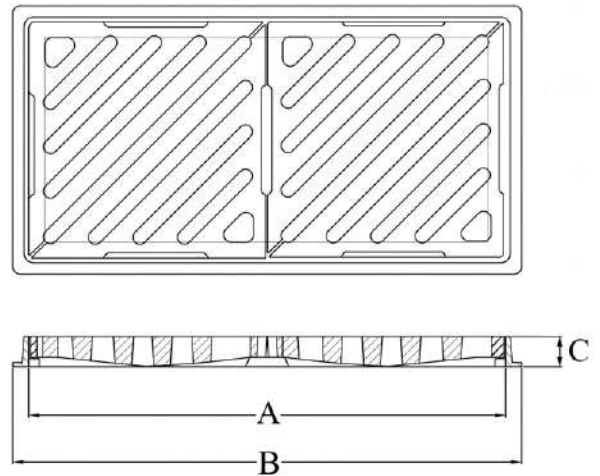

Product Code	Clear Opening A (mm)	Over Base B (mm)	Depth C (mm)	Loading (TONS)	Specifications
MC - 485 R 1 G (MD)	1000 X 450	1200 X 650	75	12.5	BS - EN 124
MC - 485 R 1 G (HD)	1000 X 450	1200 X 650	75	40	BS - EN 124



Heavy Duty Grey Cast Iron Double Grate with Mild Steel Angle Frame

Features:-

- Galvanized Steel Frame
- Angle Frame 80 X 80 X 6mm

Options:-

- Removable "T" Bar and "I" Beam
- Black Epoxy Coated Frame
- Beam Housing Box

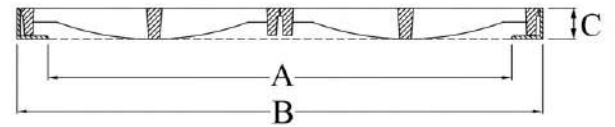
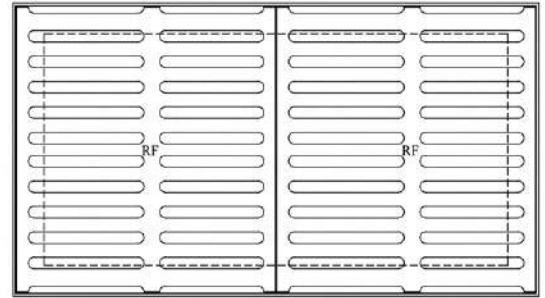

Product Code	Clear Opening A (mm)	Over Base B (mm)	Depth C (mm)	Loading (TONS)	Specifications
MC - 100 X 75 G 2 (HD)	1000 X 750	1160 X 910	80	40	BS - EN 124

Heavy Duty Grey Cast Iron Grates and Frames

Features:-

- Double Grates and Single Frames

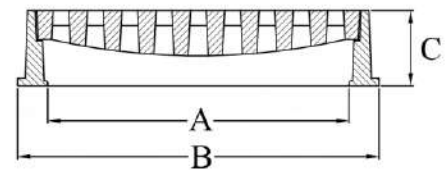
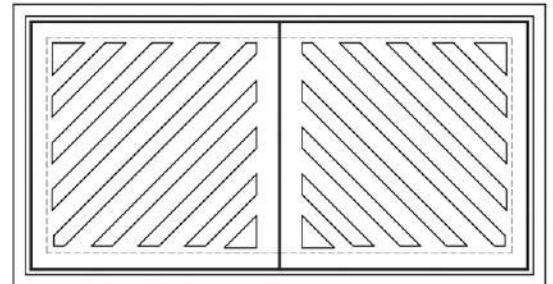

Product Code	Clear Opening A (mm)	Over Base B (mm)	Depth C (mm)	Loading (TONS)	Specifications
MC - 485 (HD)	1010 X 450	1200 X 640	150	25	BS - EN 124



Medium and Heavy Duty Grey Cast Iron Grates and Frames

Features:-

- Twin Double Triangular
- Three Point Suspension

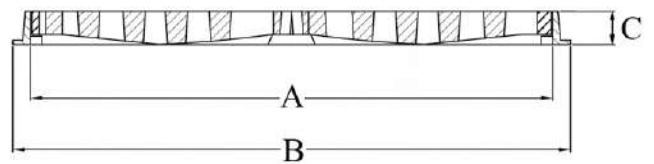
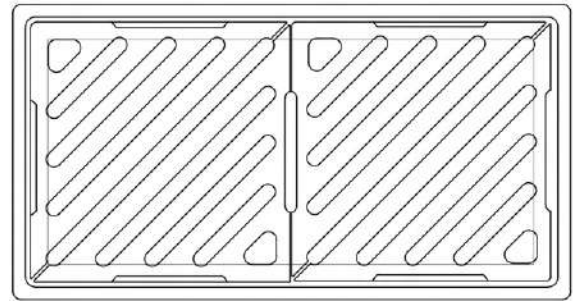

Product Code	Clear Opening A (mm)	Over Base B (mm)	Depth C (mm)	Loading (TONS)	Specifications
MC - 485 MT (MD)	1200 X 600	1350 X 750	75	12.5	BS - EN 124
MC - 485 MT (HD)	1200 X 600	1350 X 750	75	40	BS - EN 124

Heavy Duty Ductile Cast Iron Hinged Grates and Frames

Features:-

- Grate Hinged

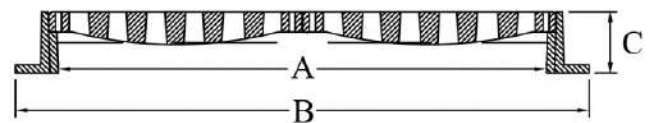
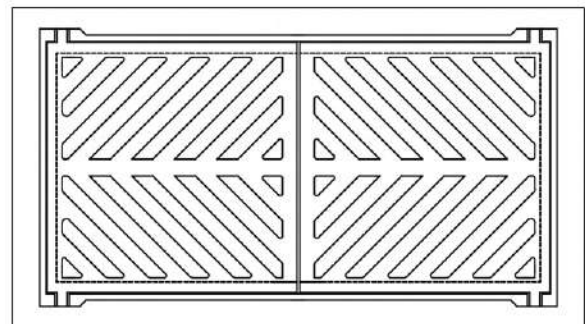

Product Code	Clear Opening A (mm)	Over Base B (mm)	Depth C (mm)	Loading (TONS)	Specifications
MC - 485 DH DI (HD)	1200 X 600	1400 X 800	100	40	BS - EN 124

Heavy Duty Grey Cast Iron Double Grate with Mild Steel Angle Frame

Features:-

- Galvanized Steel Frame
- Angle Frame 80 X 80 X 6mm

Options:-

- Removable "T" Bar and "I" Beam
- Black Epoxy Coated Frame
- Beam Housing Box

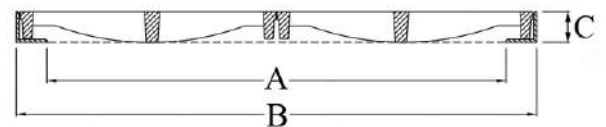
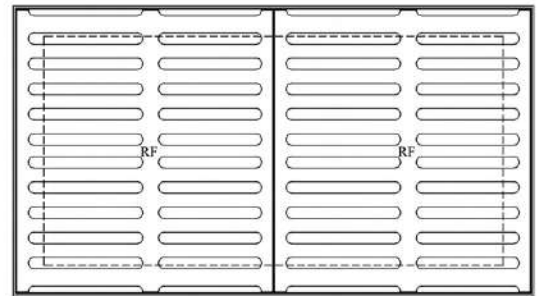

Product Code	Clear Opening A (mm)	Over Base B (mm)	Depth C (mm)	Loading (TONS)	Specifications
MC - 120 X 60 G 2 (HD)	1200 X 600	1360 X 760	80	40	BS - EN 124

Heavy Duty Ductile Cast Iron Grates with Mild Steel Angle Frame

Features:-

- Galvanized Steel Frame
- Removable "T" Bar and "I" Beam
- Beam Housing Box
- Angle Frame 70 X 70 X 7mm

Options:-

- Black Epoxy Coated Frame

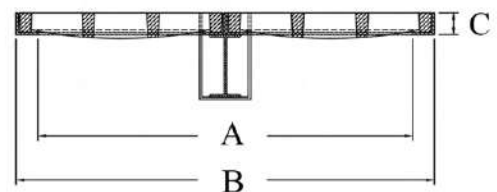
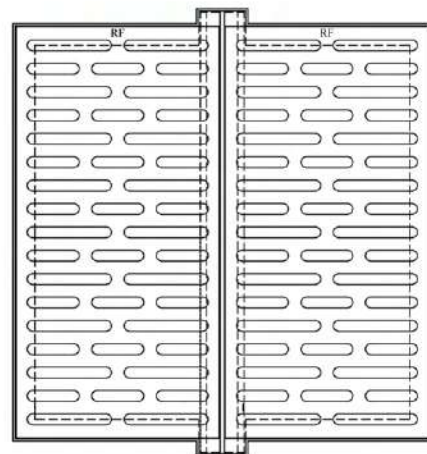

Product Code	Clear Opening A (mm)	Over Base B (mm)	Depth C (mm)	Loading (TONS)	Specifications
MC - 120 X 120 DI G2 M40 HD	1200 X 1200	1340 X 1340	70	40	BS - EN 124



Heavy Duty Grey Cast Iron Multiple Grates with Mild Steel Angle Frames

Features:-

- Galvanized Steel Frames
- Removable "T" Bar and "I" Beam
- Beam Housing Box
- Angle Frame 70 X 70 X 7mm

Options:-

- Black Epoxy Coated Frame

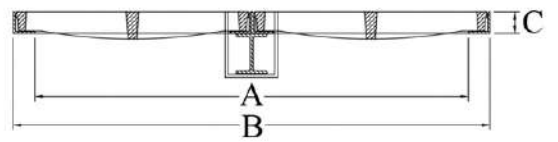
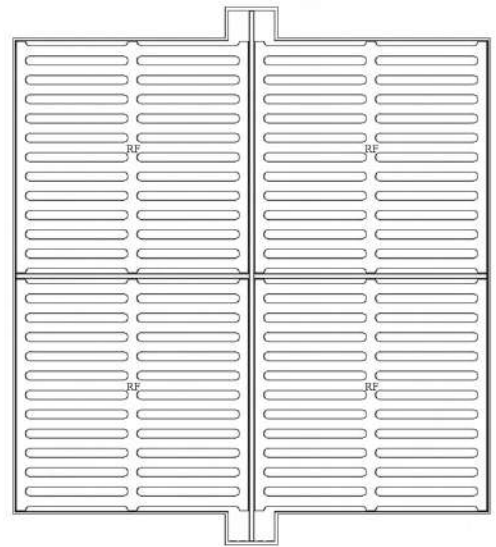

Product Code	Clear Opening A (mm)	Over Base B (mm)	Depth C (mm)	Loading (TONS)	Specifications
MC - 140 X 140 G 4 (HD)	1400 X 1400	1540 X 1540	70	40	B S - E N 124

Heavy Duty Grey Cast Iron Multiple Grates with Mild Steel Angle Frames

Features:-

- Galvanized Steel Frames
- Removable "T" Bar and "I" Beam
- Beam Housing Box
- Angle Frame 70 X 70 X 7mm

Options:-

- Black Epoxy Coated Frame

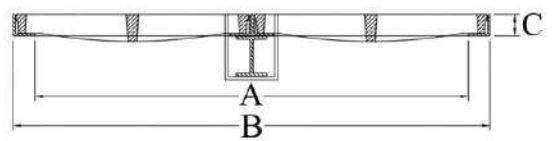
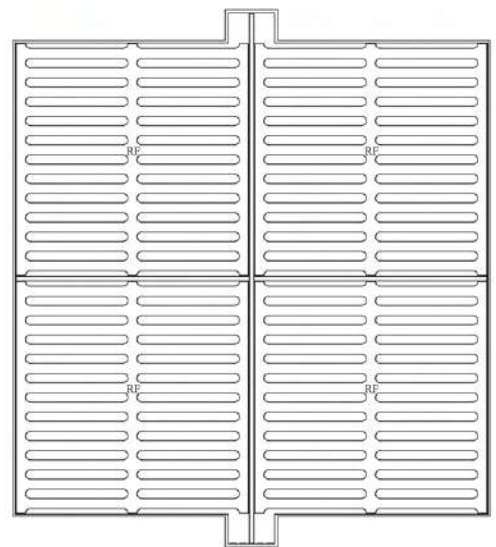

Product Code	Clear Opening A (mm)	Over Base B (mm)	Depth C (mm)	Loading (TONS)	Specifications
MC - 150 X 150 G 4 (HD)	1500 X 1500	1640 X 1640	70	40	B S - E N 124

**Heavy Duty Ductile Cast Iron (Class C 250)
Grates with Mild Steel Angle Frame**

Features:-

- Galvanized Steel Frame
- Removable "T" Bar and "I" Beam
- Beam Housing Box
- Angle Frame 80 X 80 X 8mm
- Slow Moving Traffic Only

Options:-

- Black Epoxy Coated Frame

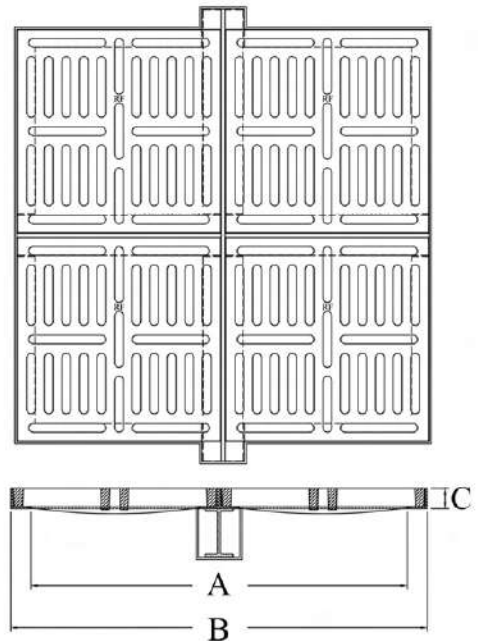

Product Code	Clear Opening A (mm)	Over Base B (mm)	Depth C (mm)	Loading (TONS)	Specifications
MC - 150 X 150 DI G4 HD	1500 X 1500	1660 X 1660	80 / 388	25	BS - EN 124

**Heavy Duty Grey Cast Iron Multiple Grates
with Mild Steel Angle Frame**

Features:-

- Black Epoxy Coated Frame
- Removable "T" Bar and "I" Beam
- Beam Housing Box
- Slow Moving Traffic Only

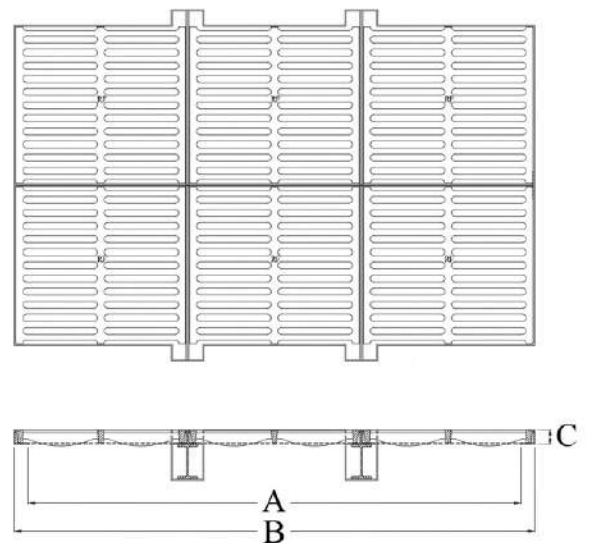

Product Code	Clear Opening A (mm)	Over Base B (mm)	Depth C (mm)	Loading (TONS)	Specifications
MC - 160 X 137 G 6 (HD)	1600 X 1370	1760 X 1530	80	40	BS - EN 124
MC - 200 X 150 G 6 (HD)	2000 X 1500	2160 X 1660	80	40	BS - EN 124
MC - 260 X 160 G 6 (HD)	2460 X 1460	2600 X 1600	70	40	BS - EN 124
MC - 250 X 150 G 6 (HD)	2500 X 1500	2640 X 1640	70	40	BS - EN 124
MC - 300 X 175 G 6 (HD)	3000 X 1750	3140 X 1890	70	40	BS - EN 124



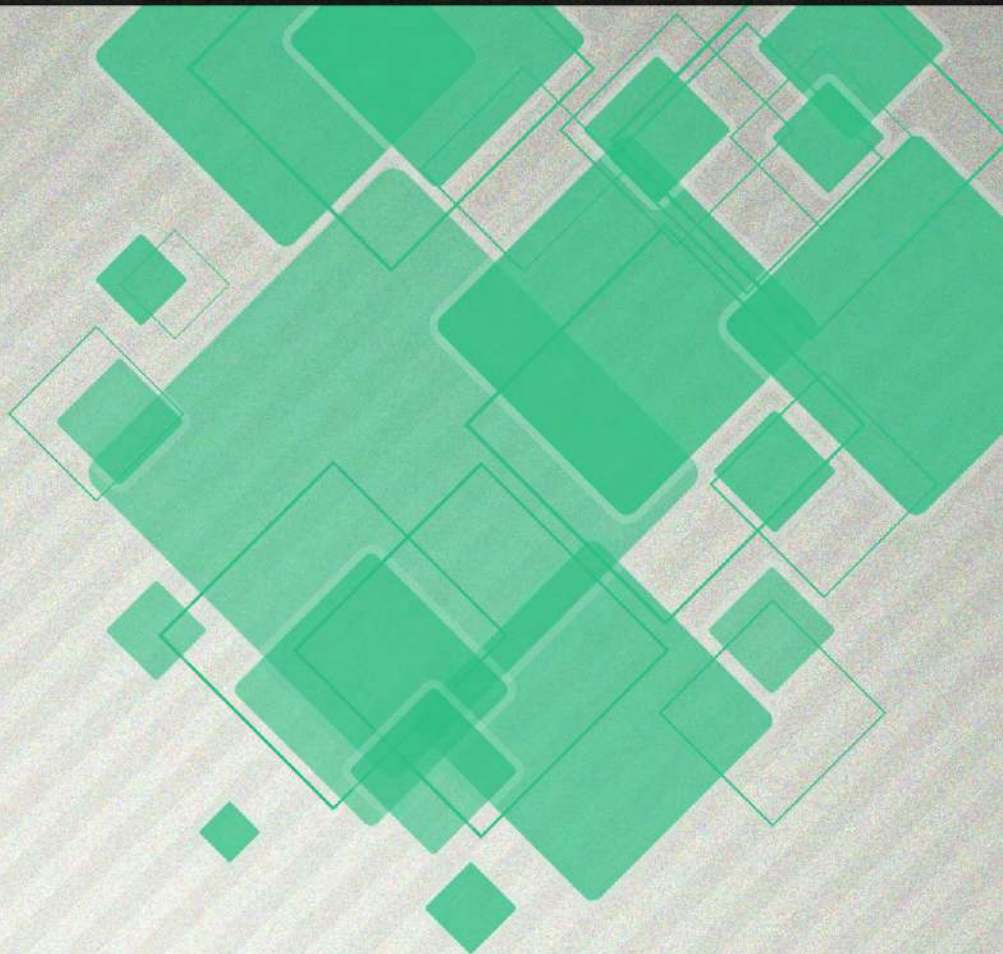

CHANNEL GRATINGS

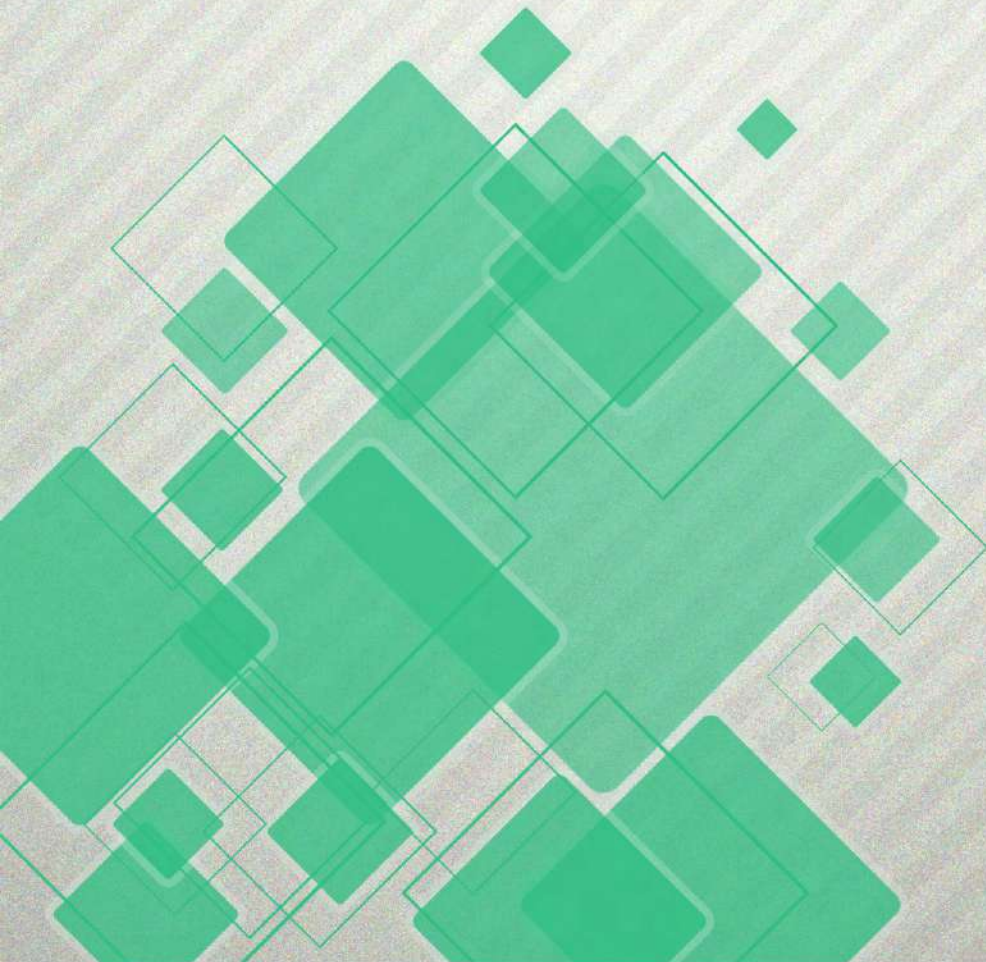
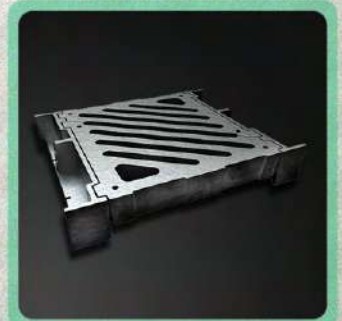



Ductile Cast Iron Grate

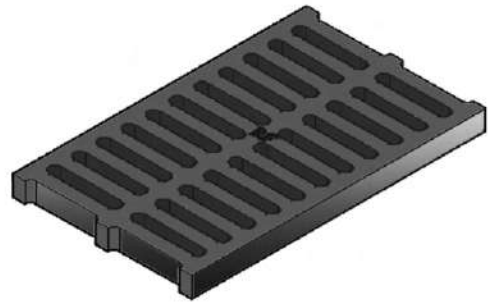

Ductile Cast Iron Grate

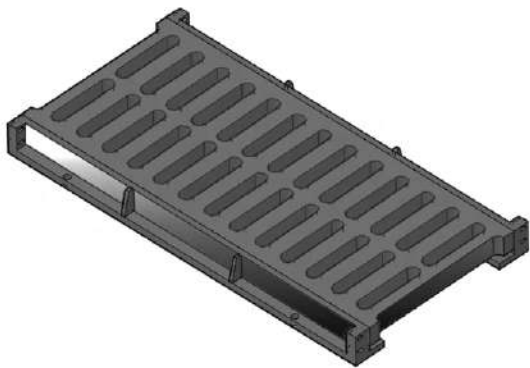

**Grey Cast Iron Grate
with Side Bar**

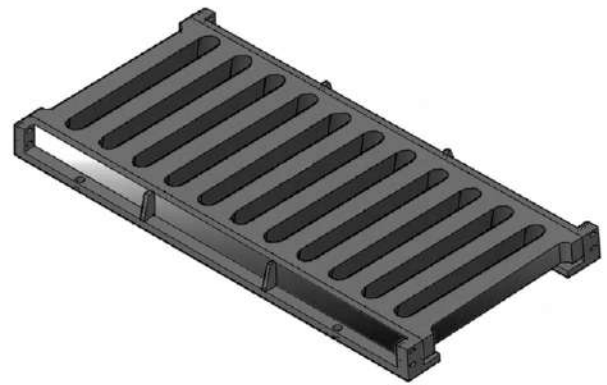

**Grey Cast Iron Grate
with Side Bar**



**Ductile Cast Iron Grate
with Side Bar**



**Ductile Cast Iron Grate
with Side Bar**



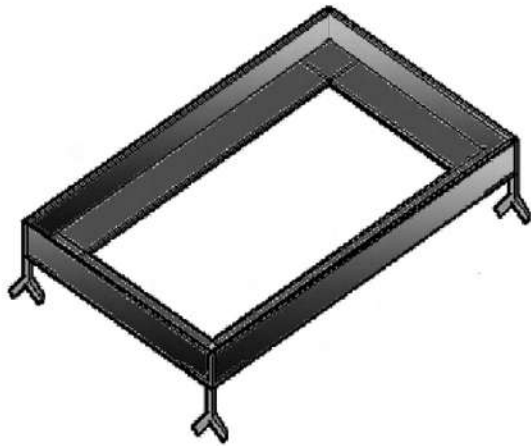

Mild Steel Full Supported Frame



Channel Grate with Mild Steel Frame



Channel Grate with Mild Steel Frame



Mild Steel Frame by Lenier Meter

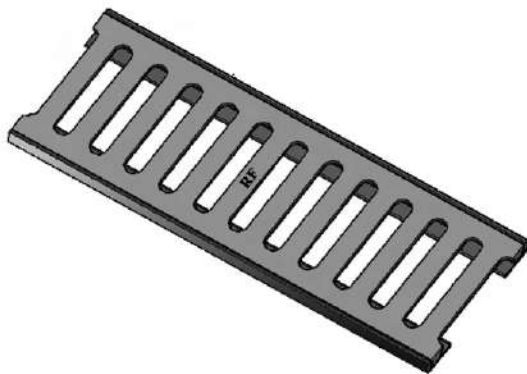

Channel Grate with Mild Steel Frame by Lenier Meter

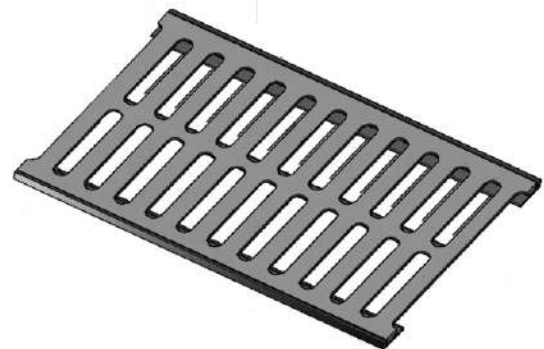

Channel Grate with Mild Steel Frame by Lenier Meter

Heavy Duty Grey Cast Iron Channel Gratings and Side Frames

Features:-

- Holes for Anchoring
- Standard Grate Length - 750mm
- Standard Grate Depth - 54mm

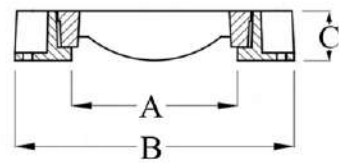
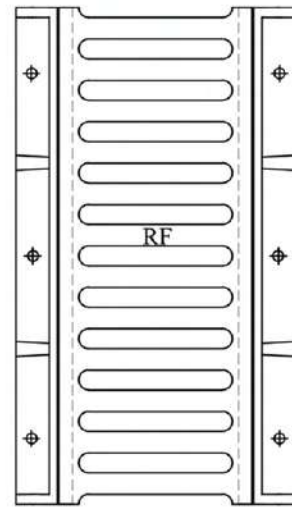

Product Code	Clear Opening A (mm)	Over Base B (mm)	Depth C (mm)	Loading (TONS)	Specifications
MC - 500 AR4 (HD)	150	750 X 320	75	40	BS - EN 124

Extra Heavy Duty Ductile Cast Iron Channel Grating and Side Frames

Features:-

- 12mm Dia Holes for Anchor Bolt
- Standard Grate Length 750mm
- Standard Grate Depth 54mm

Options:-

- Mild Steel Angle Frame 60 X 60 X 6mm

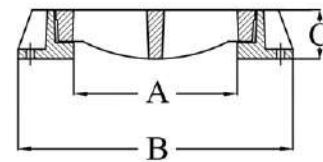
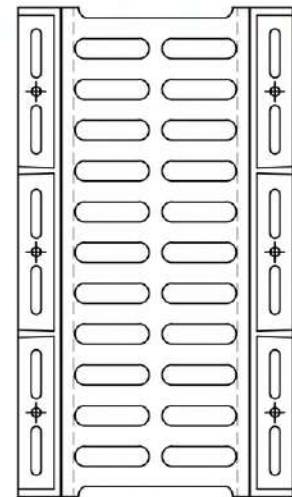

Product Code	Clear Opening A (mm)	Over Base B (mm)	Depth C (mm)	Loading (TONS)	Specifications
MC - 516 E DI (HD)	150	750 X 320	75	60	BS - EN 124



Extra Heavy Duty Ductile Cast Iron Channel Grating and Side Frame

AIRPORT DESIGN - FRAME AND COVER

Features:-

- 12mm Dia Holes for Anchor Bolts
- Standard Grate Length 750mm
- Standard Grate Depth 54mm

Options:-

- Mild Steel Angle
- Frame 60 X 60 X 6mm

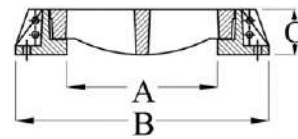
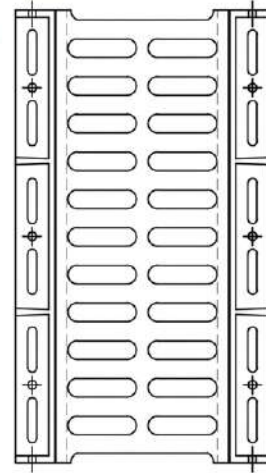

Product Code	Clear Opening A (mm)	Over Base B (mm)	Depth C (mm)	Loading (TONS)	Specifications
MC - 516 R2 DI (HD)	150	750 X 320	75	90	BS - EN 124
MC - 516 R2 DI (HD)	150	750 X 320	75	60	BS - EN 124

Heavy Duty Grey Cast Iron Channel Grates and Frames

Features:-

- Grating Secured to the Side Frame
- Foundation Bolt Slots

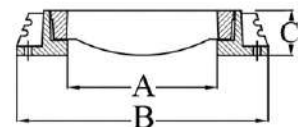
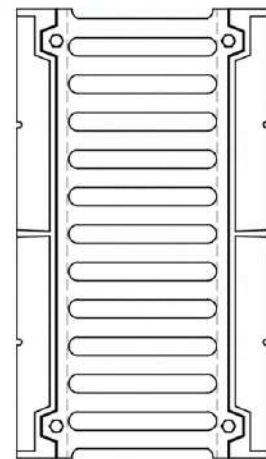

Product Code	Clear Opening A (mm)	Over Base B (mm)	Depth C (mm)	Loading (TONS)	Specifications
MC - 490 G (HD)	150	750 X 330	75	40	BS - EN 124

Light, Medium, Heavy Duty and Straight Bars, Grey Cast Iron Channel Gratings and Side Frames

Features:-

- Holes for Anchoring
- Standard Grate Length - 750mm
- Standard Grate Depth - 54mm

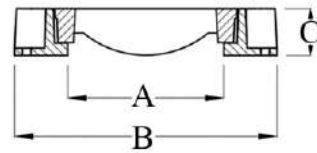
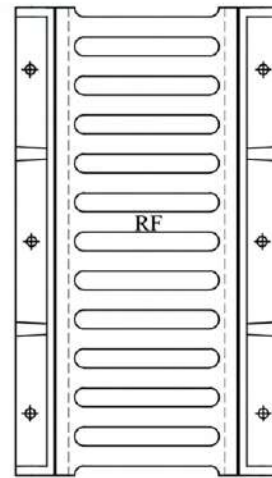

Product Code	Clear Opening A (mm)	Over Base B (mm)	Depth C (mm)	Loading (TONS)	Specifications
MC - 500 (LD)	250	750 X 420	75	1.5	BS - EN 124
MC - 500 (MD)	250	750 X 420	75	12.5	BS - EN 124
MC - 500 (HD)	250	750 X 420	75	40	BS - EN 124

Extra Heavy Duty Ductile Cast Iron Channel Grating and Side Frames

Features:-

- 12mm Dia Holes for Anchor Bolt
- Standard Grate Length 750mm
- Standard Grate Depth 54mm

Options:-

- Mild Steel Angle Frame 60 X 60 X 6mm

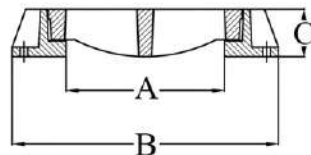
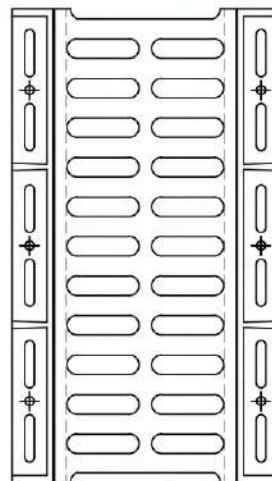

Product Code	Clear Opening A (mm)	Over Base B (mm)	Depth C (mm)	Loading (TONS)	Specifications
MC - 500 E DI (HD)	250	750 X 420	75	60	BS - EN 124



Medium and Heavy Duty, Straight Bars Ductile Cast Iron Channel Gratings

Features:-

- Standard Grate Length 750mm
- Grate Depth 54mm
- 12mm Dia Holes for Anchor Bolt

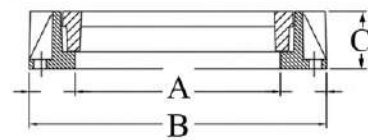
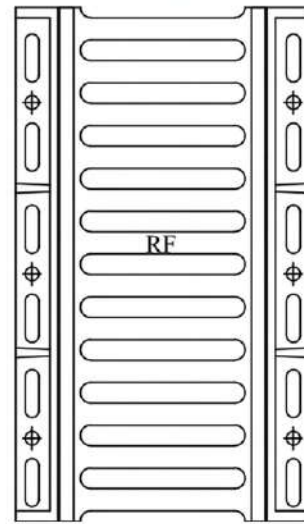

Product Code	Clear Opening A (mm)	Over Base B (mm)	Depth C (mm)	Loading (TONS)	Specifications
MC - 500 R6 DI (MD)	265	750 X 385	75	12.5	BS - EN 124
MC - 500 R6 DI (HD)	265	750 X 385	75	40	BS - EN 124

Light, Medium, Heavy Duty and Straight Bars Grey Cast Iron Channel Gratings and Side Frames

Features:-

- Holes for Anchoring
- Standard Grate Length - 750mm
- Standard Grate Depth - 54mm

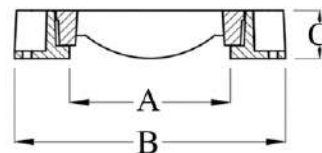
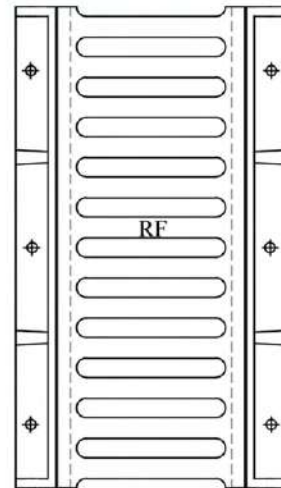

Product Code	Clear Opening A (mm)	Over Base B (mm)	Depth C (mm)	Loading (TONS)	Specifications
MC - 500 R1 (LD)	300	750 X 470	75	1.5	BS - EN 124
MC - 500 R1 (MD)	300	750 X 470	75	12.5	BS - EN 124
MC - 500 R1 (HD)	300	750 X 470	75	40	BS - EN 124

Heavy Duty and Extra Heavy Duty Ductile Cast Iron Channel Grating and Side Frames

Features:-

- Standard Grate Width 340mm
- Standard Grate Length 750mm
- 12mm Dia Holes for Frame Anchor to Concrete

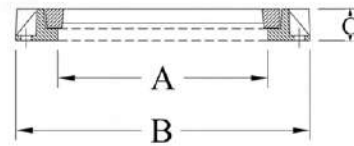
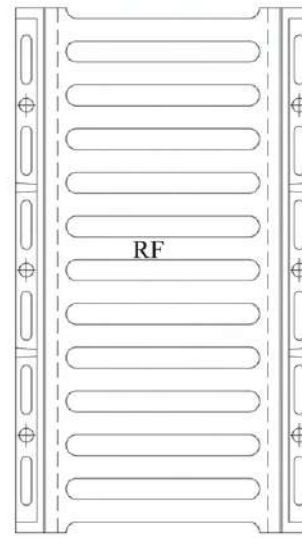

Product Code	Clear Opening A (mm)	Over Base B (mm)	Depth C (mm)	Loading (TONS)	Specifications
MC - 500 R2 M D I (HD)	300	420	45	40	BS - EN 124
MC - 500 R2 D I (HD)	300	420	75	90	BS - EN 124

Heavy Duty and Extra Heavy Duty Ductile Cast Iron Channel Grating and Side Frames

Features:-

- 12mm Dia Holes for Anchor Bolt
- Standard Grate Length 750mm
- Standard Grate Depth 54mm

Options:-

- Mild Steel Angle Frame 60 X 60 X 6mm

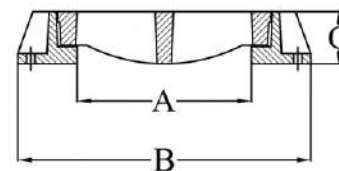
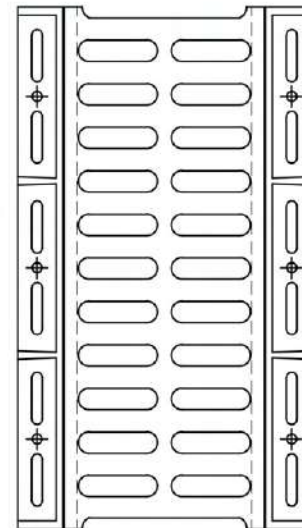

Product Code	Clear Opening A (mm)	Over Base B (mm)	Depth C (mm)	Loading (TONS)	Specifications
MC - 500 R1 DI (HD)	300	750 X 470	75	40	BS - EN 124
MC - 500 E DI (HD)	300	750 X 470	75	60	BS - EN 124



Light, Medium, Heavy Duty and Straight Bars, Grey Cast Iron Channel Gratings and Side Frames

Features:-

- Holes for Anchoring
- Standard Grate Length - 750mm
- Standard Grate Depth - 54mm

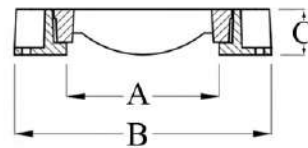
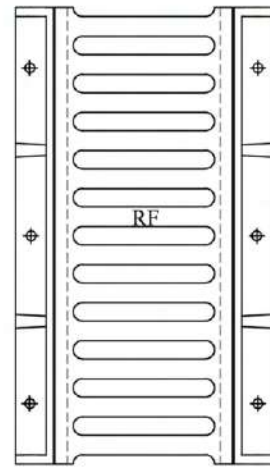

Product Code	Clear Opening A (mm)	Over Base B (mm)	Depth C (mm)	Loading (TONS)	Specifications
MC - 501 (LD)	350	750 X 520	75	1.5	BS - EN 124
MC - 501 (MD)	350	750 X 520	75	12.5	BS - EN 124
MC - 501 (HD)	350	750 X 520	75	40	BS - EN 124

Medium and Heavy Duty Ductile Cast Iron Grates and Side Frames

Features:-

- Standard Grate Depth 54mm
- Standard Grate Length 750mm
- Slots for Anchor Bolt

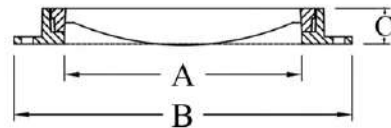
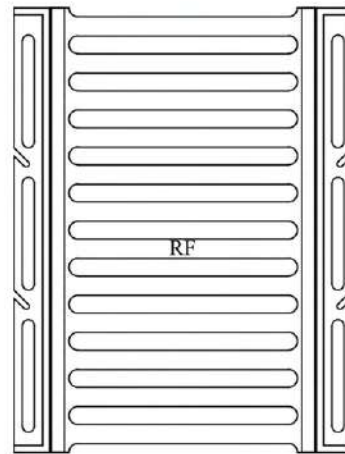

Product Code	Clear Opening A (mm)	Over Base B (mm)	Depth C (mm)	Loading (TONS)	Specifications
MC - 510 R3 DI (MD)	400	540	60	12.5	BS - EN 124
MC - 510 R3 DI (HD)	400	540	60	40	BS - EN 124

Light,Medium,Heavy Duty and Straight Bars, Grey Cast Iron
Channel Gratings and Sides

Features:-

- 12mm Dia Holes for Frames Anchor to Concrete
- Standred Grate Length - 750mm

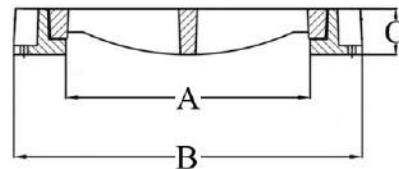
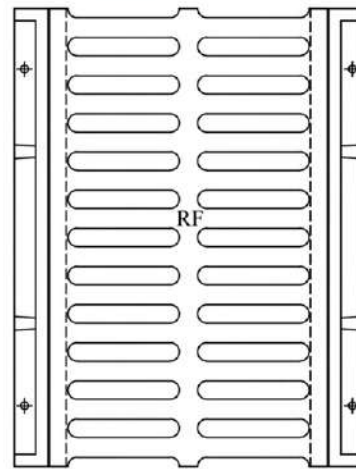

Product Code	Clear Opening A (mm)	Over Base B (mm)	Depth C (mm)	Loading (TONS)	Specifications
MC - 510 (LD)	400	750 X 570	75	1.5	BS - EN 124
MC - 510 (MD)	400	750 X 570	75	12.5	BS - EN 124
MC - 510 (HD)	400	750 X 570	75	40	BS - EN 124

Light,Medium,Heavy Duty and Straight Bars, Grey Cast Iron
Channel Gratings and Sides

Features:-

- 12mm Dia Holes for Frames Anchor to Concrete
- Standred Grate Length - 750mm
- Standred Grate Depth - 54mm (Excluding 5II AR 3)

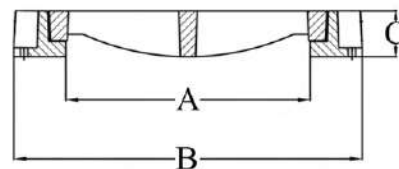
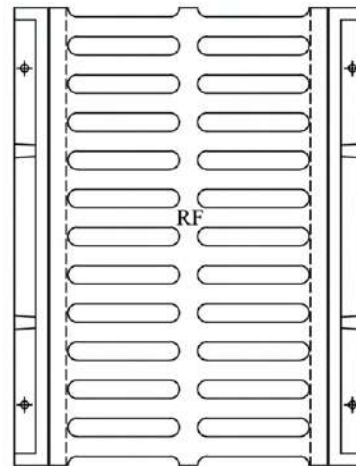

Product Code	Clear Opening A (mm)	Over Base B (mm)	Depth C (mm)	Loading (TONS)	Specifications
MC - 511 (LD)	500	750 X 670	75	1.5	BS - EN 124
MC - 511 (MD)	500	750 X 670	75	12.5	BS - EN 124
MC - 511 (HD)	500	750 X 670	75	40	BS - EN 124
MC - 511 AR3 (MD)	500	750 X 670	50	12.5	BS - EN 124



Light, Medium, Heavy Duty and Straight Bars, Grey Cast Iron

Channel Gratings and Side

Features:-

- 12mm Dia Holes for Frames Anchor to Concrete
- Standard Grate Length - 750mm

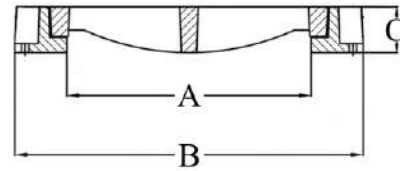
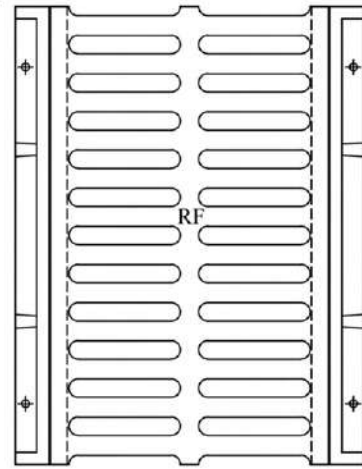

Product Code	Clear Opening A (mm)	Over Base B (mm)	Depth C (mm)	Loading (TONS)	Specifications
MC - 512 (LD)	600	750 X 770	75	1.5	BS - EN 124
MC - 512 (MD)	600	750 X 770	75	12.5	BS - EN 124
MC - 512 (HD)	600	750 X 770	75	40	BS - EN 124

Heavy Duty Grey Cast Iron Grates and Frames

Features:-

- Triangular Grating
- Grating Secured to the Side Frame
- Foundation Bolt Slots

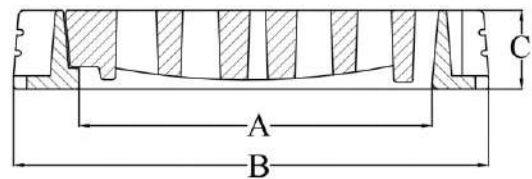
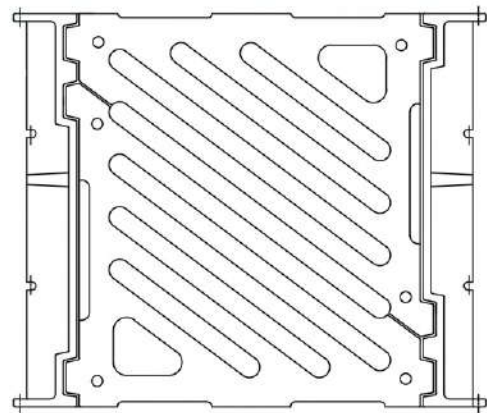

Product Code	Clear Opening A (mm)	Over Base B (mm)	Depth C (mm)	Loading (TONS)	Specifications
MC - 900 G (HD)	600	900 X 755	130	40	BS - EN 129

Heavy Duty Ductile Cast Iron Grates and Frames

Features:-

- Double Triangular and Hinge Grates

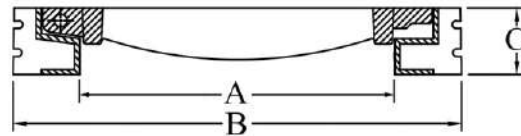
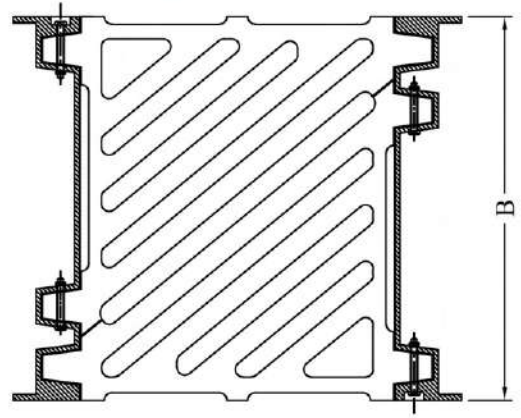

Product Code	Clear Opening A (mm)	Over Base B (mm)	Depth C (mm)	Loading (TONS)	Specifications
MC - 901 DI G (HD)	615Sq	875 X 750	130	40	BS - EN 124

Heavy Duty Grey Cast Iron Grates and Side Frames

Features:-

- Standard Grate Length 500mm
- Standard Grate Depth 54mm

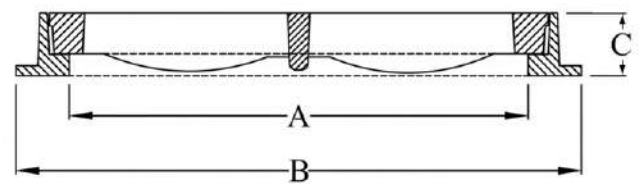
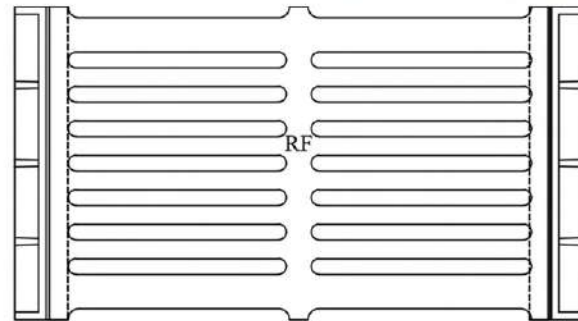

Product Code	Clear Opening A (mm)	Over Base B (mm)	Depth C (mm)	Loading (TONS)	Specifications
MC - 900 G5 (HD)	800	960	75	40	BS - EN



Heavy Duty Ductile Cast Iron Channel Gratings and Side Frames

Features:-

- Standard Grate Width 225mm
- Standard Grate Length 750mm

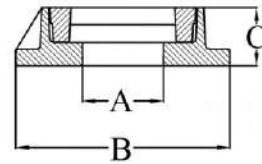
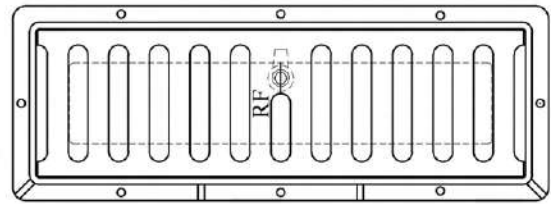

Product Code	Clear Opening A (mm)	Over Base B (mm)	Depth C (mm)	Loading (TONS)	Specifications
MC - 500 F D I (HD)	125 X 651	826 X 300	90	40	BS - EN 124

Light, Medium and Heavy Duty Grey Cast Iron channel Grates with Mild Steel Angle Frame

Features:-

- Steel Angle Frame 60 X 60 X 6mm
- Standard Grate Length - 750mm
- Standard Grate Depth - 54mm
- Provided with Fish Tail
- Total Depth 60mm (Including Steel Frame)

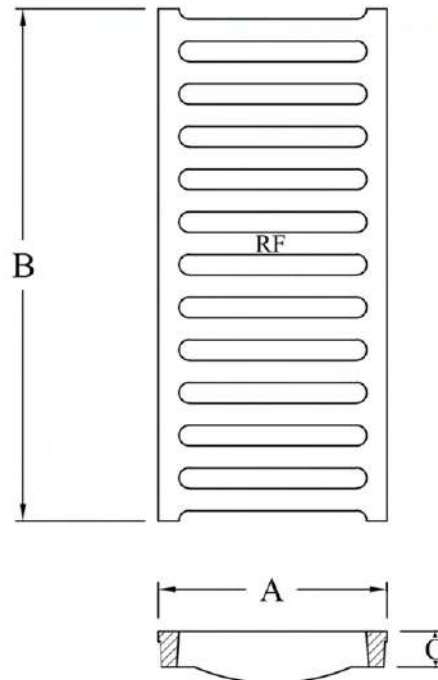

Product Code	Grate Width A (mm)	Grate Length B (mm)	Grate Depth C (mm)	Loading (TONS)	Specifications
MC - 515 (LD)	150	750	54	1.5	BS - EN 124
MC - 515 (MD)	150	750	54	12.5	BS - EN 124
MC - 515 (HD)	150	750	54	40	BS - EN 124

Light, Medium and Heavy Duty Grey Cast Iron channel Grates with Mild Steel Angle Frame

Features:-

- Steel Angle Frame 60 X 60 X 6mm
- Standard Grate Length - 750mm
- Standard Grate Depth - 54mm
- Provided with Fish Tail
- Total Depth 60mm (Including Steel Frame)

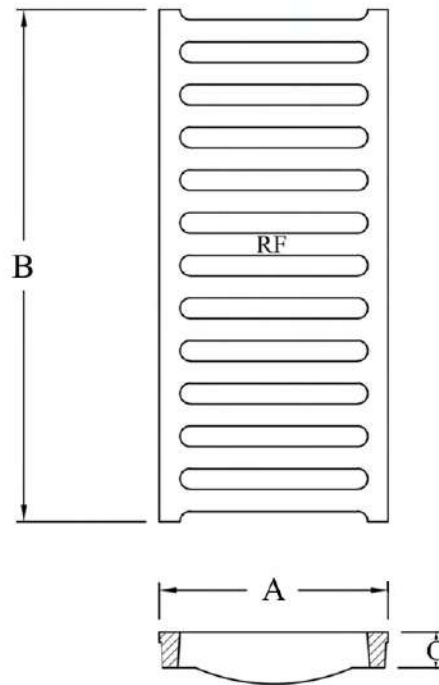

Product Code	Grate Width A (mm)	Grate Length B (mm)	Grate Depth C (mm)	Loading (TONS)	Specifications
MC - 516 (LD)	200	750	54	1.5	BS - EN 124
MC - 516 (MD)	200	750	54	12.5	BS - EN 124
MC - 516 (HD)	200	750	54	40	BS - EN 124

Light Duty Grey Cast Iron Channel Gratings with Mild Steel Angle Frame

Features:-

- Steel Angle 60 X 60 X 6mm
- Standard Grate Length 750mm
- Standard Grate Depth 54mm
- Provided with Fish Tail
- Total Depth = 60mm (Including Steel Frame)

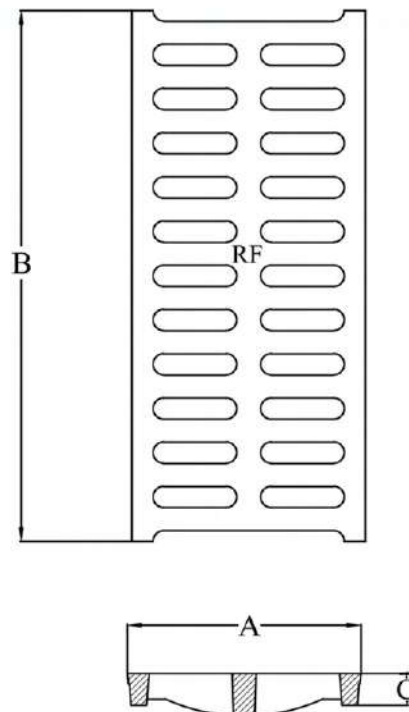

Product Code	Grate Width A (mm)	Grate Length B (mm)	Grate Depth C (mm)	Loading (TONS)	Specifications
MC - 515 A (LD)	200	750	54	1.5	BS - EN 124

Light, Medium and Heavy Duty Grey Cast Iron channel Grates with Mild Steel Angle Frame

Features:-

- Steel Angle Frame 60 X 60 X 6mm
- Standard Grate Length - 750mm
- Standard Grate Depth - 54mm
- Provided with Fish Tail
- Total Depth 60mm (Including Steel Frame)

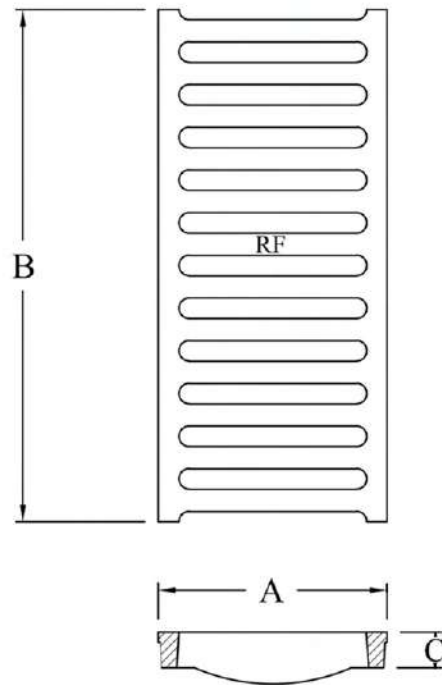

Product Code	Grate Width A (mm)	Grate Length B (mm)	Grate Depth C (mm)	Loading (TONS)	Specifications
MC - 517 (LD)	250	750	54	1.5	BS - EN 124
MC - 517 (MD)	250	750	54	12.5	BS - EN 124
MC - 517 (HD)	250	750	54	40	BS - EN 124

Light Duty Grey Cast Iron Channel Gratings with Mild Steel Angle Frame

Features:-

- Steel Angle 60 X 60 X 6mm
- Standard Grate Length 750mm
- Standard Grate Depth 54mm
- Provided with Fish Tail
- Total Depth = 60mm (Including Steel Frame)

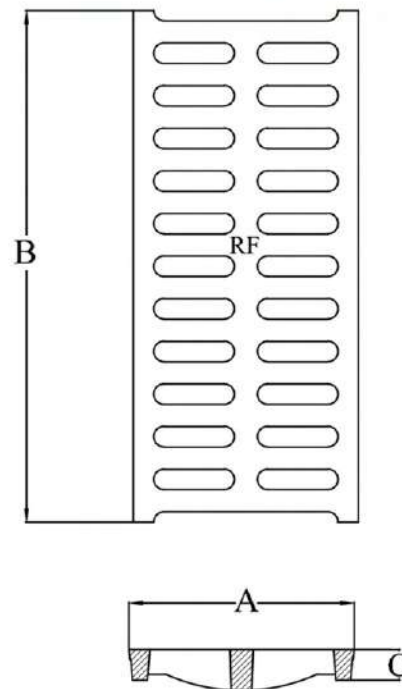

Product Code	Grate Width A (mm)	Grate Length B (mm)	Grate Depth C (mm)	Loading (TONS)	Specifications
MC - 515 B (LD)	250	750	54	1.5	BS - EN 124

Light Duty Grey Cast Iron Channel Gratings with Mild Steel Angle Frame

Features:-

- Steel Angle 60 X 60 X 6mm
- Standard Grate Length 750mm
- Standard Grate Depth 54mm
- Provided with Fish Tail
- Total Depth = 60mm (Including Steel Frame)

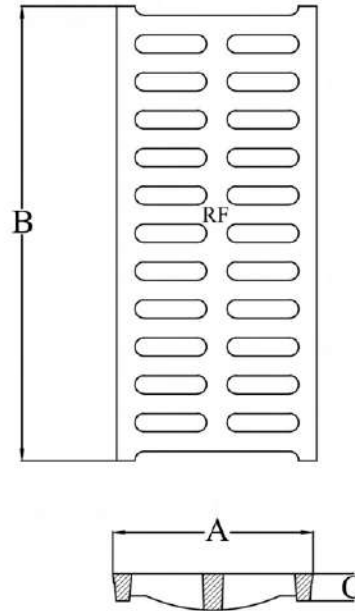

Product Code	Grate Width A (mm)	Grate Length B (mm)	Grate Depth C (mm)	Loading (TONS)	Specifications
MC - 515 C (LD)	300	750	54	1.5	BS - EN 124

Light, Medium and Heavy Duty Grey Cast Iron channel Grates with Mild Steel Angle Frame

Features:-

- Steel Angle 60 X 60 X 6mm
- Standard Grate Length 750mm
- Standard Grate Depth 54mm
- Provided With Fish Tail
- Total Depth = 60mm (Including Steel Frame)

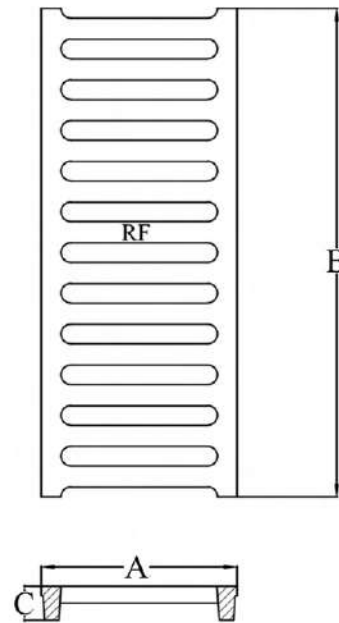

Product Code	Grate Width A (mm)	Grate Length B (mm)	Grate Depth C (mm)	Loading (TONS)	Specifications
MC - 520 (LD)	300	750	54	1.5	BS - EN 124
MC - 520 (MD)	300	750	54	12.5	BS - EN 124
MC - 520 (HD)	300	750	54	40	BS - EN 124



Heavy Duty Ductile Cast Iron Channel Gratings with Mild Steel Angle Frame

Features:-

- Grate Depth 45mm
- Standard Grate Length 750mm
- Grate Width 335mm
- Black Epoxy Frames
- Angle Frame Used 50 X 50 X 5mm
- Total Depth = 50mm (Including Steel Frame)

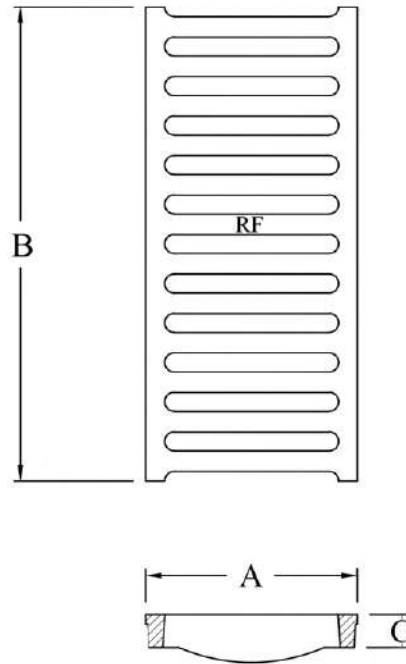

Product Code	Grate Width A (mm)	Grate Length B (mm)	Grate Depth C (mm)	Loading (TONS)	Specifications
MC - 517 RD 50 (HD)	335	750	45	40	BS - E N 124

Light Duty Grey Cast Iron Channel Gratings with Mild Steel Angle Frame

Features:-

- Steel Angle 60 X 60 X 6mm
- Standard Grate Length 750mm
- Standard Grate Depth 54mm
- Provided with Fish Tail
- Total Depth = 60mm (Including Steel Frame)

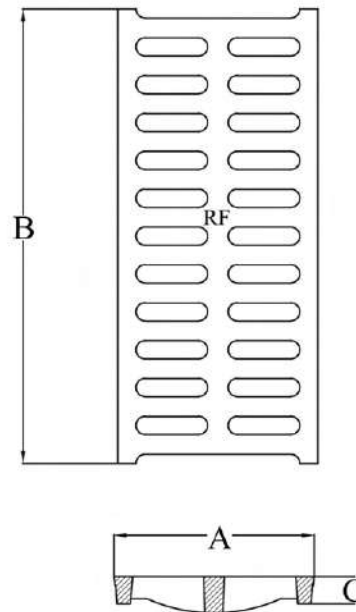

Product Code	Grate Width A (mm)	Grate Length B (mm)	Grate Depth C (mm)	Loading (TONS)	Specifications
MC - 515 D (LD)	350	750	54	1.5	BS - E N 124

Light, Medium and Heavy Duty Grey Cast Iron channel Grates with Mild Steel Angle Frame

Features:-

- Steel Angle 60 X 60 X 6mm
- Standard Grate Length 750mm
- Standard Grate Depth 54mm
- Provided With Fish Tail
- Total Depth = 60mm (Including Steel Frame)

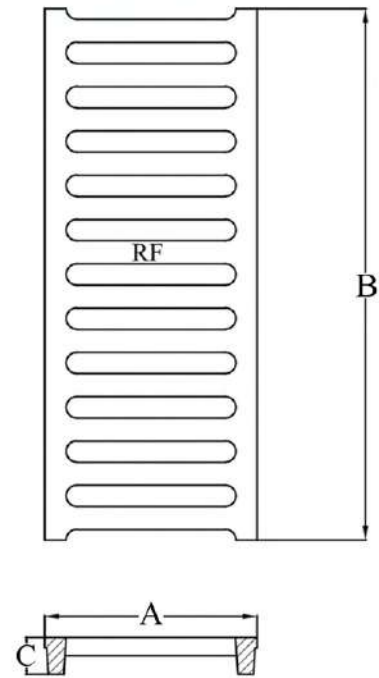

Product Code	Grate Width A (mm)	Grate Length B (mm)	Grate Depth C (mm)	Loading (TONS)	Specifications
MC - 521 (LD)	400	750	54	1.5	BS - EN 124
MC - 521 (MD)	400	750	54	12.5	BS - EN 124
MC - 521 (HD)	400	750	54	40	BS - EN 124

Light, Medium and Heavy Duty Grey Cast Iron channel Grates with Mild Steel Angle Frame

Features:-

- Steel Angle 60 X 60 X 6mm
- Standard Grate Length 750mm
- Standard Grate Depth 54mm
- Provided With Fish Tail
- Total Depth = 60mm (Including Steel Frame)

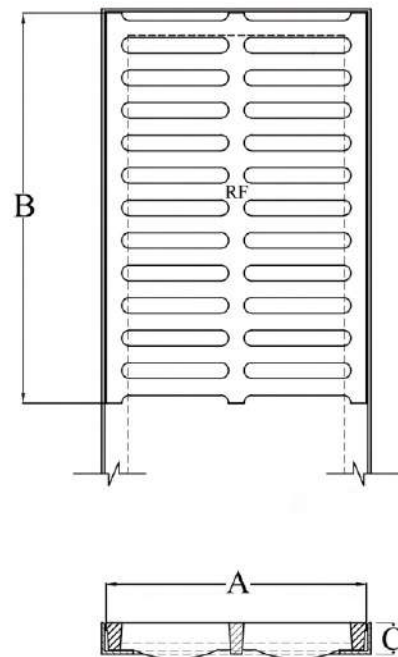

Product Code	Grate Width A (mm)	Grate Length B (mm)	Grate Depth C (mm)	Loading (TONS)	Specifications
MC - 525 (LD)	500	750	54	1.5	BS - EN 124
MC - 525 (MD)	500	750	54	12.5	BS - EN 124
MC - 525 (HD)	500	750	54	40	BS - EN 124

Light, Medium and Heavy Duty Grey Cast Iron channel Grates with Mild Steel Angle Frame

Features:-

- Steel Angle 60 X 60 X 6mm
- Standard Grate Length 750mm
- Standard Grate Depth 54mm
- Provided With Fish Tail
- Total Depth = 60mm (Including Steel Frame)

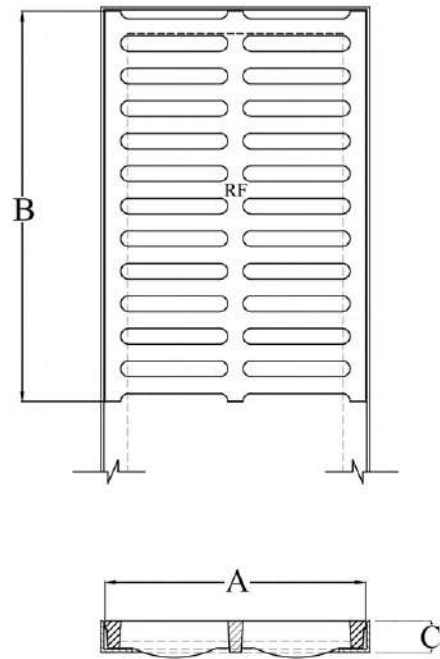

Product Code	Grate Width A (mm)	Grate Length B (mm)	Grate Depth C (mm)	Loading (TONS)	Specifications
MC - 526 (LD)	600	750	54	1.5	BS - EN 124
MC - 526 (MD)	600	750	54	12.5	BS - EN 124
MC - 526 (HD)	600	750	54	40	BS - EN 124



TREE GRATINGS

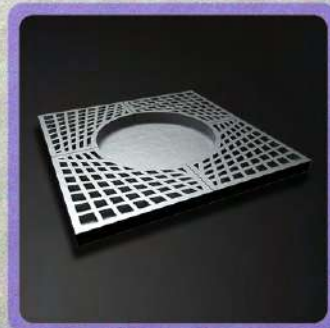
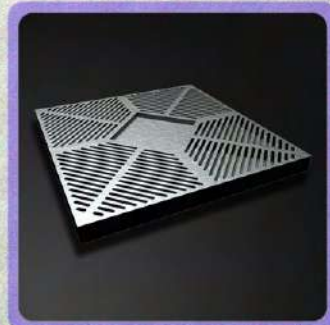

Grey Cast Iron Square Tree Gratings with Cast Iron Frame

Features:-

- Grate in Two Pieces
- Grate Bolted Together

Options:-

- Opening for Light Fixtures

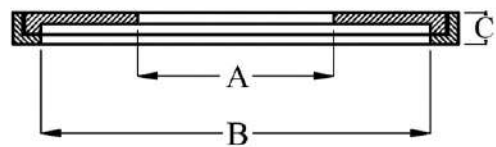
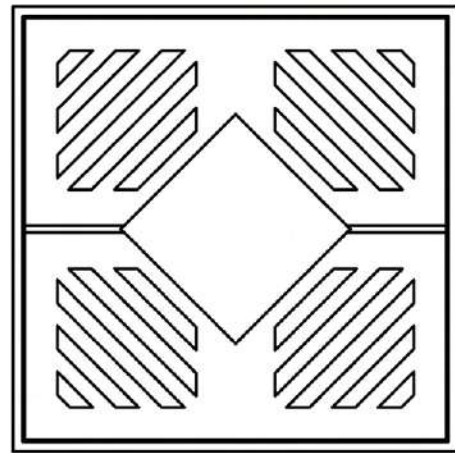

Product Code	Tree Opening A (mm)	Overall Size B (mm)	Grate Depth C (mm)	Specifications
TG - 570	320Sq	870Sq	50	B S - EN 124

Grey Cast Iron Square Tree Gratings

Features:-

- Grate in Two Pieces
- Grate Bolted Together
- Opening for Light Fixtures

Options:-

- Galvanized Mild Steel Angle Frame

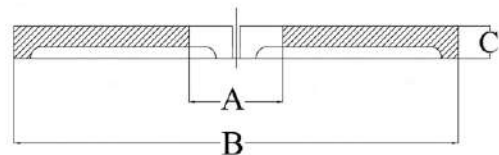
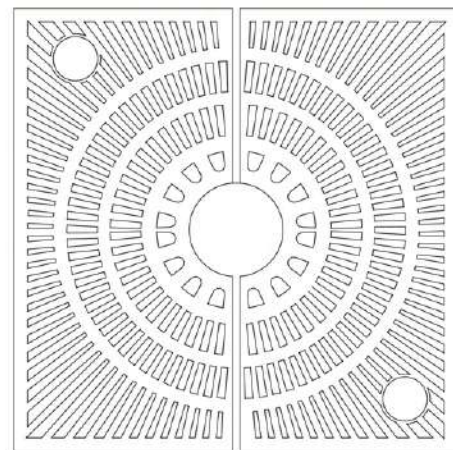

Product Code	Tree Opening A (mm)	Grate Overall Size B (mm)	Grate Depth C (mm)	Specifications
TG - 555	350Ø	1320Sq	63	B S - EN 124



Grey Cast Iron Square Tree Gratings

Features:-

- Grate in Two Pieces
- Grate Bolted Together
- Hot Dip Galvanized Steel Frame

Options:-

- Opening for Light Fixture

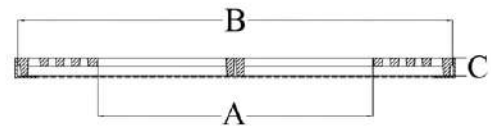
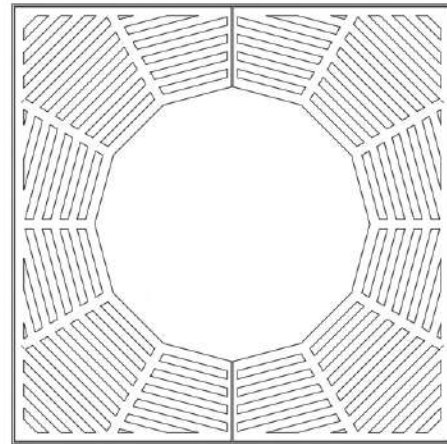
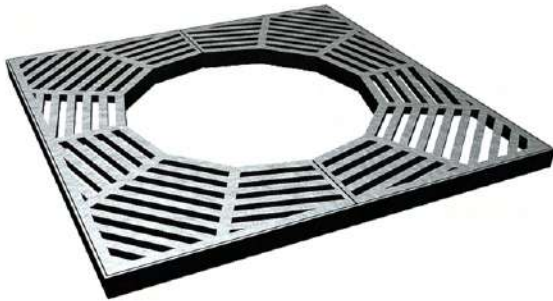

Product Code	Tree Opening A (mm)	Grate Overall Size B (mm)	Grate Depth C (mm)	Specifications
TG - 559 R 2	450Ø	1200Sq	63	B S - E N 124

Grey Cast Iron Square Tree Gratings

Features:-

- Grate in Two Pieces
- Grate Bolted Together

Options:-

- Galvanized Mild Steel Angle Frames
- Opening for Light Fixture

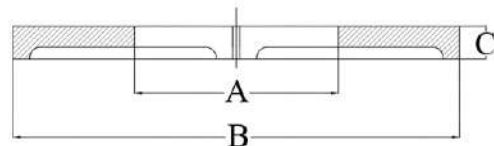
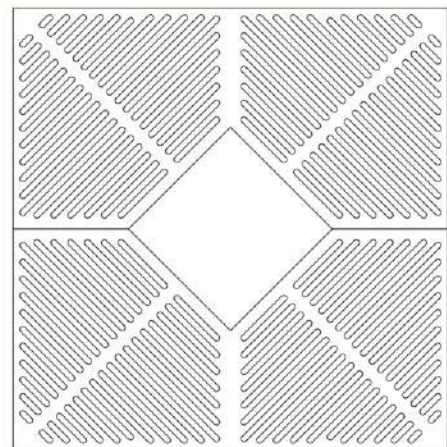

Product Code	Tree Opening A (mm)	Grate Overall Size B (mm)	Grate Depth C (mm)	Specifications
TG - 555 R 1	500Sq	1500Sq	50	B S - E N 124

Grey Cast Iron Square Tree Gratings

Features:-

- Grate in Four Pieces
- Grate Bolted Together
- Square Tree Opening

Options:-

- Hot Dip Galvanized / Black Epoxy Painted Frame
- 50 X 50 X 5mm with over
- Base = 1200 X 1200mm

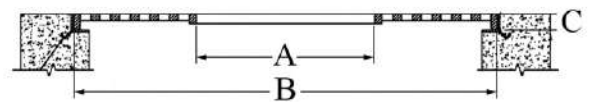
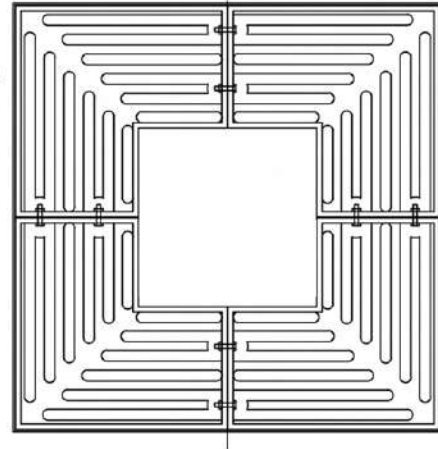

Product Code	Tree Opening A (mm)	Grate Size B (mm)	Grate Depth C (mm)
TG - 553 SQ / 50	500Sq	1200Sq	40

Grey Cast Iron Round Tree Gratings

Features:-

- Grate in Two Pieces
- Grate Bolted Together

Options:-

- Opening for Light Fixtures

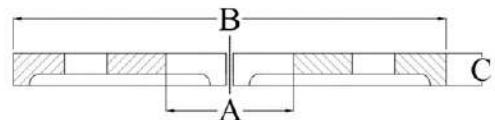
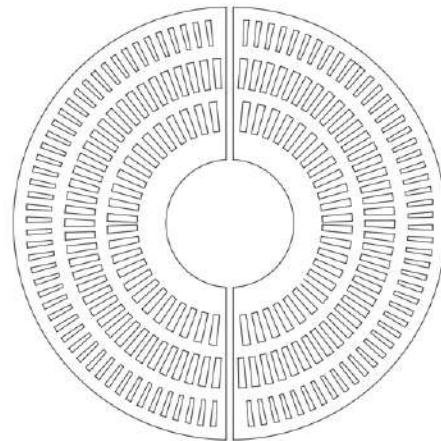

Product Code	Tree Opening A (mm)	Grate Overall Size B (mm)	Grate Depth C (mm)	Specifications
TG - 560 R 1	500Ø	1575Ø	30	BS - EN 124



Grey Cast Iron Square Tree Gratings

Features:-

- Grate in Two Pieces
- Grate Bolted Together
- Opening for Light Fixtures

Options:-

- Without Light Opening
- Mild Steel Support Frames

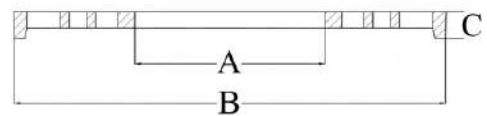
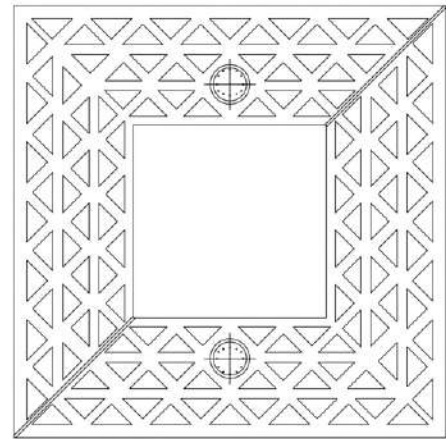
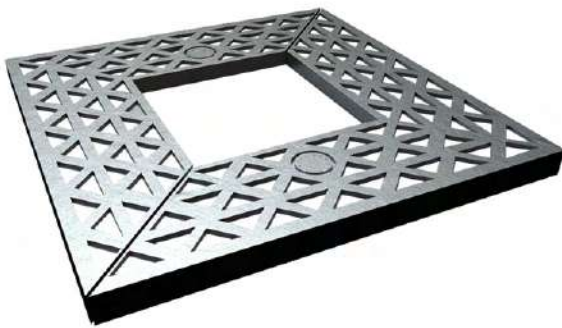

Product Code	Tree Opening A (mm)	Grate Overall Size B (mm)	Grate Depth C (mm)	Specifications
TG - 550 R 5	600Sq	1200Sq	30	B S - E N 124

Grey Cast Iron Square Tree Gratings

Features:-

- Grate in Two Pieces
- Grate Bolted Together
- Opening for Light Fixtures

Options:-

- Galvanized Mild Steel Angle Frame

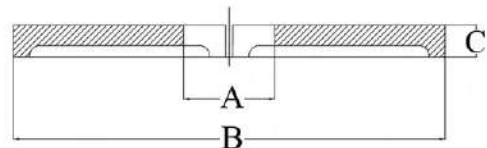
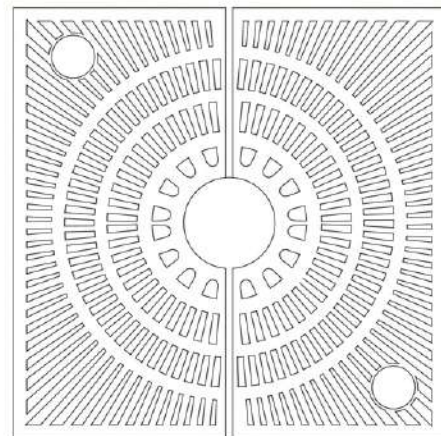

Product Code	Tree Opening A (mm)	Grate Overall Size B (mm)	Grate Depth C (mm)	Specifications
TG - 557 R 2	600Ø	2000Sq	45	B S - E N 124

Ductile Cast Iron Square Tree Gratings

Features:-

- Grate In Four Pieces
- Grate Bolted Together
- Without Light Opening

Options:-

- Opening for Light Fixture

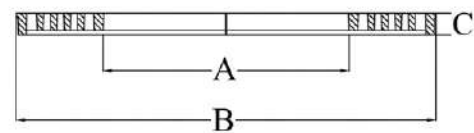
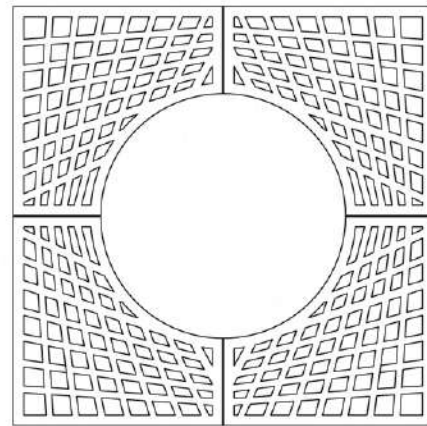

Product Code	Tree Opening A (mm)	Grate Overall Size B (mm)	Grate Depth C (mm)	Specifications
TG - 550 / 120 DI	700Ø	1200Sq	63	BS - EN 124

Grey Cast Iron Square Tree Gratings

Features:-

- Grate in Two Pieces
- Grate Bolted Together
- Opening for Light Fixtures

Options:-

- Without Light Opening
- Mild Steel Support Frames

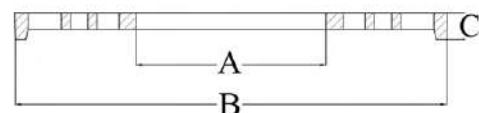
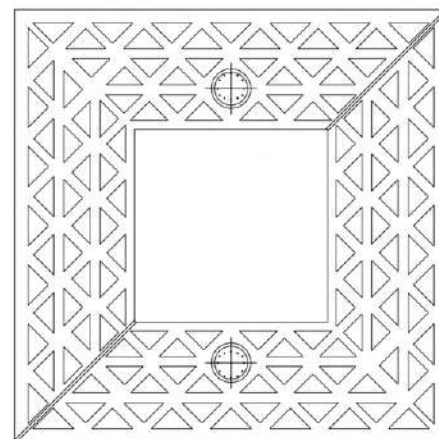
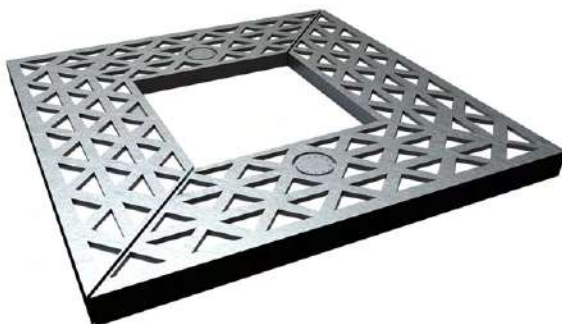

Product Code	Tree Opening A (mm)	Grate Overall Size B (mm)	Grate Depth C (mm)	Specifications
TG - 550	700Sq	1500Sq	25	BS - EN 124

Grey Cast Iron Round Tree Gratings

Features:-

- Grate in Two Pieces
- Grate Bolted Together
- Opening for Light Fixture

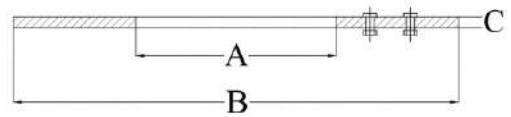
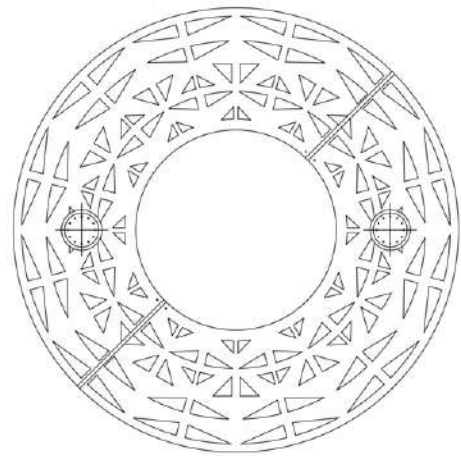

Product Code	Tree Opening A (mm)	Grate Overall Size B (mm)	Grate Depth C (mm)	Specifications
TG - 560	700Ø	1500Ø	25	B S - E N 124

Grey Cast Iron Round Tree Gratings

Features:-

- Grate in Two Pieces
- Grate Bolted Together

Options:-

- Opening for Light Fixtures

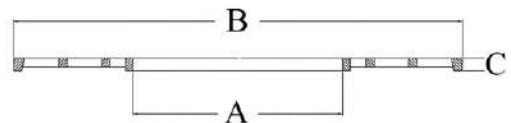
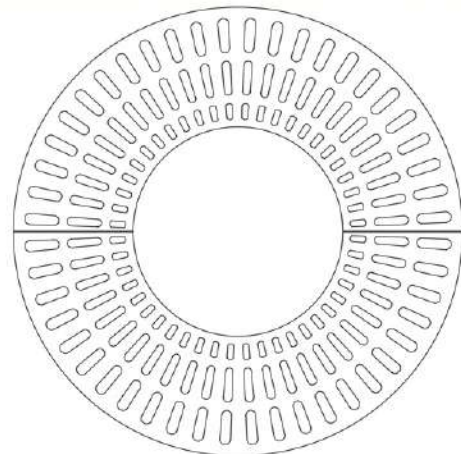

Product Code	Tree Opening A (mm)	Grate Overall Size B (mm)	Grate Depth C (mm)	Specifications
TG - 564 R 3	700Ø	1500Ø	45	B S - E N 124

Grey Cast Iron Square Tree Gratings

Features:-

- Grate in Two Pieces
- Grate Bolted Together
- Opening for Light Fixtures

Options:-

- Galvanized Mild Steel
- Angle Frame

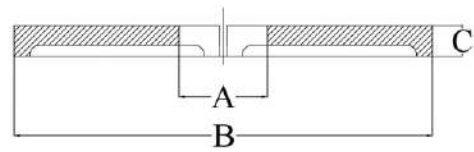
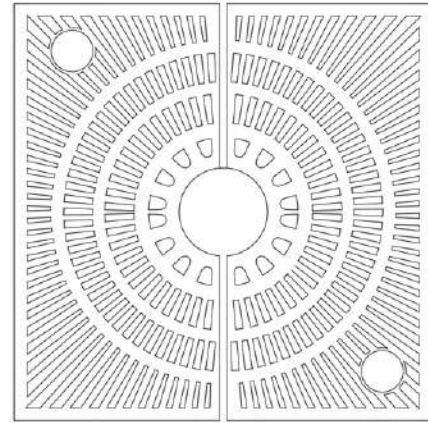

Product Code	Tree Opening A (mm)	Grate Overall Size B (mm)	Grate Depth C (mm)	Specifications
TG - 557 R 3	900Ø	2000Sq	45	BS - EN 124

Grey Cast Iron Round Tree Gratings

Features:-

- Grate in Two Pieces
- Grate Bolted Together
- Opening for Light Fixture

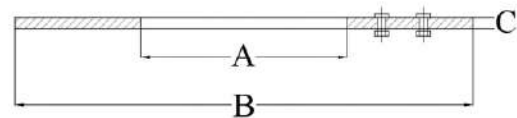
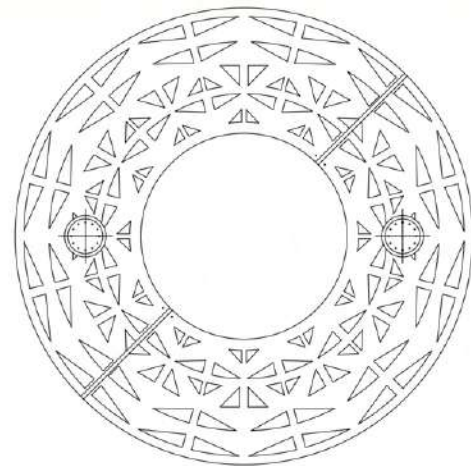

Product Code	Tree Opening A (mm)	Grate Overall Size B (mm)	Grate Depth C (mm)	Specifications
TG - 560 R 3	900Ø	2000Ø	36	BS - EN 124

Grey Cast Iron Square Tree Gratings

Features:-

- Grate in Two Pieces
- Grate Bolted Together
- Opening for Light Fixtures

Options:-

- Galvanized Mild Steel
- Angle Frame

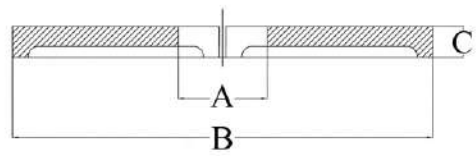
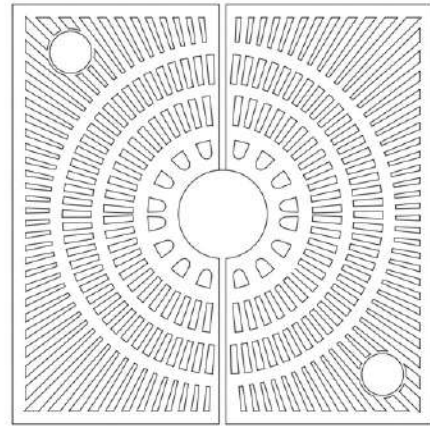

Product Code	Tree Opening A (mm)	Grate Overall Size B (mm)	Grate Depth C (mm)	Specifications
TG - 556	950Ø	1500Sq	63	BS - EN 124

Grey Cast Iron Square Tree Gratings

Features:-

- Grate in Two Pieces
- Grate Bolted Together
- Hot Dip Galvanized Steel
- Frame

Options:-

- Opening for Light Fixture

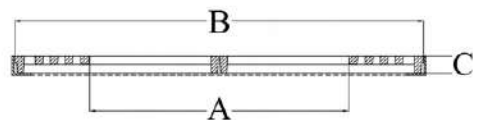
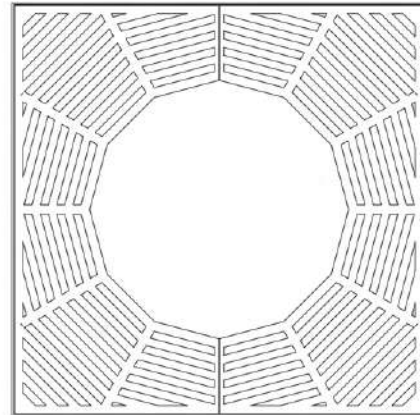
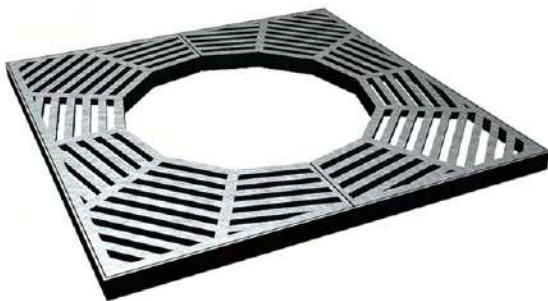

Product Code	Tree Opening A (mm)	Grate Overall Size B (mm)	Grate Depth C (mm)	Specifications
TG - 559 R 1	950Ø	1500Sq	63	BS - EN 124

Grey Cast Iron Square Tree Gratings

Features:-

- Grate in Two Pieces
- Grate Bolted Together
- Opening for Light Fixtures

Options:-

- Without Light Opening
- Mild Steel Support Frames

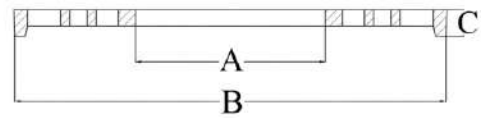
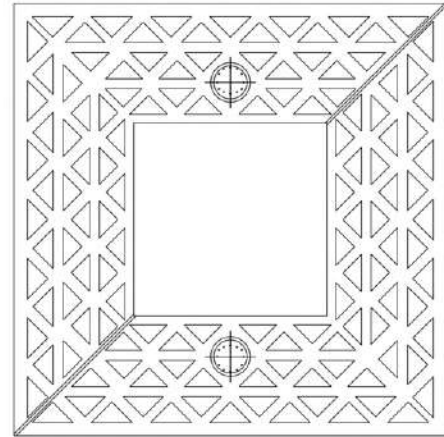
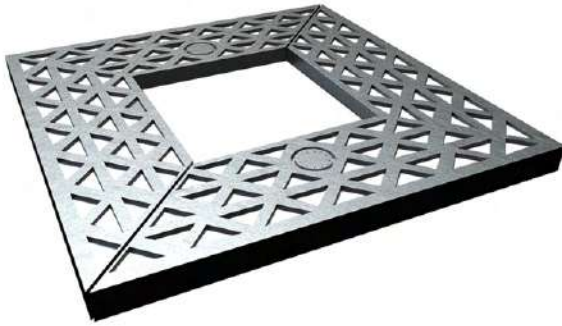

Product Code	Tree Opening A (mm)	Grate Overall Size B (mm)	Grate Depth C (mm)	Specifications
TG - 550 R 4	1000Sq	2000Sq	63	BS - EN 124

Grey Cast Iron Round Tree Gratings

Features:-

- Grate in Two Pieces
- Grate Bolted Together
- Opening for Light Fixture

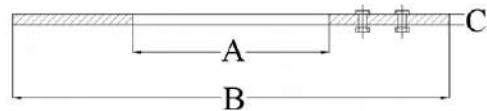
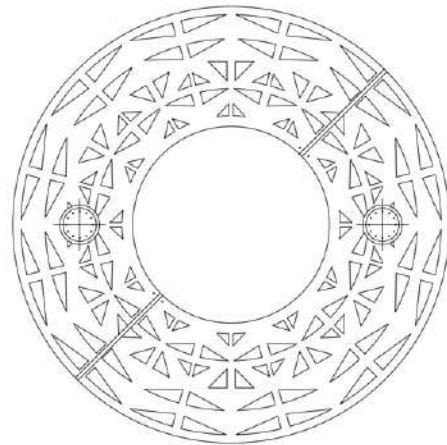

Product Code	Tree Opening A (mm)	Grate Overall Size B (mm)	Grate Depth C (mm)	Specifications
TG - 560 R 4	1000Ø	2000Ø	45	BS - EN 124



SURFACE BOX



Heavy Duty Grey Cast Iron Surface Box

Features:-

- Lifting Bar
- Cover Chain to Box
- Stainless Steel Chain

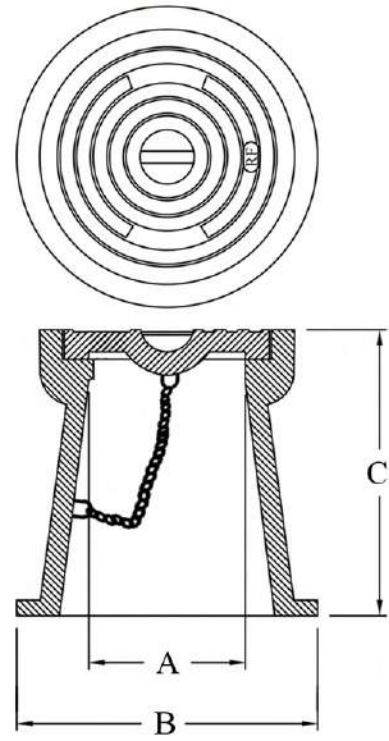

Product Code	Clear Opening A (mm)	Over Base B (mm)	Depth C (mm)	Specifications
SB - 600 (HD)	120Ø	200Ø	300	Heavy Duty - BS - 5834

Heavy Duty Ductile Cast Iron Surface Box

Features:-

- Lifting Handle
- Security Stainless Steel Chain

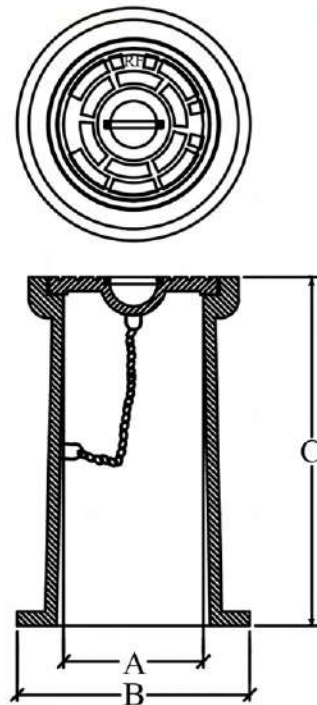

Product Code	Clear Opening A (mm)	Over Base B (mm)	Depth C (mm)	Specifications
SB - 600 DI (HD)	120Ø	200Ø	300	Heavy Duty - BS - 5834

Heavy Duty Grey Cast Iron Surface Box

Features:-

- Double Triangular
- Three Point Suspension
- Closed Key Holes
- Cover Chained to Frame
- Register

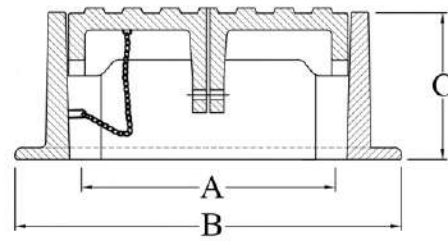
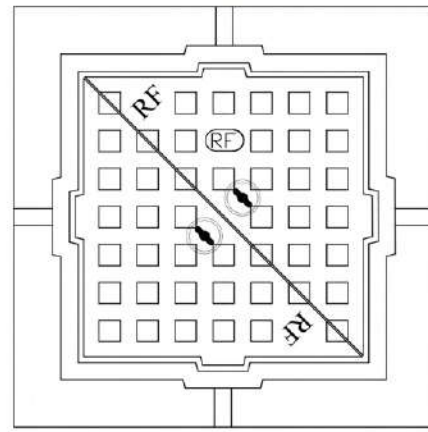

Product Code	Clear Opening A (mm)	Over Base B (mm)	Depth C (mm)	Specifications
SB - 640 DT (HD)	125Sq	225Sq	100	Heavy Duty - BS - 5834

Heavy Duty Grey Cast Iron Surface Box

Features:-

- Closed Key Holes
- Locking Device

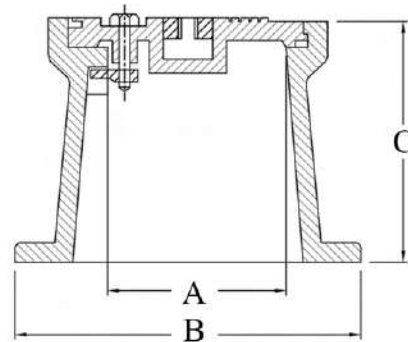
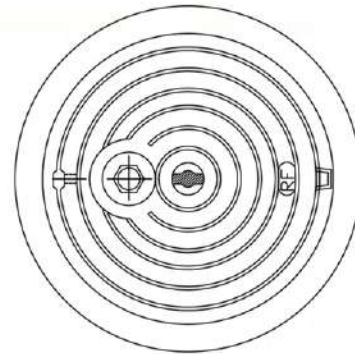

Product Code	Clear Opening A (mm)	Over Base B (mm)	Depth C (mm)	Specifications
SB - 615 (HD)	140Ø	270Ø	180	Heavy Duty - BS - 5834

Heavy Duty Grey Cast Iron Surface Box

Features:-

- Lifting Handle
- Locking Bar



WATER PROJECT - RIYADH

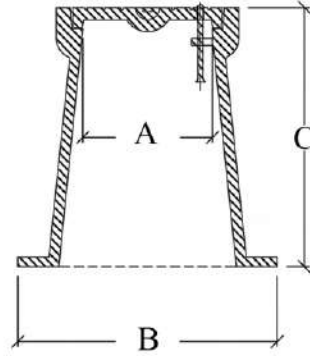
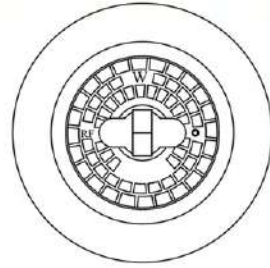

Product Code	Clear Opening A (mm)	Over Base B (mm)	Depth C (mm)	Specifications
SB - 620 R3 (HD) SB - 609 (HD)	140Ø 75Ø	270Ø 200Ø	270 190	Heavy Duty - BS - 5834 Heavy Duty - BS - 5834

Heavy Duty Grey Cast Iron Surface Box

Features:-

- Closed Key Holes
- Cover Chained to Frame
- Galvanized Steel Chain

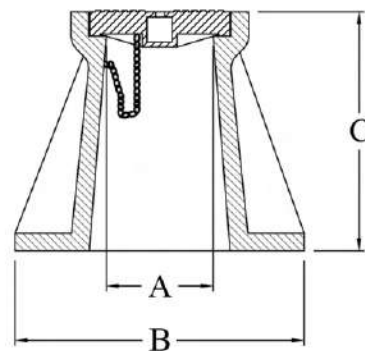
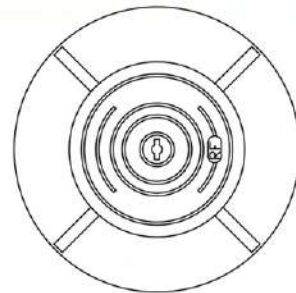

Product Code	Clear Opening A (mm)	Over Base B (mm)	Depth C (mm)	Specifications
SB - 610 (HD)	150Ø	380Ø	300	Heavy Duty - BS - 5834

Heavy Duty Grey Cast Iron Surface Box

Features:-

- Double Triangular
- Three Point Suspension
- Closed Key Holes
- Cover Chained to Frame
- Register

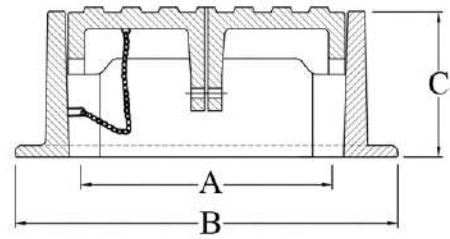
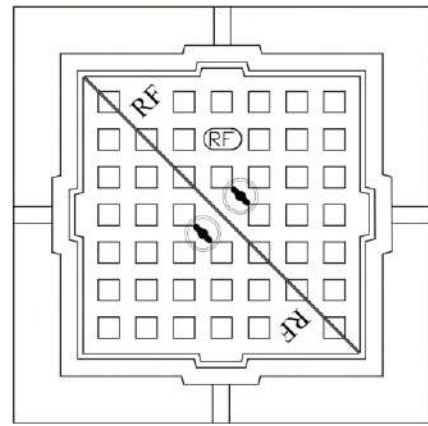

Product Code	Clear Opening A (mm)	Over Base B (mm)	Depth C (mm)	Specifications
SB - 640 DTA (HD)	150Sq	250Sq	100	Heavy Duty - BS - 5834

Heavy Duty Ductile Cast Iron Surface Box

Features:-

- Closed Key Holes
- Cover Chained to Frame
- Double Triangular
- Three Point Suspension
- Register

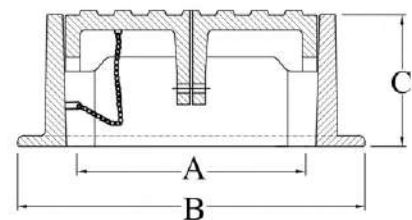
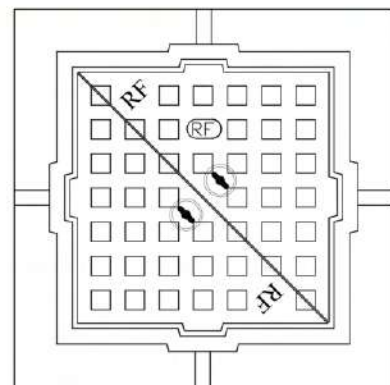

Product Code	Clear Opening A (mm)	Over Base B (mm)	Depth C (mm)	Specifications
SB - 640 DTD1 (HD)	150Sq	260Sq	100	Heavy Duty - BS - 5834

Heavy Duty Grey Cast Iron Surface Box

Features:-

- Closed Key Holes
- Locking Device

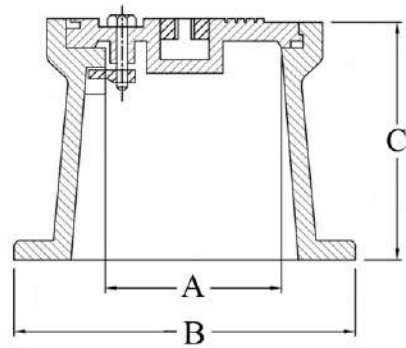
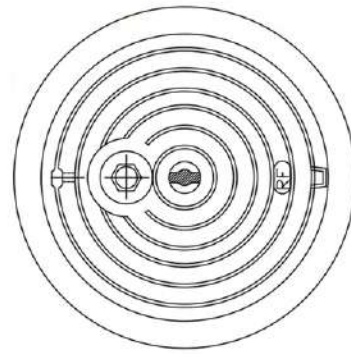

Product Code	Clear Opening A (mm)	Over Base B (mm)	Depth C (mm)	Specifications
SB - 615 R2 (HD)	160Ø	225Ø	250	Heavy Duty - BS - 5834

Heavy Duty Grey Cast Iron Surface Box

Features:-

- Lifting Handle
- Cover Chained to Frame
- Galvanized Steel Chain

Options:-

- Locking Device

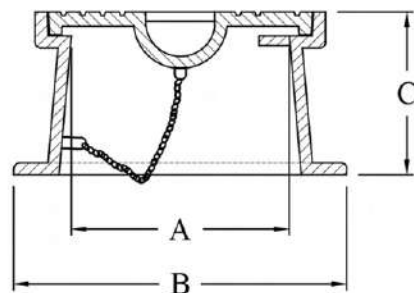
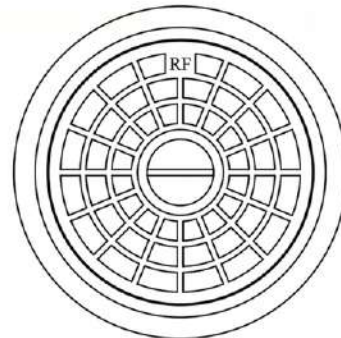

Product Code	Clear Opening A (mm)	Over Base B (mm)	Depth C (mm)	Specifications
SB - 620 (HD)	190Ø	275Ø	135	Heavy Duty - BS - 5834

Heavy Duty Grey Cast Iron Surface Box

Features:-

- Single Seal
- Locking Bolts
- Water Tight
- Gas Tight

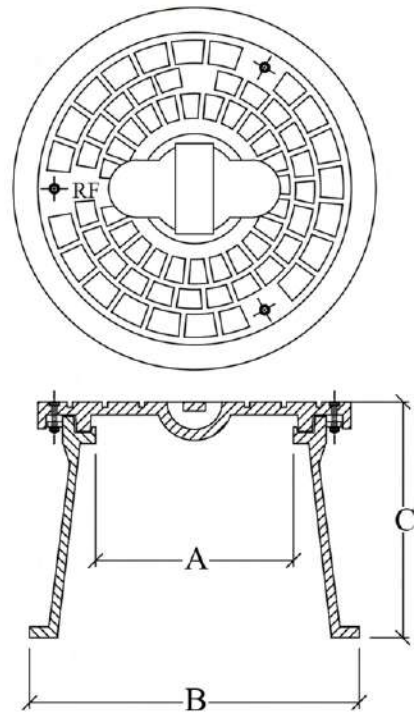

Product Code	Clear Opening A (mm)	Over Base B (mm)	Depth C (mm)	Specifications
SB - 620 R (HD)	1900	340Ø	215	Heavy Duty - BS - 5834

Heavy Duty Grey Cast Iron Adjustable Type Surface Box

Features:-

- Closed Key Holes

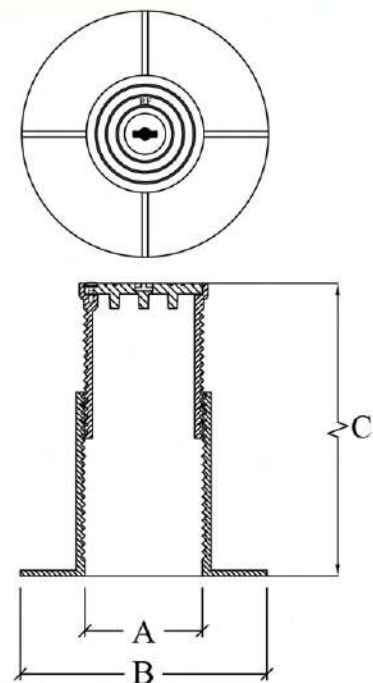

Product Code	Clear Opening A (mm)	Over Base B (mm)	Depth C (mm)	Specifications
RF - VD - 200 R1	200Ø	420Ø	315	Heavy Duty - BS - 5834

Heavy Duty Grey Cast Iron Surface Box

Features:-

- Closed Key Holes
- Locking Device

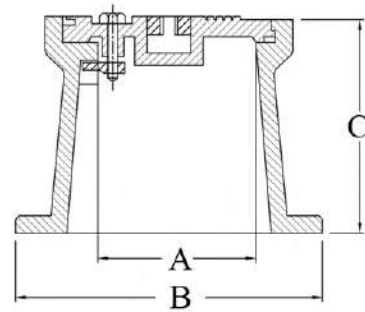
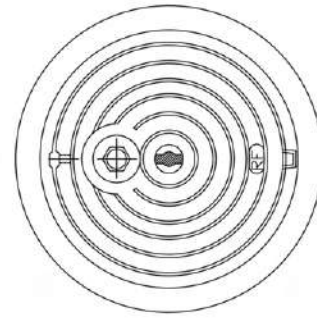

Product Code	Clear Opening A (mm)	Over Base B (mm)	Depth C (mm)	Specifications
SB - 616 (HD)	200Ø	330Ø	180	Heavy Duty - BS - 5834

Heavy Duty Grey Cast Iron Surface Box

Features:-

- Open Key Holes
- Cover Chained to Frame
- Locking Device

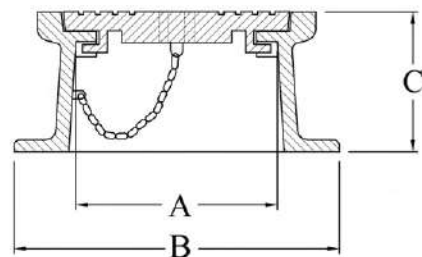
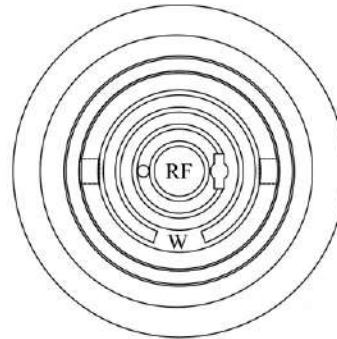

Product Code	Clear Opening A (mm)	Over Base B (mm)	Depth C (mm)	Specifications
SB - 630 (HD)	200Ø	350Ø	140	Heavy Duty - BS - 5834

Heavy Duty Grey Cast Iron Surface Box

Features:-

- Closed Key Holes
- Cover Chained to Frame

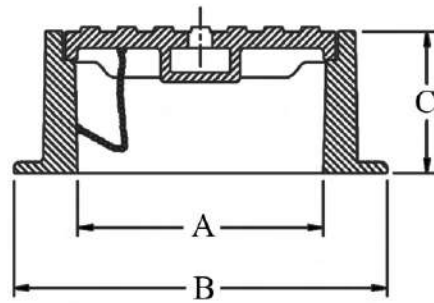
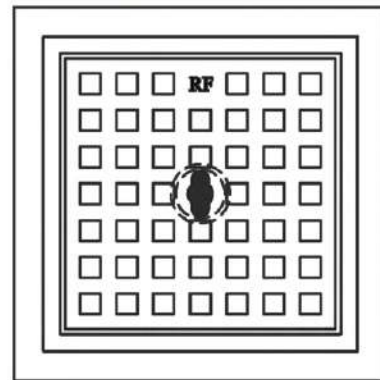

Product Code	Clear Opening A (mm)	Over Base B (mm)	Depth C (mm)	Loading (TONS)	Specifications
SB - 640 (HD)	250Sq	375Sq	145	Heavy Duty	BS EN 124

Heavy Duty Grey Cast Iron Surface Box

Features:-

- Open Key Holes
- Cover Chained to Frame
- Locking Device

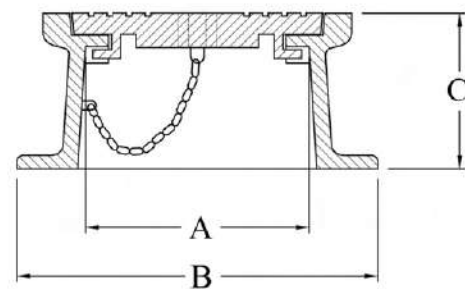
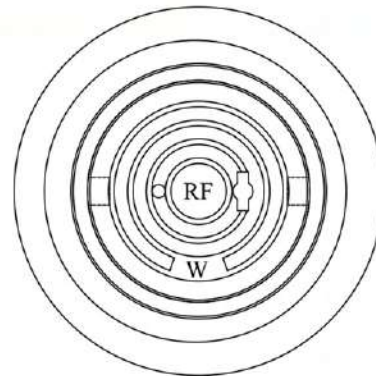

Product Code	Clear Opening A (mm)	Over Base B (mm)	Depth C (mm)	Specifications
SB - 636 (HD)	280Ø	370Ø	200	Heavy Duty - BS - 5834

Heavy Duty Ductile Cast Iron Surface Box

Features:-

- Open Key Hole
- Vent Hole
- Two Locking Leg
- Cover Chained to Frame by Stainless Steel Chain

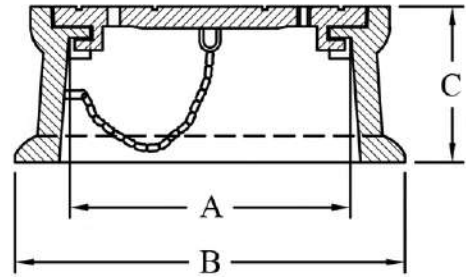
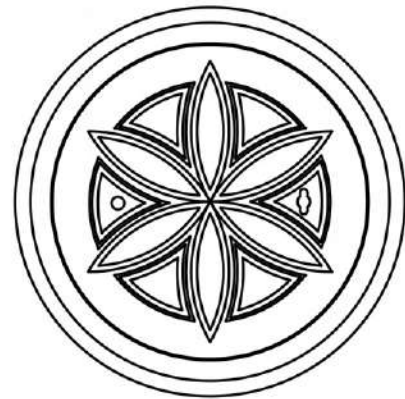

Product Code	Clear Opening A (mm)	Over Base B (mm)	Depth C (mm)	Specifications
SB - 631 R1 DI (HD)	280Ø	370Ø	140	Heavy Duty - BS - 5834

Heavy Duty Grey Cast Iron Surface Box

Features:-

- Open Key Holes
- Cover Chained to Frame
- Locking Device

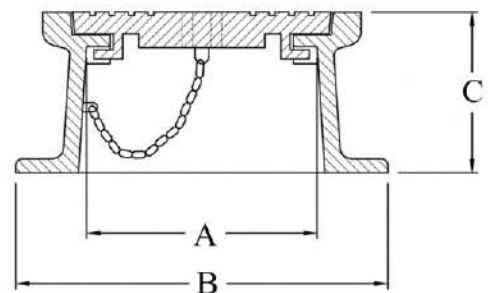
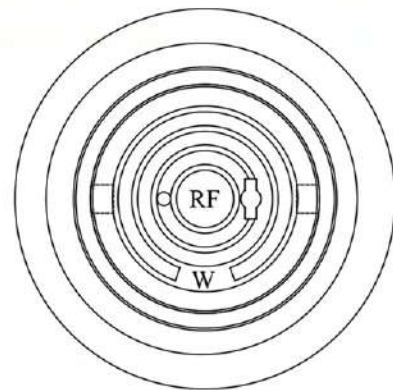

Product Code	Clear Opening A (mm)	Over Base B (mm)	Depth C (mm)	Specifications
SB - 631 (HD)	290Ø	375Ø	150	Heavy Duty - BS - 5834



Heavy Duty Grey Cast Iron Surface Box

Features:-

- Lifting Handle
- Cover Chained to Frame
- Galvanized Steel Chain

Options:-

- Locking Device

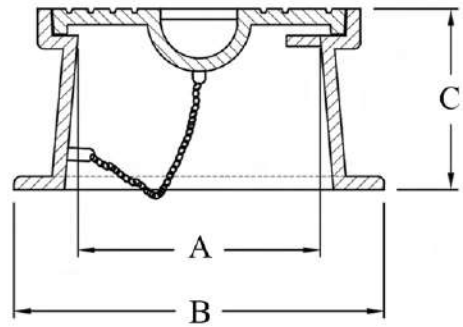
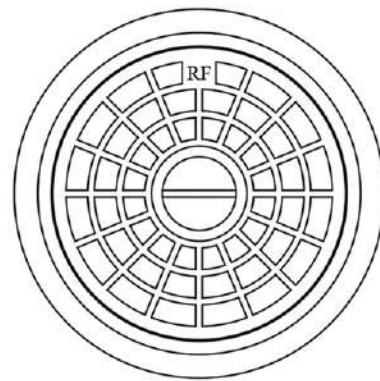

Product Code	Clear Opening A (mm)	Over Base B (mm)	Depth C (mm)	Specifications
SB - 621 (HD)	300Ø	400Ø	200	Heavy Duty - BS - 5834

Heavy Duty Grey Cast Iron Surface Box

Features:-

- Single Seal
- Locking Bolts
- Water Tight
- Gas Tight

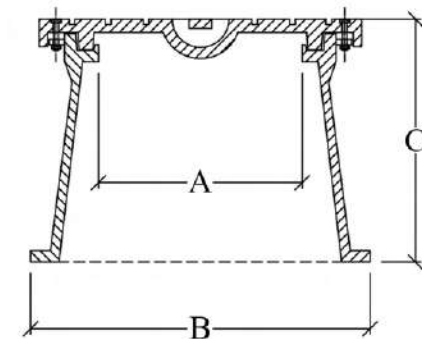
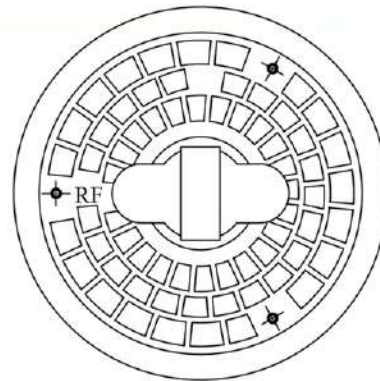

Product Code	Clear Opening A (mm)	Over Base B (mm)	Depth C (mm)	Specifications
SB - 620 R1(HD)	300Ø	450Ø	215	Heavy Duty - BS - 5834

Heavy Duty Grey Cast Iron Surface Box

Features:-

- Double Triangular
- Three Point Suspension
- Closed Key Holes
- Cover Chained to Frame
- Register

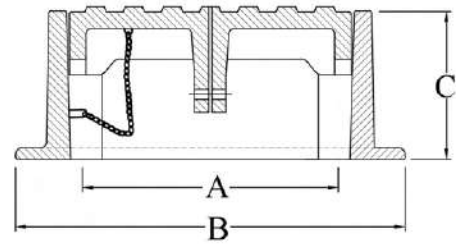
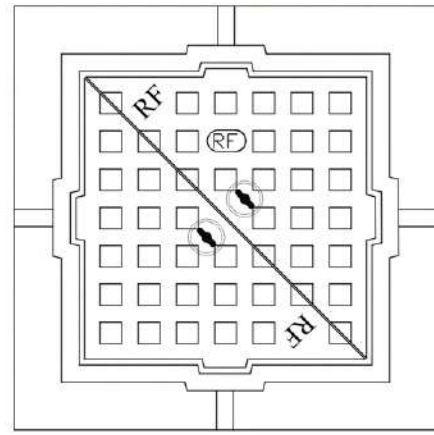

Product Code	Clear Opening A (mm)	Over Base B (mm)	Depth C (mm)	Specifications
SB - 640 DTB (HD)	300Sq	420Sq	50	Heavy Duty - BS - 5834

Heavy Duty Grey Cast Iron Surface Box

Features:-

- Closed Key Hole
- Cover Chained to Frame

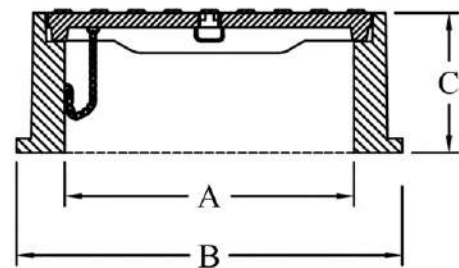
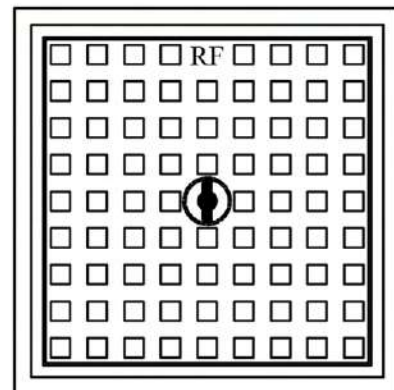

Product Code	Clear Opening A (mm)	Over Base B (mm)	Depth C (mm)	Specifications
SB - 650 A (HD)	300Sq	425Sq	100	Heavy Duty - BS - 5834

Heavy Duty Grey Cast Iron Surface Box

Features:-

- Locking Device
- Closed Lifting Key Holes
- Cover Chain to Frame
- Register

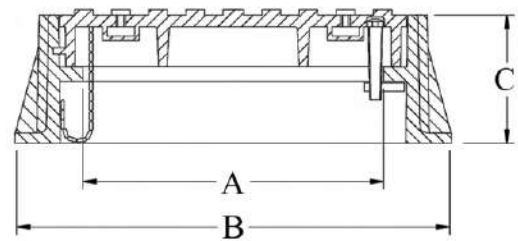
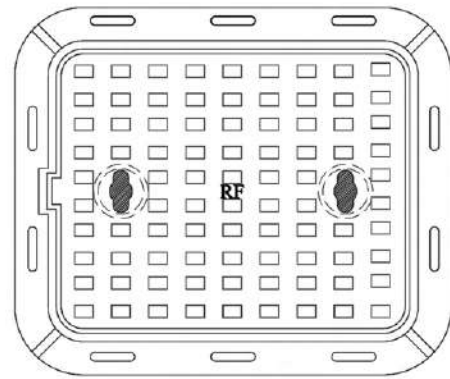

Product Code	Clear Opening A (mm)	Over Base B (mm)	Depth C (mm)	Loading (TONS)	Specifications
SB - 645 (HD)	325Sq	480Sq	100	Heavy Duty	Heavy Duty - BS - 5834

Heavy Duty Ductile Cast Iron Surface Box

Features:-

- Locking Device
- Cover Chain to Frame
- Close Lifting Key Holes
- Register

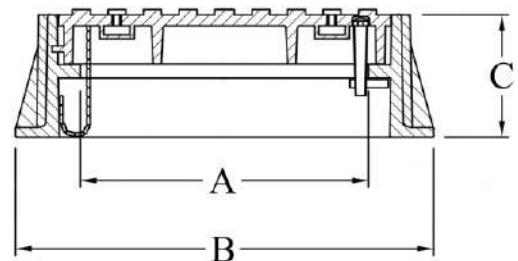
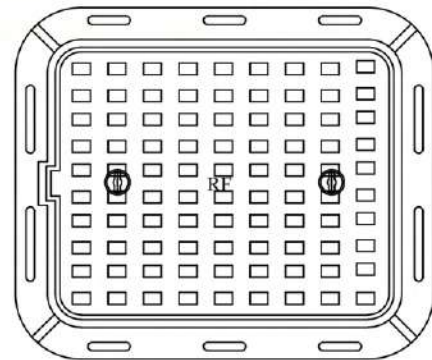

Product Code	Clear Opening A (mm)	Over Base B (mm)	Depth C (mm)	Specifications
SB - 645 DI (HD)	325Sq	480Sq	100	Heavy Duty - BS - 5834

Heavy Duty Grey Cast Iron Surface Box

Features:-

- Locking Device
- Closed Lifting Key Holes
- Cover Chain to Frame
- Register

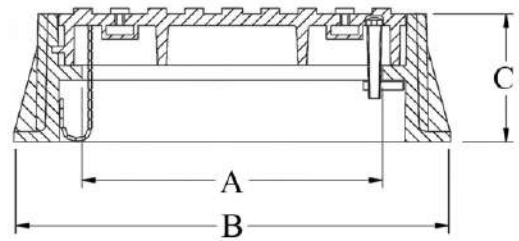
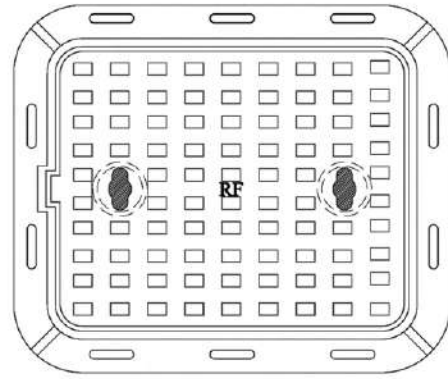

Product Code	Clear Opening A (mm)	Over Base B (mm)	Depth C (mm)	Loading (TONS)	Specifications
SB - 646 (HD)	380 X 325	530 X 380	125	Heavy Duty	Heavy Duty - BS - 5834

Heavy Duty Ductile Cast Iron Surface Box

Features:-

- Locking Device
- Cover Chain to Frame
- Close Lifting Key Holes
- Register

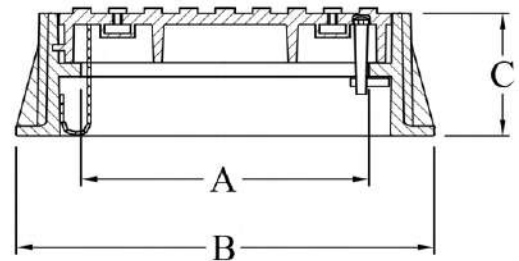
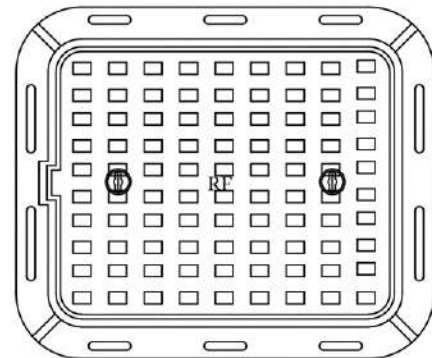

Product Code	Clear Opening A (mm)	Over Base B (mm)	Depth C (mm)	Specifications
SB - 646 DI (HD)	380 X 325	530 X 380	125	Heavy Duty - BS - 5834





WATER METER BOX



Grey Cast Iron Water Meter Box

Features:-

- Single Lid Top
- Closed Lifting Holes
- Combined Locking and Lifting
- Pipe Outlet 50mm Dia
- Cover Inscribed with Water Meter

Options:-

- Outlet Dia According to Customer Requirement
- Bottom Drain Hole

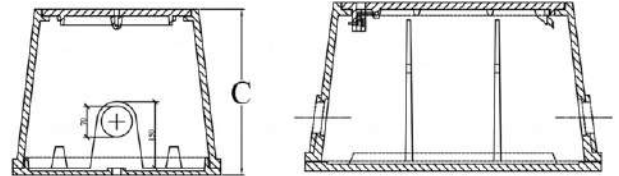
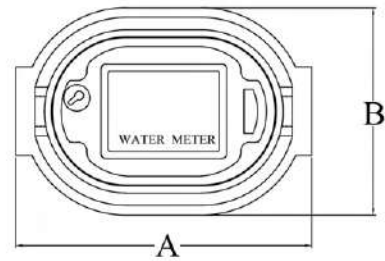

Product Code	Over Base A x B	Depth C (mm)	Specifications
WM - 704	335 X 325	190	BS - EN 124

Grey Cast Iron Water Meter Box with Single Lid

Features:-

- Two Closed Lifting Key Holes
- Single Lid
- Bronze Lock
- Cover Badged Water Meter
- Pipe Outlet Size 42mm Dia Or 25mm Dia

Options:-

- Outlet Dia According to Customer Requirement

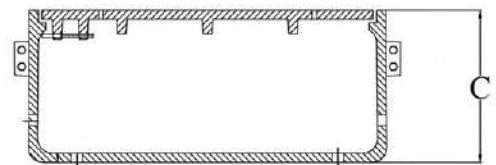
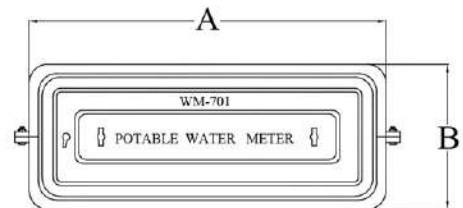

Product Code	Over Base A x B	Depth C (mm)	Specifications
WM - 701 A	405 X 197	190	BS - EN 124

Grey Cast Iron Water Meter Box

Features:-

- Single Lid Top
- Combined Locking and Lifting
- Pipe Outlet 50mm Dia
- Cover Inscribed With Water Meter

Options:-

- Outlet Dia According to Customer Requirement
- Bottom Drain Hole

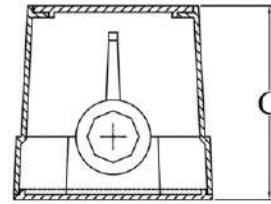
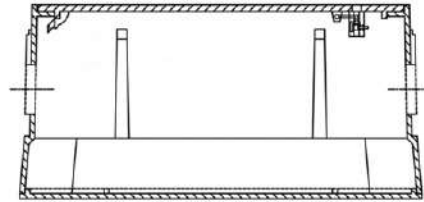
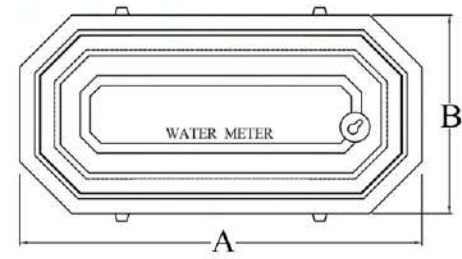

Product Code	Over Base A x B	Depth C (mm)	Specifications
WM - 703	405 X 200	195	BS - EN 124

Grey Cast Iron Water Meter Box

Features:-

- Two Closed Lifting Key Holes
- Single Lid
- Bronze Lock
- Cover Badged Water Meter
- Pipe Outlet Size 42mm Dia Or 25mm Dia

Options:-

- Outlet Dia According to Customer Requirement

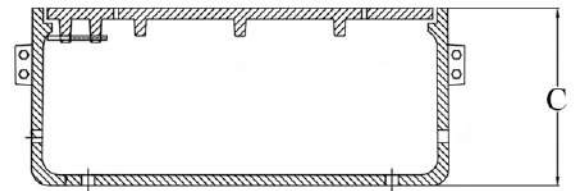
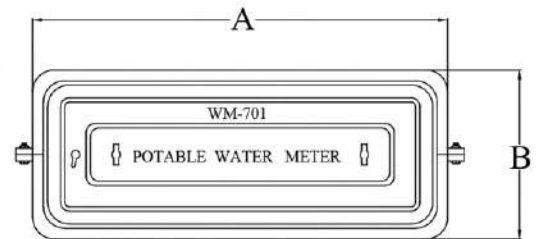

Product Code	Over Base A x B	Depth C (mm)	Specifications
WM - 705	450 X 250	200	BS - EN 124

Grey Cast Iron Water Meter Box

Features:-

- Three Piece Lid
- Two Half Frame Bolted Together
- Combined Locking and Lifting
- Drain Hole
- 2" Dia Pipe Outlet

Options:-

- Outlet Dia According to Customer Requirement

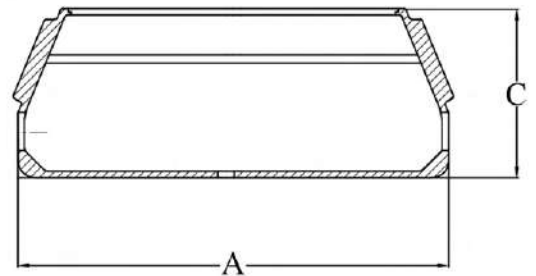
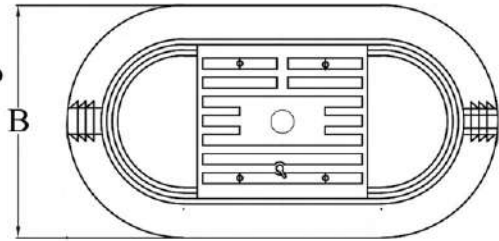

Product Code	Over Base A x B	Depth C (mm)	Specifications
WM - 702	767 X 425	323	BS - EN 124

Grey Cast Iron Water Meter Box

Features:-

- Two Closed Lifting Key Holes
- Single Lid
- Bronze Lock
- Cover Badged Water Meter
- Pipe Outlet Size 42mm Dia Or 25mm Dia

Options:-

- Outlet Dia According to Customer Requirement

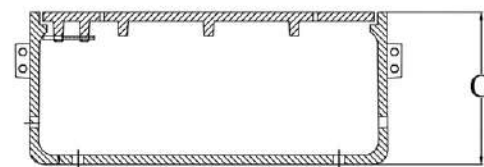
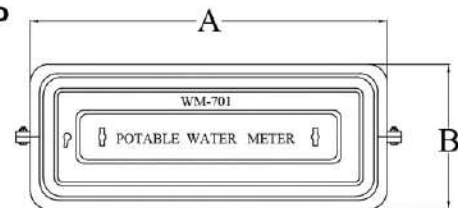

Product Code	Over Base A x B	Depth C (mm)	Specifications
WM - 701	900 X 350	415	BS - EN 124



Grey Cast Iron Water Meter Box

Features:-

- Two Closed Lifting Key Holes
- Single Lid
- Bronze Lock
- Cover Badged Water Meter
- Pipe Outlet Size Available at 42mm Dia, 25mm Dia and also as per Customer Requirement

Options:-

- Outlet Dia According to Customer Requirement

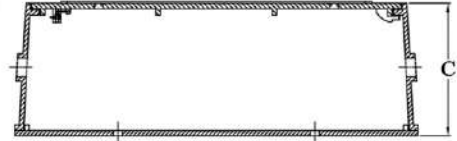
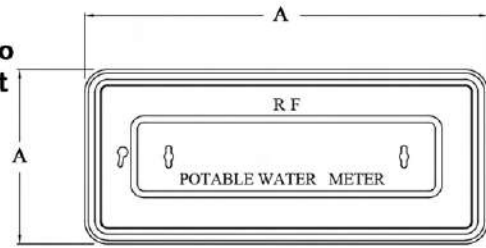

Product Code	Over Base A (mm)	Depth C (mm)	Specifications
WM - 700	900 X 395	300	BS - EN 124

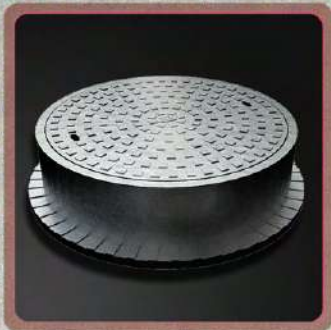

APPROVALS
SAUDI ARAMCO



Heavy Duty Grey Cast Iron Covers and Frames

Features:-

- Open Key Holes
- Register
- Three Prising Slots
- 12 - 20mm Vent Holes

Options:-

- Without Vent Holes
- Closed Key Holes
- 4 - 20mm Vent Holes

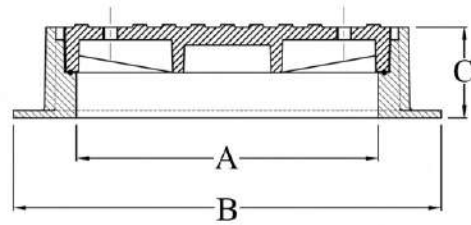
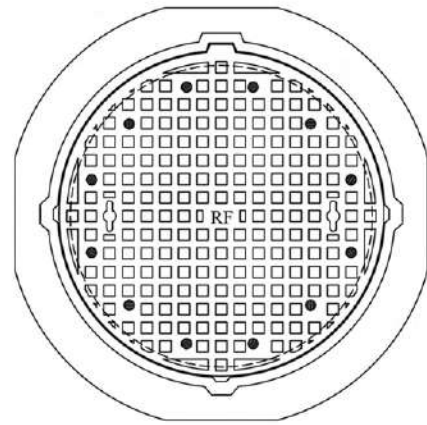

Aramco Ref : AE 036083 Sheet - 02 / Rev.01

Product Code	Clear Opening A (mm)	Over Base B (mm)	Depth C (mm)	Loading (TONS)	Specifications
MC - 110 R (HD)	600Ø	820Ø	180	40	ARAMCO

Heavy Duty Grey Cast Iron Curved (Convex) Covers and Frames

Features:-

- Closed Key Holes
- Register
- Three Prising Slots

Options:-

- Vent Holes

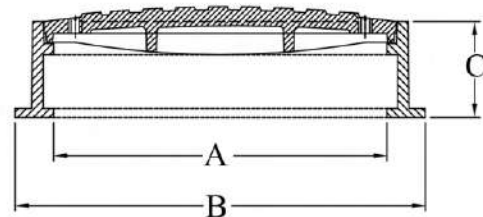
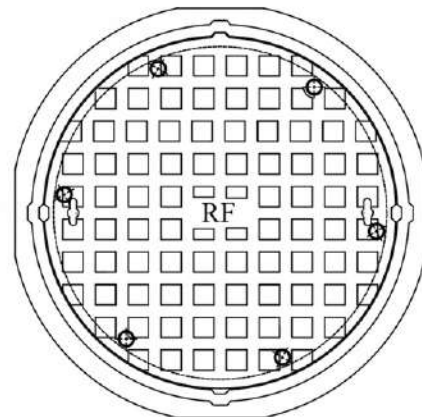

Aramco Ref : AE 036083 Sheet - 01 / Rev.05

Product Code	Clear Opening A (mm)	Over Base B (mm)	Depth C (mm)	Loading (TONS)	Specifications
MC - 110 R2 (HD)	600Ø	820Ø	180	40	ARAMCO



Heavy Duty Grey Cast Iron Covers and Frames

Features:-

- Closed Key Holes

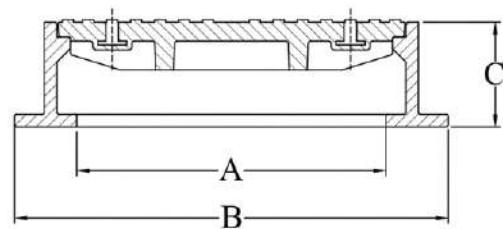
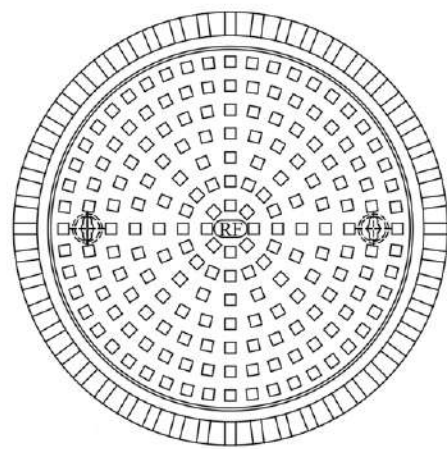

Aramco Ref : AE 036082

Product Code	Clear Opening A (mm)	Over Base B (mm)	Depth C (mm)	Loading (TONS)	Specifications
MC - 125 (HD)	622Ø	850Ø	208	35	ARAMCO

Heavy Duty Grey Cast Iron Large Covers and Frames

Features:-

- Closed Key Holes
- Two Locking Bolts
- Four Prising Slots
- 4 - 25mmØ Foundation Bolt Holes

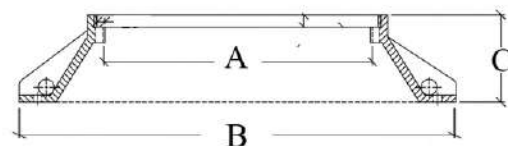
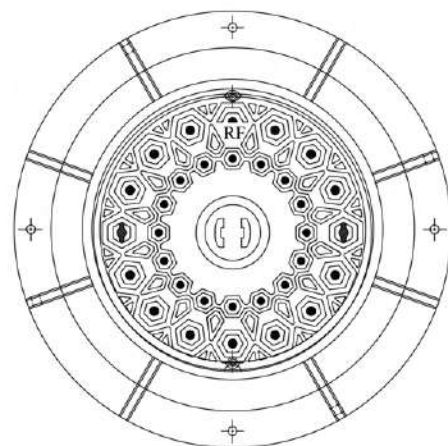

Product Code	Clear Opening A (mm)	Over Base B (mm)	Depth C (mm)	Loading (TONS)	Specifications
MC - 170 R (HD)	760Ø	1250Ø	250	40	ARAMCO

Grey Cast Iron Catch Basin for 10" used for Oily / Storm Water System Open Gate Inlets

ARAMCO Ref No : AB - 339115

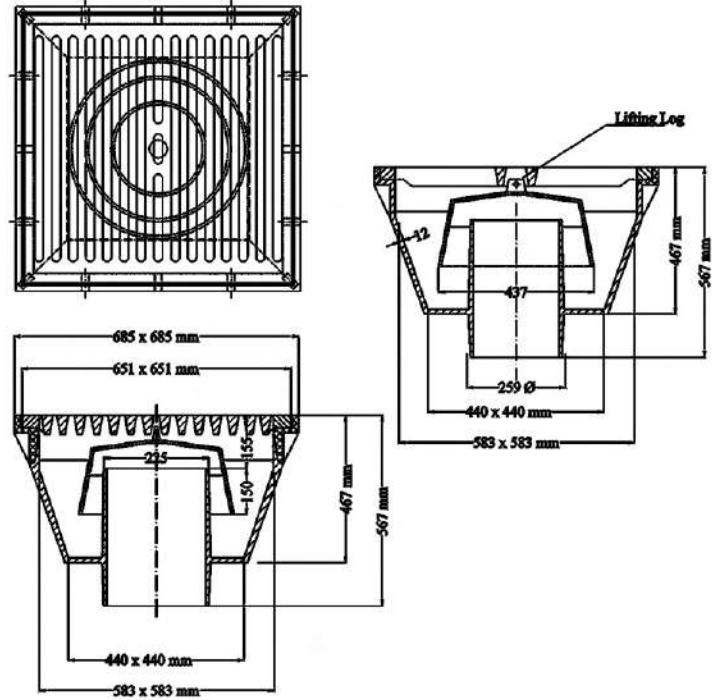

Grey Cast Iron Catch Basin for 6" Outlet Sewer Connection Open Gate

ARAMCO Ref No : AB - 036402

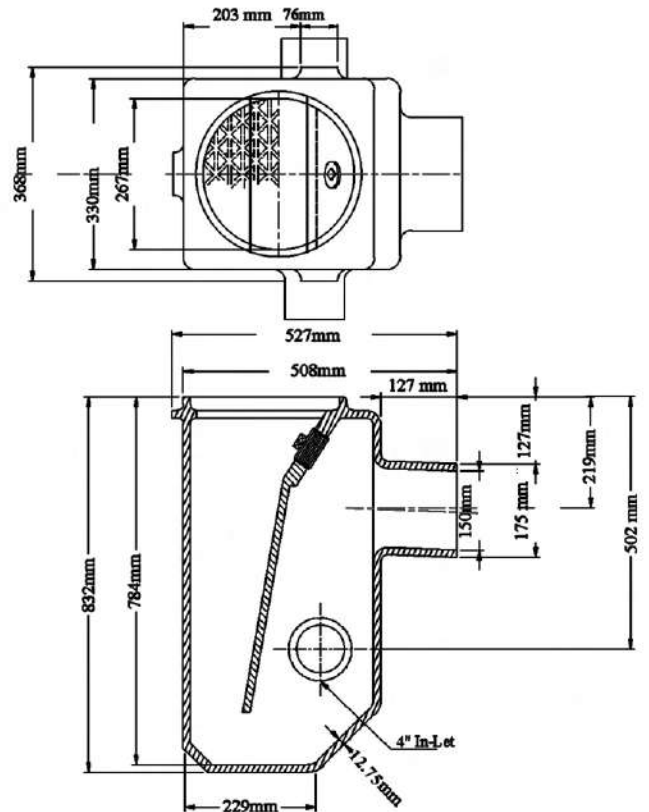

Grey Cast Iron Catch Basin for 6" used for Oily / Storm Water System Open Grate Inlets

ARAMCO Ref No : AB - 036964

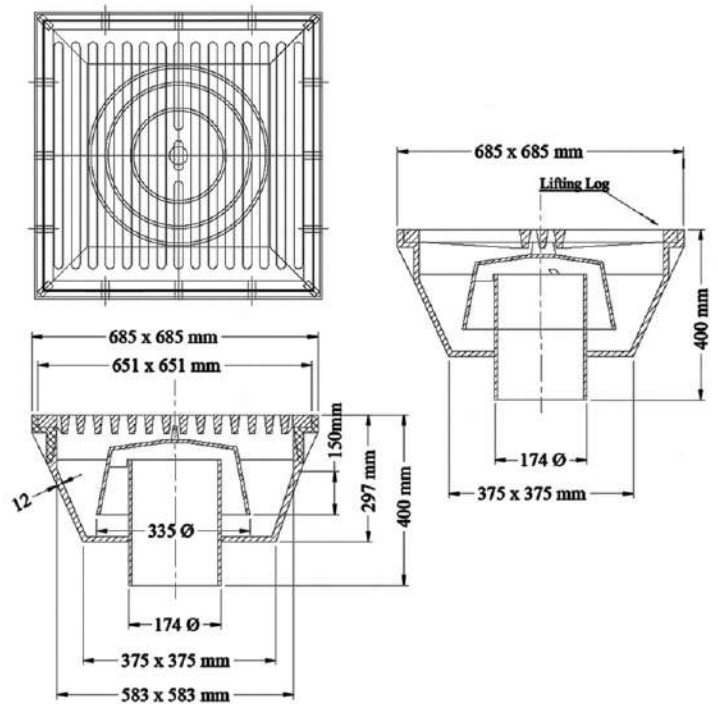

Grey Cast Iron Catch Basin for 8" used for Oily / Storm Water System Open Grate Inlets

ARAMCO Ref No : AB - 036013

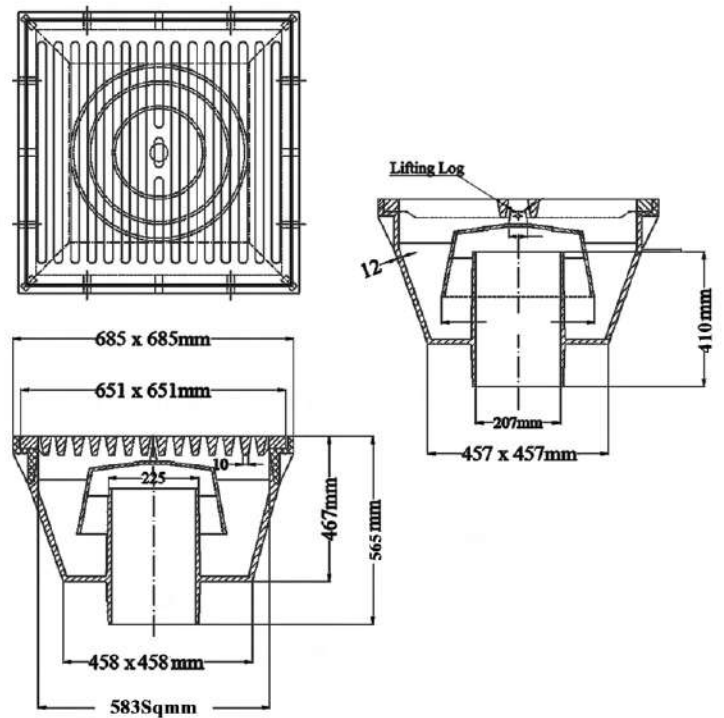

**Grey Cast Iron Catch Basin for 6" Outlet Sewer Connection
Open Grate**

ARAMCO Ref No : AC - 036078

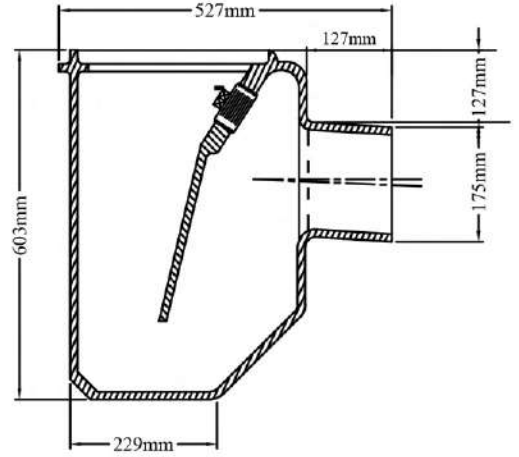
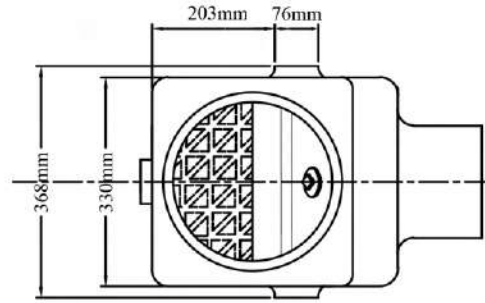

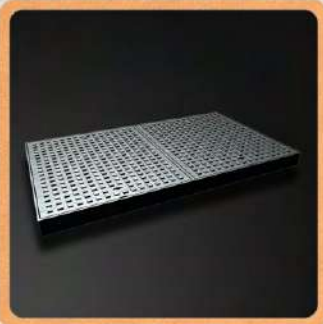
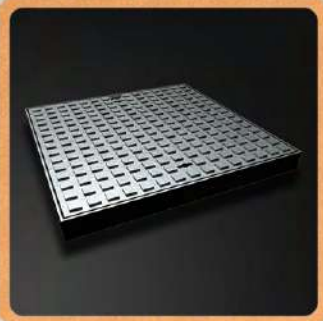

APPROVALS
TELECOMMUNICATION

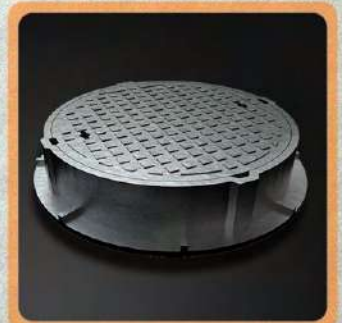
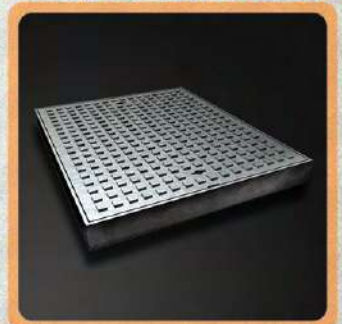

(SAUDI TELECOM CO.)

Heavy Duty Grey Cast Iron Covers and Frames

Features:-

- Closed Key Holes
- Two Locking Device
- Three Prising Slots
- Register
- Stainless Steel Bolts

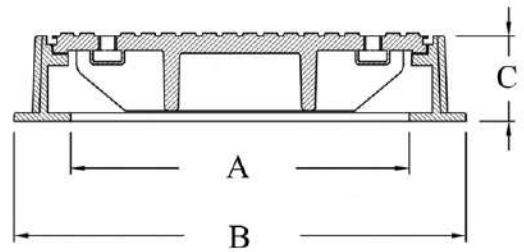
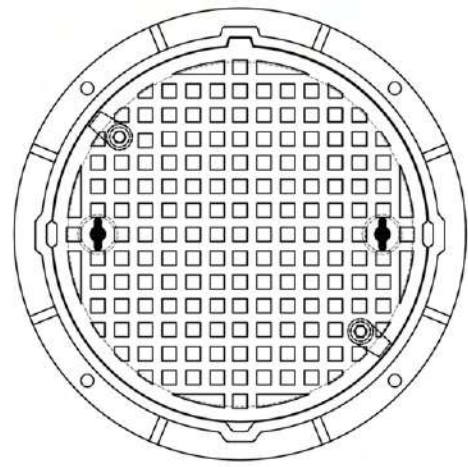

Product Code	Clear Opening A (mm)	Over Base B (mm)	Depth C (mm)	Loading (TONS)	Specifications
MC - 115 R3 N (HD)	595Ø	795Ø	150	40	BS - EN 124

(SAUDI TELECOM CO.)

Light, Medium and Heavy Duty Grey Cast Iron Covers with Mild Steel Angle Frames

Features:-

- Galvanized Steel Frame 50 X 50 X 5mm
- Closed Key Holes
- Prising Slots
- Cover Size 680 X 680 mm
- Fish Tail Anchors

Options:-

- 2 Nos Locking System each Cover

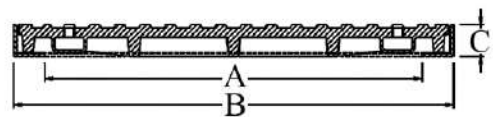
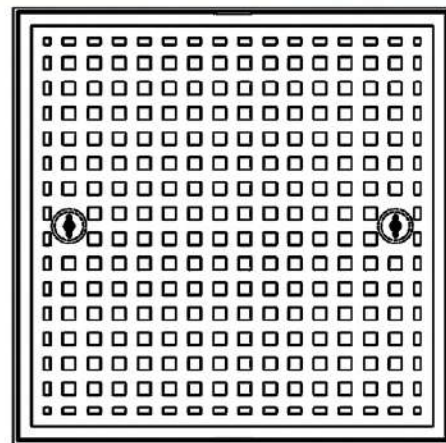
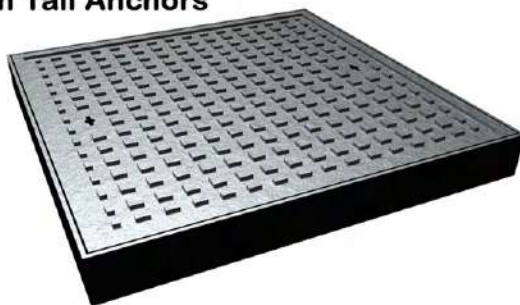

Product Code	Clear Opening A (mm)	Over Base B (mm)	Depth C (mm)	Loading (TONS)	Specifications
MC - 680 X 680 C1 (LD)	595Sq	695Sq	50	1.5	BS - EN 124
MC - 680 X 680 C1 (MD)	595Sq	695Sq	50	12.5	BS - EN 124
MC - 680 X 680 C1 (HD)	595Sq	695Sq	50	40	BS - EN 124



(SAUDI TELECOM CO.)

Light, Medium and Heavy Duty Grey Cast Iron Covers with Mild Steel Angle Frames

Features:-

- Galvanized Steel Frame 50 X 50 X 5mm
- Closed Key Holes
- Prising Slots
- Cover Size 684 X 684 mm
- Fish Tail Anchors

Options:-

- 2 Nos Locking System each Cover

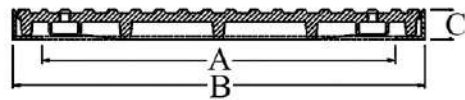
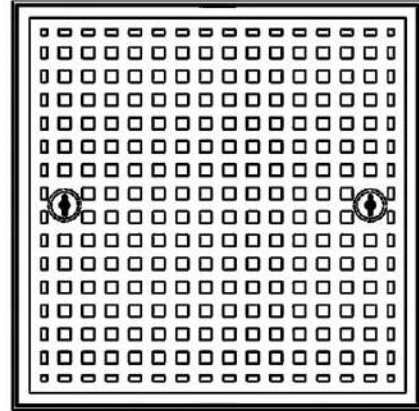

Product Code	Clear Opening A (mm)	Over Base B (mm)	Depth C (mm)	Loading (TONS)	Specifications
MC - 684 X 684 C1 (LD)	600Sq	700Sq	50	1.5	BS - EN 124
MC - 684 X 684 C1 (MD)	600Sq	700Sq	50	12.5	BS - EN 124
MC - 684 X 684 C1 (HD)	600Sq	700Sq	50	40	BS - EN 124

(SAUDI TELECOM CO.)

Light, Medium and Heavy Duty Grey Cast Iron Covers with Mild Steel Angle Frames

Features:-

- Galvanized Steel Frame 50 X 50 X 5mm
- Closed Key Holes
- Prising Slots
- Cover Size 690 X 690mm
- Fish Tail Anchors

Options:-

- 2 Nos Locking System each Cover

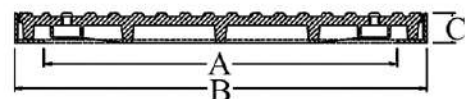
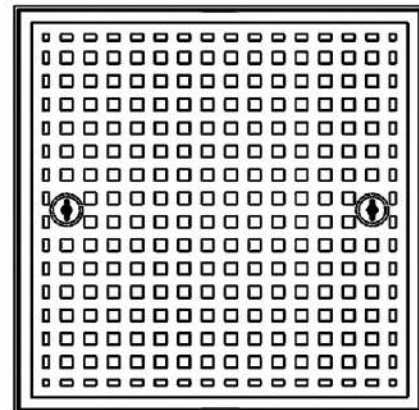
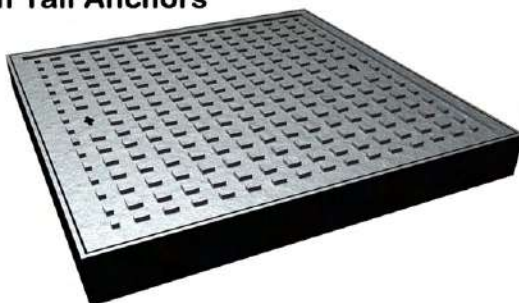

Product Code	Clear Opening A (mm)	Over Base B (mm)	Depth C (mm)	Loading (TONS)	Specifications
MC - 690 X 690 C1 (LD)	605Sq	705Sq	50	1.5	BS - EN 124
MC - 690 X 690 C1 (MD)	605Sq	705Sq	50	12.5	BS - EN 124
MC - 690 X 690 C1 (HD)	605Sq	705Sq	50	40	BS - EN 124



(SAUDI TELECOM CO.)

Heavy Duty Grey Cast Iron Covers and Frames

Features:-

- Four Holes for Anchoring
- 4 Nos Air Vent Holes
- Two Prising Slots

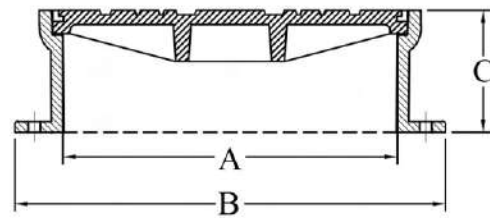
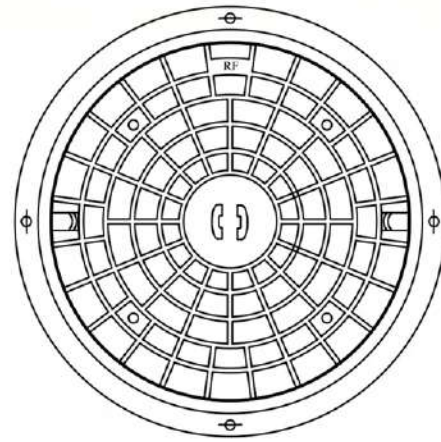

Product Code	Clear Opening A (mm)	Over Base B (mm)	Depth C (mm)	Loading (TONS)	Specifications
MC - 120 A (HD)	680Ø	880Ø	250	35	BS - EN 124

(SAUDI TELECOM CO.)

Heavy Duty Grey Cast Iron Covers and Frames

Features:-

- Four Holes For Anchoring
- Four Closed Lifting Key Holes
- Two Prising Slots
- Four Vent Holes

Options:-

- Open Key Holes
- Without Vent Hole

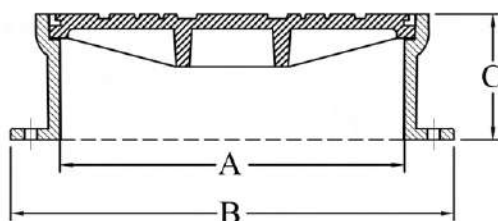
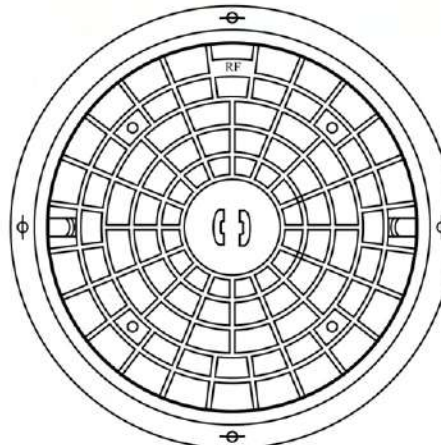

Product Code	Clear Opening A (mm)	Over Base B (mm)	Depth C (mm)	Loading (TONS)	Specifications
MC - 120 A4 (HD)	690Ø	918Ø	250	35	BS - EN 124



(SAUDI TELECOM CO.)

Light Medium and Heavy Duty Grey Cast Iron Covers with Mild Steel Angle Frames

Features:-

- Galvanized Steel Frame
- Closed Key Holes
- Two Prising Slots on Each Cover
- Cover Size = 600 X 700mm
- Cover Depth = 63mm
- Angle Frame Used 70 X 70 X 7mm
- Fish Tail Anchors

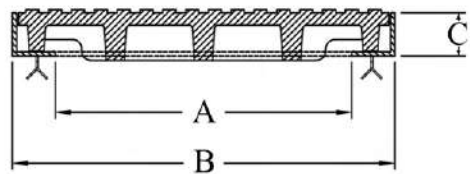
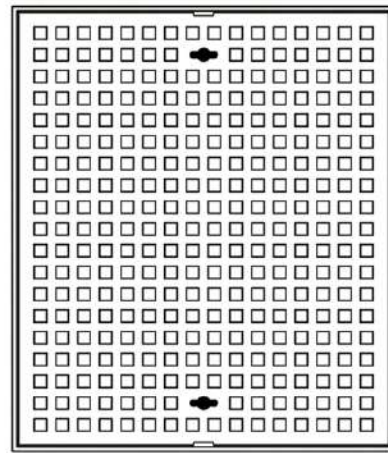

Product Code	Clear Opening A (mm)	Over Base B (mm)	Depth C (mm)	Loading (TONS)	Specifications
MC - 350 C1 (LD)	580 X 480	720 X 620	70	1.5	BS - EN 124
MC - 350 C1 (MD)	580 X 480	720 X 620	70	12.5	BS - EN 124
MC - 350 C1 (HD)	580 X 480	720 X 620	70	40	BS - EN 124

(SAUDI TELECOM CO.)

Heavy Duty Grey Cast Iron Covers with Mild Steel Angle Frames

Features:-

- Galvanized Steel Frame Use 50 X 50 X 5mm
- Closed Key Holes
- Cover Depth 45mm
- Fish Tail Anchors

Options:-

- Locking System Two Nos on Each Cover

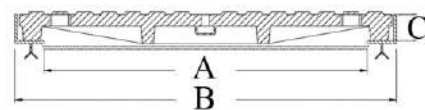
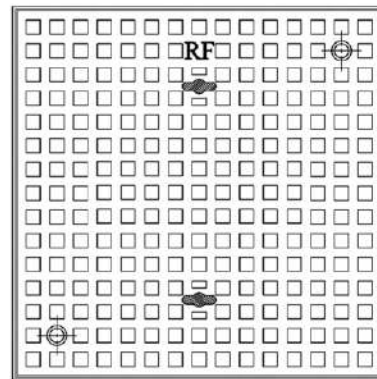

Product Code	Cover Size	Clear Opening A (mm)	Over Base B (mm)	Depth C (mm)	Loading (TONS)	Specifications
MC - 646 X 646 C1 (HD)	646 X 646	560 X 560	660 X 660	50	40	BS - EN 124



(SAUDI TELECOM CO.)

Light Medium and Heavy Duty Grey Cast Iron Multiple Covers with Mild Steel Angle Frames

Features:-

- Galvanized Steel Frame
- Closed Key Holes
- Prising Slots on each cover
- Removable "T" Bar
- Cover Size 600 X 700
- Fish Tail Anchors
- Angle Frame Used 70 X 70 X 7mm

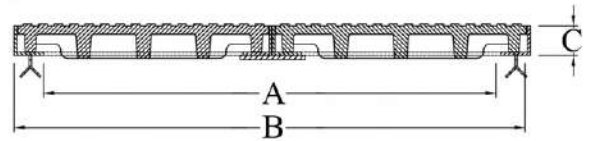
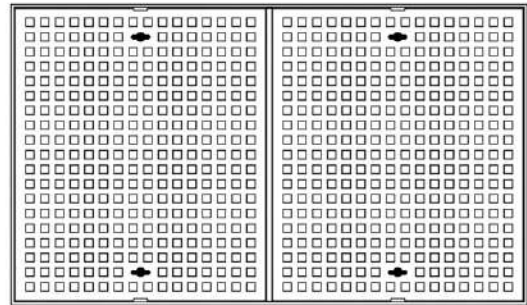

Product Code	Clear Opening A (mm)	Over Base B (mm)	Depth C (mm)	Loading (TONS)	Specifications
MC - 350 C2 (LD)	1100 X 580	1240 X 720	70	1.5	BS - EN 124
MC - 350 C2 (MD)	1100 X 580	1240 X 720	70	12.5	BS - EN 124
MC - 350 C2 (HD)	1100 X 580	1240 X 720	70	40	BS - EN 124

(SAUDI TELECOM CO.)

Heavy Duty Grey Cast Iron Multiple Covers with Mild Steel Angle Frames

Features:-

- Galvanized Steel Frame use 50 X 50 X 5mm
- Closed Key Holes
- Removable "T" Bar
- Cover Size 646 X 646mm
- Fish Tail Anchors

Options:-

- Locking System Two Nos on Each Cover

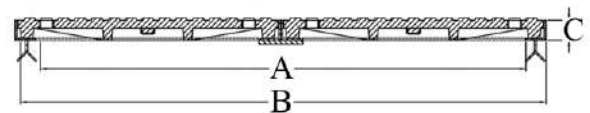
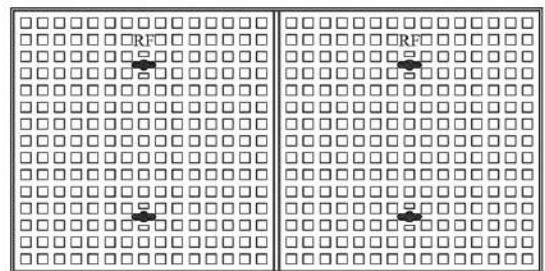

Product Code	Clear Opening A (mm)	Over Base B (mm)	Depth C (mm)	Loading (TONS)	Specifications
MC - 646 X 646 C2 (HD)	1223 X 560	1323 X 660	50	40	BS - EN 124



(SAUDI TELECOM CO.)

Light, Medium and Heavy Duty Grey Cast Iron Multiple Covers with Mild Steel Angle Frames

Features:-

- Galvanized Steel Frame 50 X 50 X 5mm
- Closed Key Holes
- Prising Slots
- Cover Sizes 680 X 680, 684 X 684 and 690 X 690mm
- Removable "T" Bar

Options:-

- 2 Nos Locking System each Cover

Heavy Duty

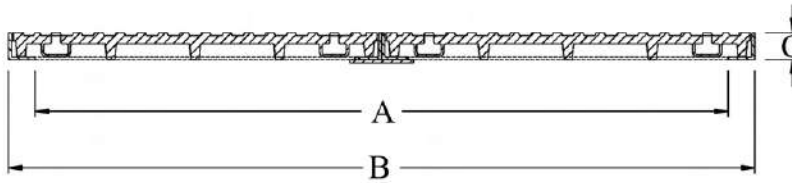
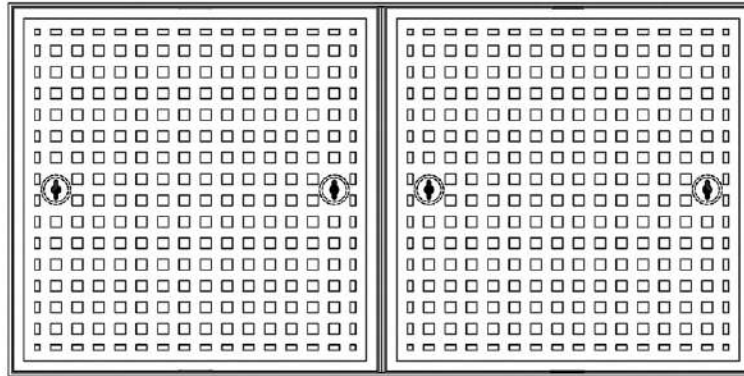

Product Code	Clear Opening A (mm)	Over Base B (mm)	Depth C (mm)	Loading (TONS)	Specifications
MC - 680 X 680 C2 (LD)	1290 X 595	1390 X 695	50	1.5	BS - EN 124
MC - 680 X 680 C2 (MD)	1290 X 595	1390 X 695	50	12.5	BS - EN 124
MC - 680 X 680 C2 (HD)	1290 X 595	1390 X 695	50	40	BS - EN 124
MC - 684 X 684 C2 (LD)	1300 X 600	1400 X 700	50	1.5	BS - EN 124
MC - 684 X 684 C2 (MD)	1300 X 600	1400 X 700	50	12.5	BS - EN 124
MC - 684 X 684 C2 (HD)	1300 X 600	1400 X 700	50	40	BS - EN 124
MC - 690 X 690 C2 (LD)	1310 X 605	1410 X 705	50	1.5	BS - EN 124
MC - 690 X 690 C2 (MD)	1310 X 605	1410 X 705	50	12.5	BS - EN 124
MC - 690 X 690 C2 (HD)	1310 X 605	1410 X 705	50	40	BS - EN 124



(SAUDI TELECOM CO.)

Light Medium and Heavy Duty Grey Cast Iron Multiple Covers with Mild Steel Angle Frames (Slow moving traffic only)

Features:-

- Galvanized Steel Frame
- Closed Key Holes
- Cover Size 600 X 700
- Two Prising Slots on Each Cover
- Removable "T" Bar
- Fish Tail Anchors
- Angle Frame Used 70 X 70 X 7mm

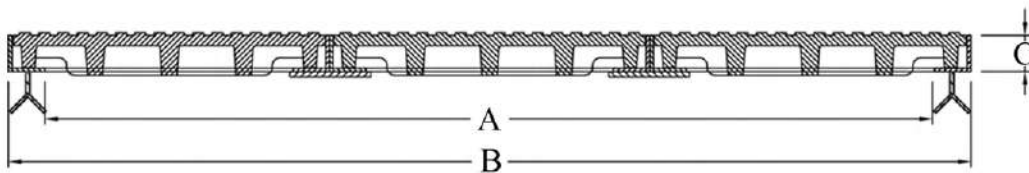
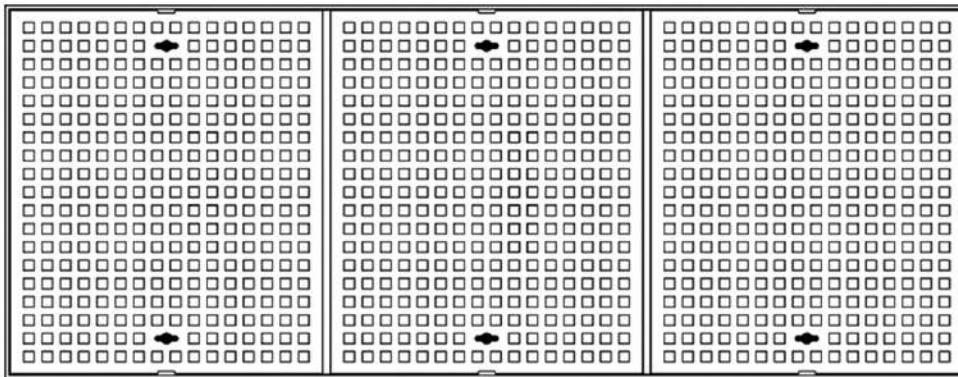

Product Code	Clear Opening A (mm)	Over Base B (mm)	Depth C (mm)	Loading (TONS)	Specifications
MC - 350 C3 (LD)	1720 X 580	1860 X 720	70	1.5	BS - EN 124
MC - 350 C3 (MD)	1720 X 580	1860 X 720	70	12.5	BS - EN 124
MC - 350 C3 (HD)	1720 X 580	1860 X 720	70	40	BS - EN 124



(SAUDI TELECOM CO.)

Light Medium and Heavy Duty Grey Cast Iron Multiple Covers with Mild Steel Angle Frames (Slow moving traffic only)

Features:-

- Galvanized Steel Frame use 50 X 50 X 5mm
- Closed Key Holes
- Prising Slots
- Cover Sizes 680 X 680, 684 X 684 and 690 X 690mm
- Removable "T" Bar

Options:-

- 2 Nos Locking System each Cover

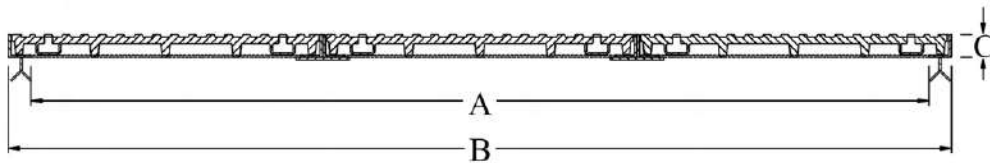
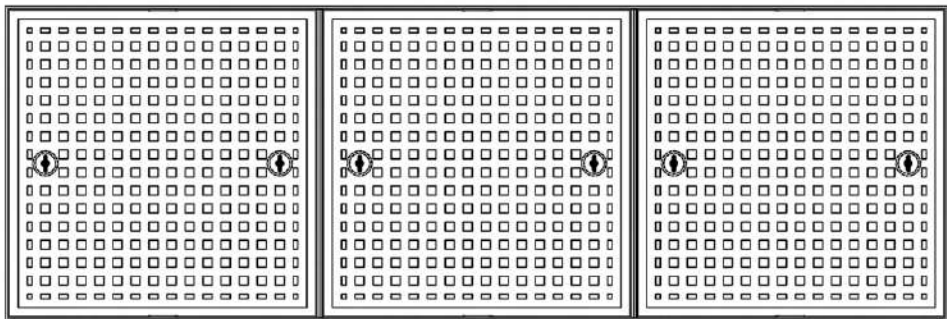

Product Code	Clear Opening A (mm)	Over Base B (mm)	Depth C (mm)	Loading (TONS)	Specifications
MC - 680 X 680 C3 (LD)	1985 X 595	2085 X 695	50	1.5	BS - EN 124
MC - 680 X 680 C3 (MD)	1985 X 595	2085 X 695	50	12.5	BS - EN 124
MC - 680 X 680 C3 (HD)	1985 X 595	2085 X 695	50	40	BS - EN 124
MC - 684 X 684 C3 (LD)	2000 X 600	2100 X 700	50	1.5	BS - EN 124
MC - 684 X 684 C3 (MD)	2000 X 600	2100 X 700	50	12.5	BS - EN 124
MC - 684 X 684 C3 (HD)	2000 X 600	2100 X 700	50	40	BS - EN 124
MC - 690 X 690 C3 (LD)	2015 X 605	2115 X 705	50	1.5	BS - EN 124
MC - 690 X 690 C3 (MD)	2015 X 605	2115 X 705	50	12.5	BS - EN 124
MC - 690 X 690 C3 (HD)	2015 X 605	2115 X 705	50	40	BS - EN 124



(SAUDI TELECOM CO.)

Heavy Duty Grey Cast Iron Covers with Mild Steel Angle Frames

Features:-

- Galvanized Steel Frame Use 50 X 50 X 5mm
- Closed Key Holes
- Cover Depth 45mm
- Fish Tail Anchors

Options:-

- Locking System Two Nos on Each Cover

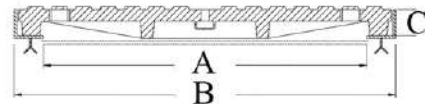
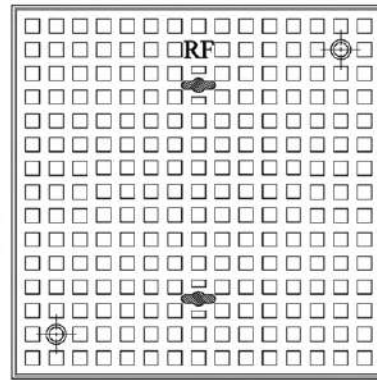

Product Code	Cover Size	Clear Opening A (mm)	Over Base B (mm)	Depth C (mm)	Loading (TONS)	Specifications
MC - 700 X 700 C1 (HD)	700 X 700	615 X 615	715 X 715	50	40	BS - EN 124

(SAUDI TELECOM CO.)

Heavy Duty Grey Cast Iron Multiple Covers with Mild Steel Angle Frames

Features:-

- Galvanized Steel Frame use 50 X 50 X 5mm
- Closed Key Holes
- Removable "T" Bar
- Cover Size 700 X 700mm
- Fish Tail Anchors

Options:-

- Locking System Two Nos on Each Cover

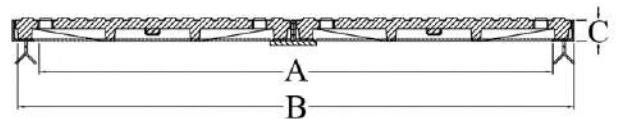
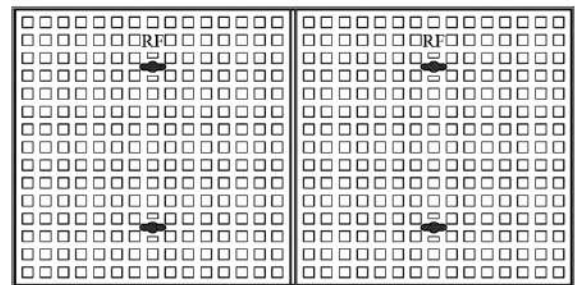

Product Code	Clear Opening A (mm)	Over Base B (mm)	Depth C (mm)	Loading (TONS)	Specifications
MC - 700 X 700 C2 (HD)	1330 X 615	1430 X 715	50	40	BS - EN 124



JORDAN TELECOMMUNICATIONS

Medium and Heavy Duty Grey Cast Iron Covers and Steel Frames

Features:-

- Closed Key Holes
- Foundation Bolt Base Plate
- Steel Frame 60 X 60 X 6mm

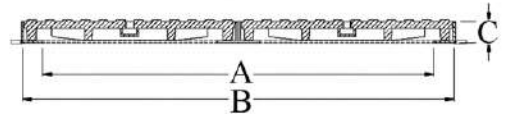
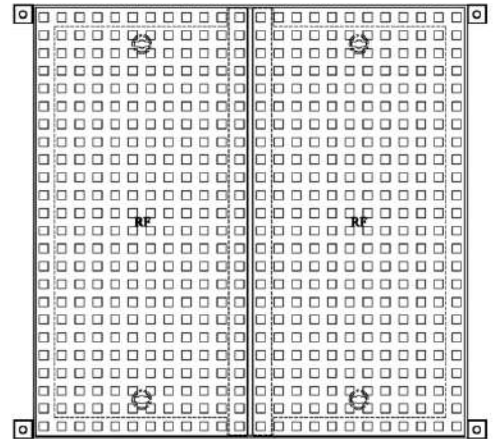
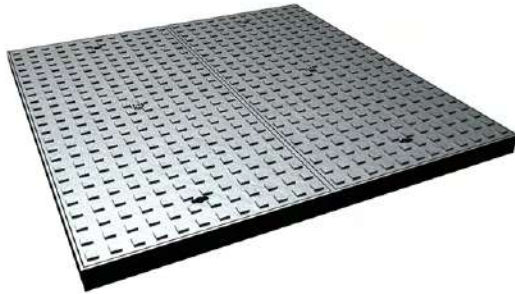

Product Code	Clear Opening A (mm)	Over Base B (mm)	Depth C (mm)	Loading (TONS)	Specifications
MC - 100 X 90 C2 JTC (MD)	1000 X 900	1120 X 1020	60	15	BS - EN 124
MC - 100 X 90 C2 JTC (HD)	1000 X 900	1120 X 1020	60	35	BS - EN 124

JORDAN TELECOMMUNICATIONS

Medium and Heavy Duty Grey Cast Iron Covers and Mild Steel Angle Frames

Features:-

- Closed Key Holes
- Angle Frame 60 X 60 X 6mm
- Foundation Bolt Base Plate

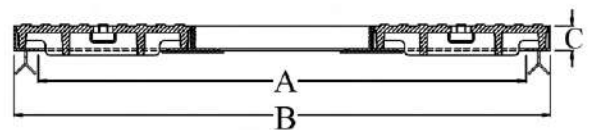
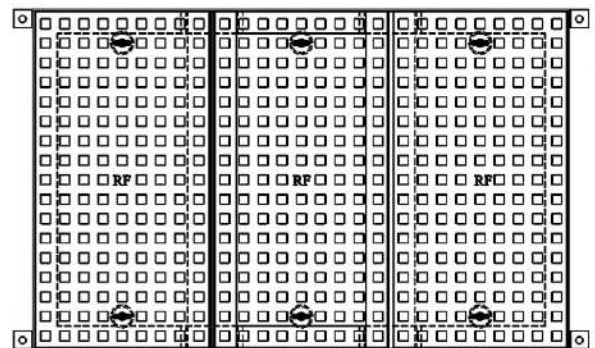

Product Code	Clear Opening A (mm)	Over Base B (mm)	Depth C (mm)	Loading (TONS)	Specifications
MC - 155 X 90 JTC C3 (MD)	1550 X 900	1670 X 1020	60	15	BS - EN 124
MC - 155 X 90 JTC C3 (HD)	1550 X 900	1670 X 1020	60	35	BS - EN 124

JORDAN TELECOMMUNICATIONS

Heavy Duty Ductile Cast Iron Covers and Frames

Features:-

- Prising Slots
- Closed Key Holes
- Slots for Foundation Hole

Options:-

- Available for Grey Cast Iron

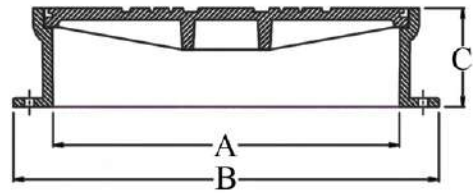
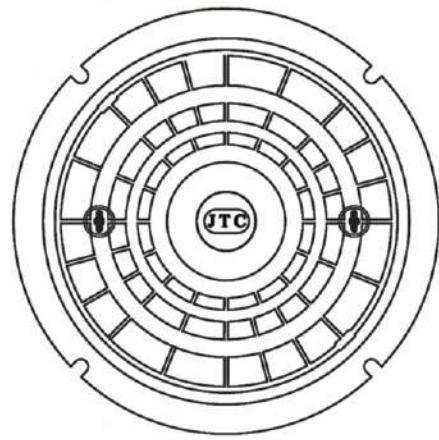

Product Code	Clear Opening A (mm)	Over Base B (mm)	Depth C (mm)	Loading (TONS)	Specifications
MC - 120 JTC DI (HD)	760Ø	900Ø	150	40	BS - EN 124

JORDAN TELECOMMUNICATIONS

Medium and Heavy Duty Grey Cast Iron Covers and Mild Steel Angle Frames

Features:-

- Closed Key Holes
- Angle Frame 60 X 60 X 6mm
- Foundation Bolt Base Plate

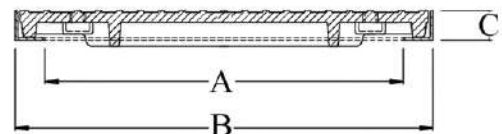
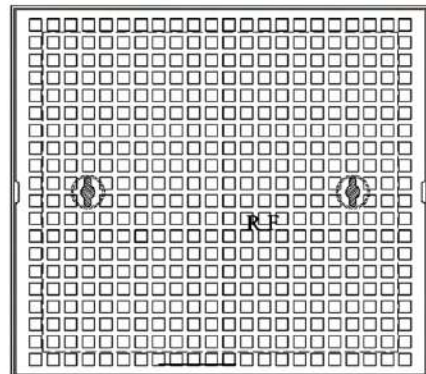

Product Code	Clear Opening A (mm)	Over Base B (mm)	Depth C (mm)	Loading (TONS)	Specifications
MC - 68 X 48 C1 JTC (HD)	577 X 377	697 X 497	60	35	BS - EN 124
MC - 68 X 48 C1 JTC (MD)	577 X 377	697 X 497	60	15	BS - EN 124



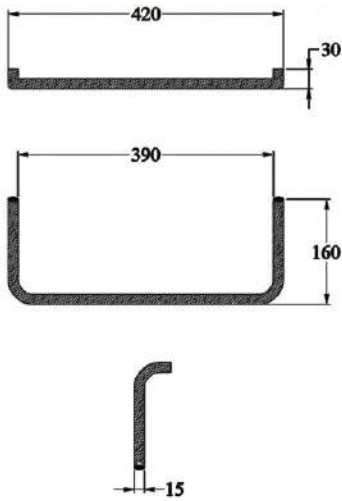

LADDER SUPPORT

Ladder Support Used to Hold Ladder Inside the Chamber

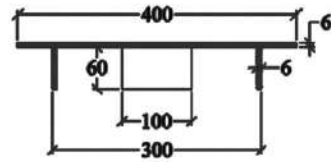
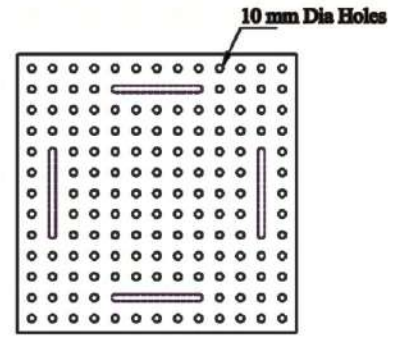

SUMP PIT COVERS

The Manhole Sump Grid made of Mild Steelis used to Cover Manhole Sump Pits, Support a Point Load of 100 Kg

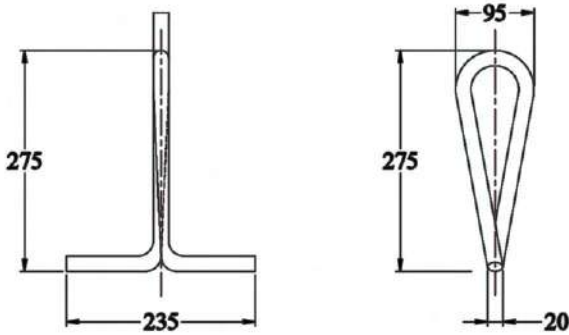

PULLING EYES

Used for pulling Cables through the Duct

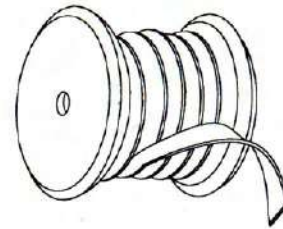

BONDING RIBBON

The Bonding Ribbon Is an Annealed Solid Copper Ribbon

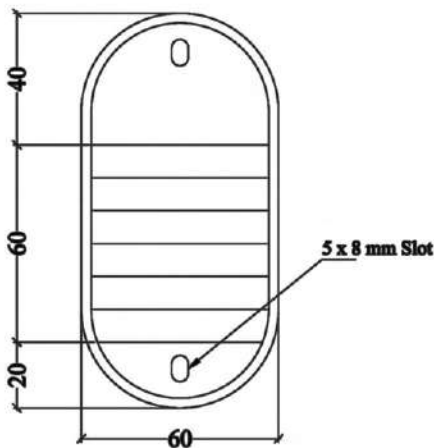

MARKING PLATE

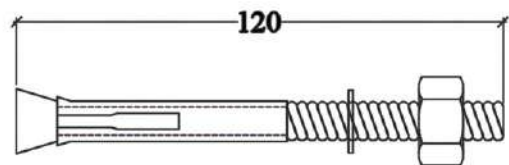

ANCHOR BOLT

10mm Dia Expansion Bolt with Washer

CABLE BRACKET SUPPORTS

- Bracket Support Mounted In side the Chamber Wall to hold Cable Brackets
- Brackets are used Inside the Chamber to carry Telecommunication Cables

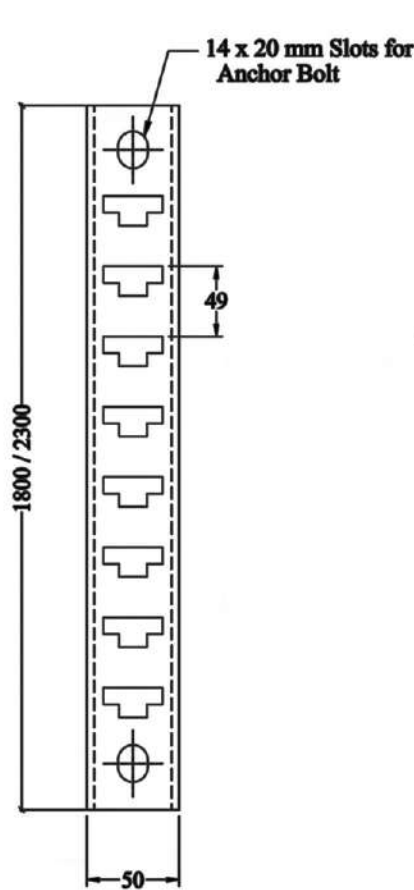

Front Elevation

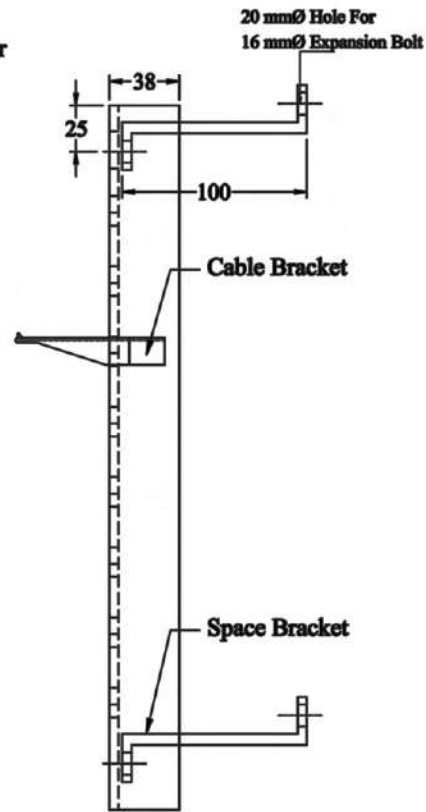

Side View

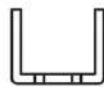

Top View

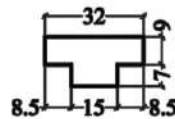

Slot Details

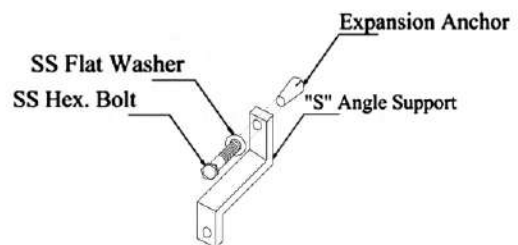
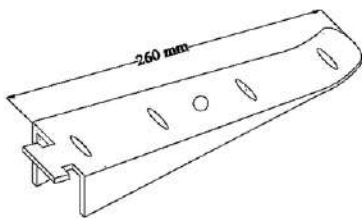

Cable Bracket Length	A
250mm	
350mm	
450mm	



HOOK LADDER

Features:-

- Hot Dip Galvanized According to ASTM 123

Material:-

- Conforming to ASTM A36

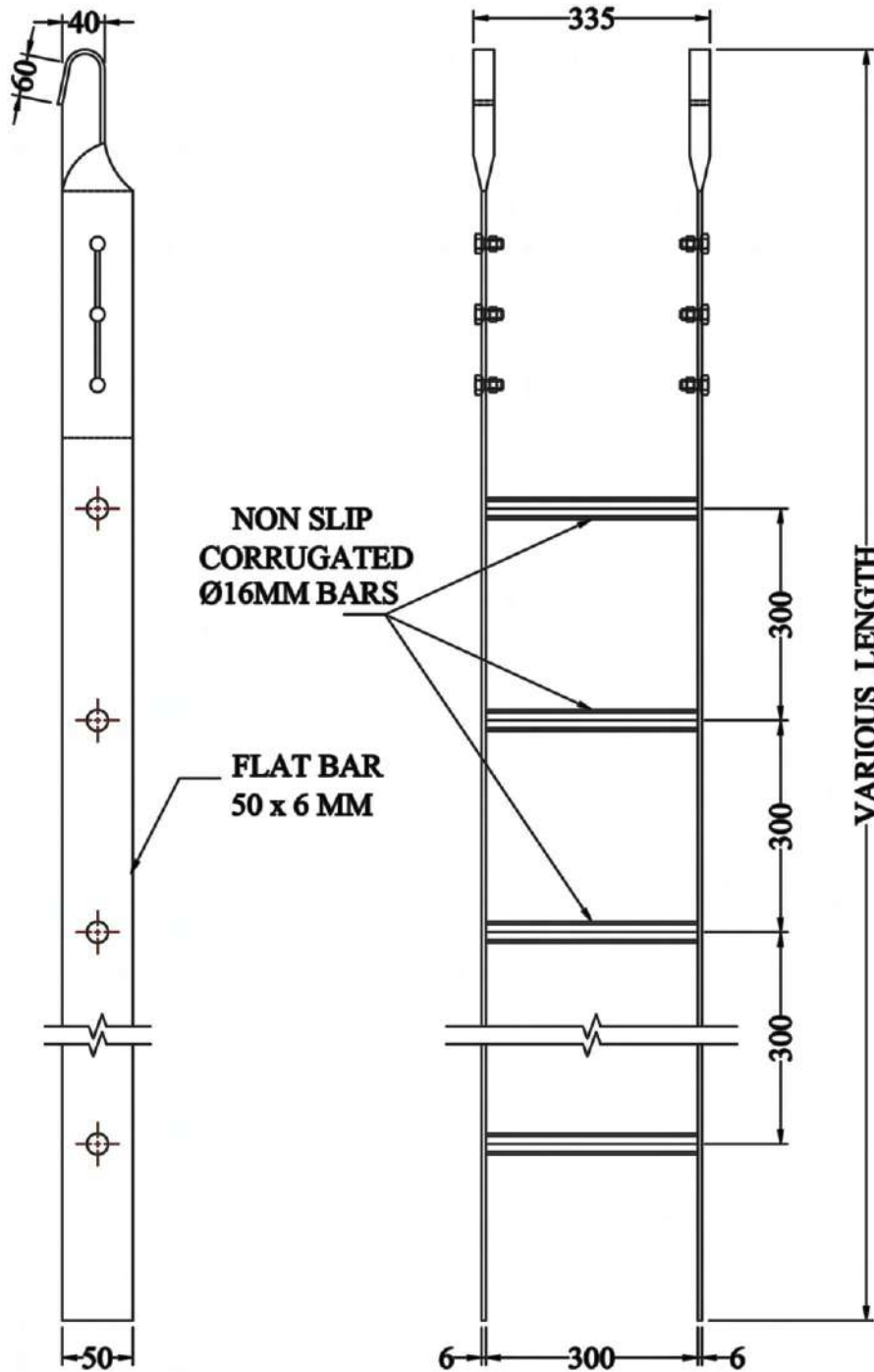

BRONZE PLAQUE

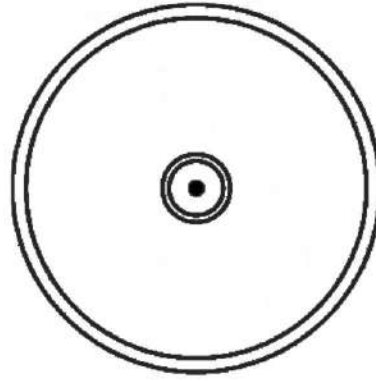

Extension Ring for MC - 120 A HD

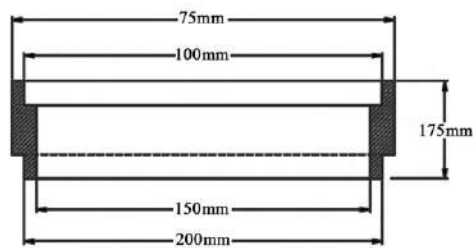
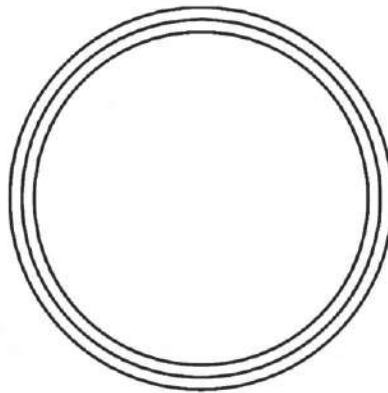



APPROVALS

MINISTRY OF WATER AND ELECTRICITY

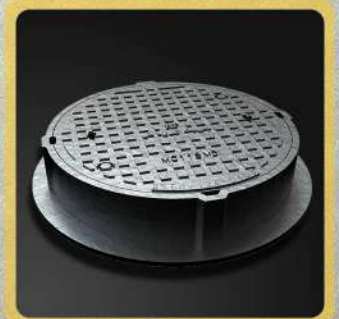

WATER AUTHORITY - RIYADH

Heavy Duty Grey Cast Iron Surface Box

Features:-

- Lifting Handle
- Cover Chain to Frame by Stainless Steel Chain

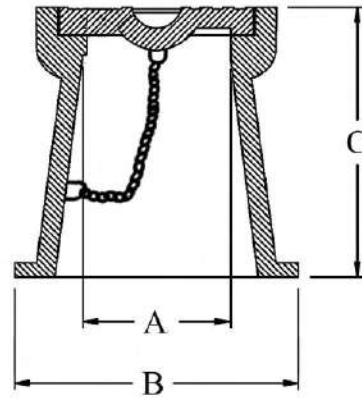
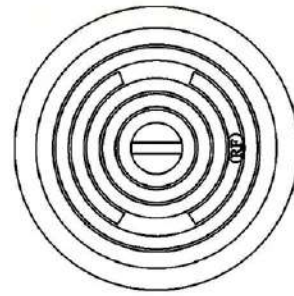

Product Code	Clear Opening A (mm)	Over Base B (mm)	Bottom Opening (mm)	Depth C (mm)	Specifications
SB - 600 (HD)	120Ø	200Ø	132Ø	300	Heavy Duty BS - 5834

WATER AUTHORITY - RIYADH

Heavy Duty Grey Cast Iron Cover and Frames

Features:-

- Lifting Handle
- Locking Bar
- Stainless Steel Chain

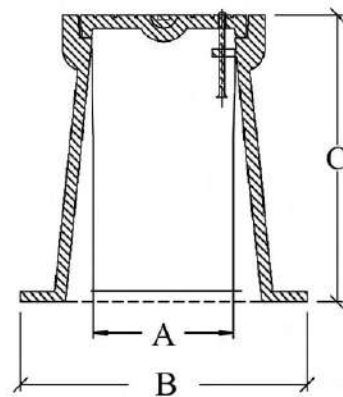
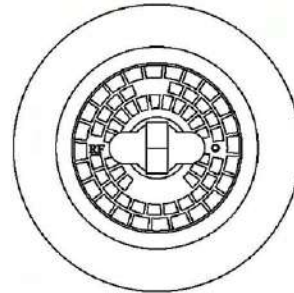

Product Code	Clear Opening A (mm)	Over Base B (mm)	Depth C (mm)	Specifications
SB - 620 R3 (HD)	140Ø	270Ø	270	Heavy Duty BS - 5834

SEWER PROJECT - EASTERN PROVINCE

Heavy Duty Grey Cast Iron Surface Box

Features:-

- Lifting Handle
- Stainless Steel Chain

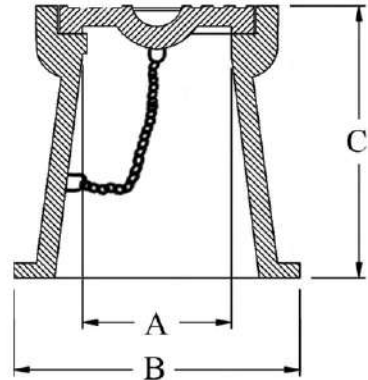
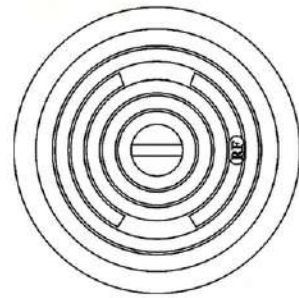

Product Code	Clear Opening A (mm)	Over Base B (mm)	Depth C (mm)	Specifications
SB - 600 (HD)	120 Ø	200 Ø	300	Heavy Duty BS - 5834

SEWER PROJECT - RIYADH

Heavy Duty Grey Cast Iron Clean Out Surface Box

Features:-

- One Open Key Hole
- One 10mm Vent Holes
- Cover Chained to Box by Stainless Steel Chain
- Two Locking Legs

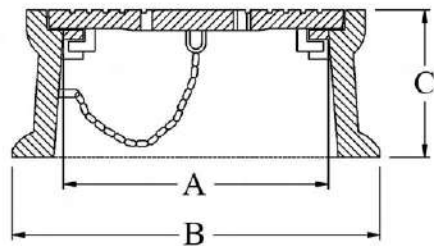
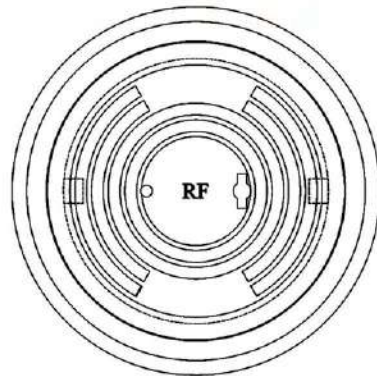

Product Code	Clear Opening A (mm)	Over Base B (mm)	Depth C (mm)	Specifications
SB - 631 R1 (HD)	280 Ø	370 Ø	140	Heavy Duty - BS - 5834

SEWER PROJECT - EASTERN PROVINCE

Heavy Duty Grey Cast Iron Surface Box

Features:-

- Lifting Bar
- Cover chain to frame

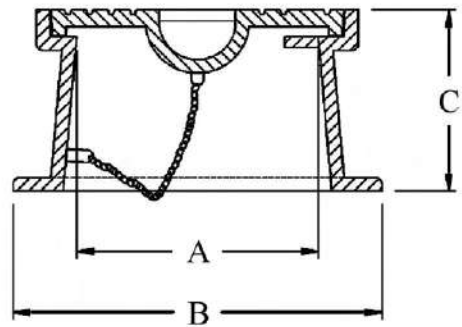
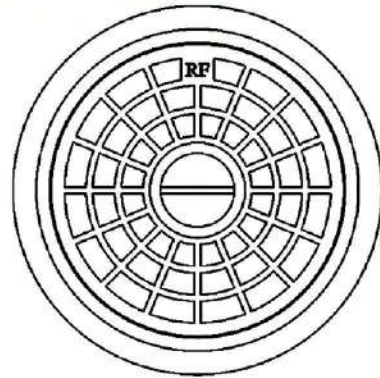

Product Code	Clear Opening A (mm)	Over Base B (mm)	Depth C (mm)	Specifications
SB - 621 (HD)	300Ø	400Ø	200	Heavy Duty BS - 5834

SEWER PROJECT - RIYADH

Heavy Duty Grey Cast Iron Clean Out Surface Box

Features:-

- One Open Key Hole
- One 10mm Vent Holes
- Cover Chained to Box by Stainless Steel Chain
- Two Locking Legs

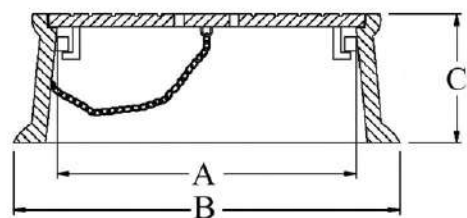
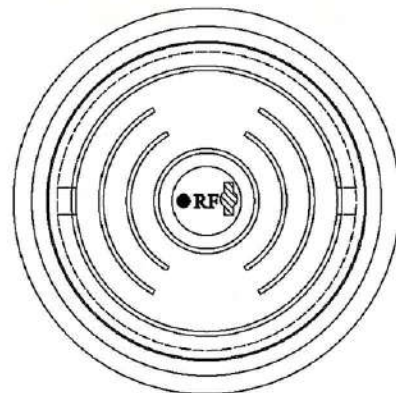

Product Code	Clear Opening A (mm)	Over Base B (mm)	Depth C (mm)	Specifications
SB - 631 AR1 (HD)	330Ø	420Ø	140	Heavy Duty - BS - 5834



Medium Duty Grey Cast Iron Cover and Frames

Features:-

- Closed Key Holes
- Prising Slots
- Locking Bolts
- Register

Options:-

- Single Seal

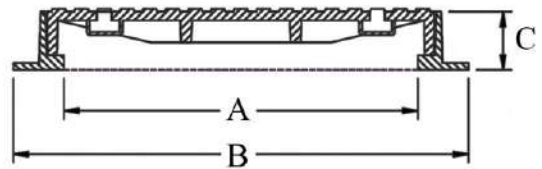
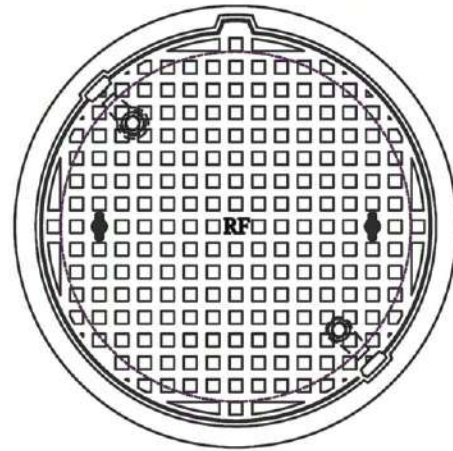

Product Code	Clear Opening A (mm)	Over Base B (mm)	Depth C (mm)	Loading (TONS)	Specifications
MC - 105 (MD)	600Ø	780Ø	100	12.5	BS - EN 124

SEWER PROJECT - RIYADH

Heavy Duty Grey Cast Iron Covers and Frames

Features:-

- Open Key Holes
- Two Stainless Steel Locking Bolts
- Round Rubber Gasket
- Three Prising Slots

Options:-

- Closed Key Holes
- Galvanized Bolt

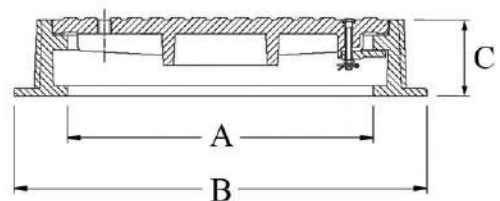
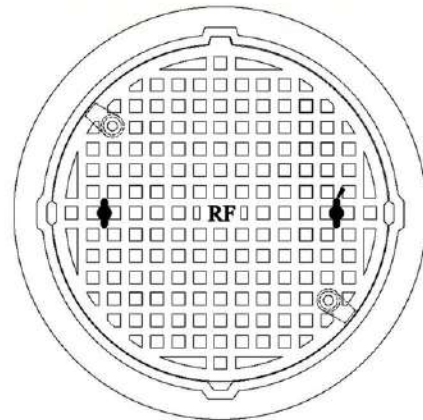

Product Code	Clear Opening A (mm)	Over Base B (mm)	Depth C (mm)	Loading (TONS)	Specifications
MC - 115 (HD)	600Ø	810Ø	150	40	BS - EN 124

Heavy Duty Grey Cast Iron Covers and Frames

Features:-

- Locking Bolts
- Prising Slots
- Register
- Closed Key Holes

Options:-

- Single Seal

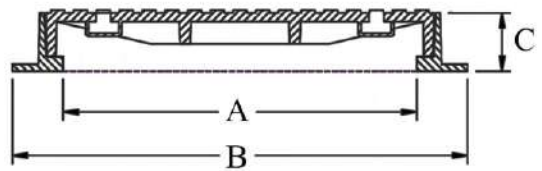
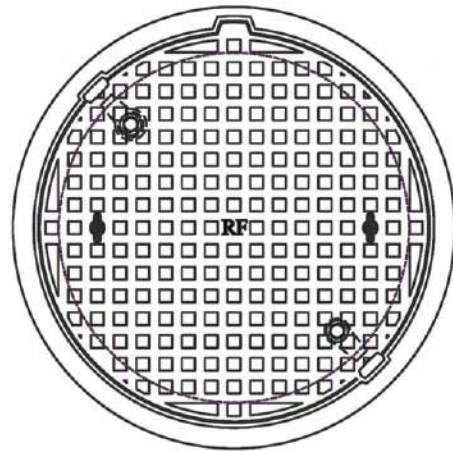

Product Code	Clear Opening A (mm)	Over Base B (mm)	Depth C (mm)	Loading (TONS)	Specifications
MC - 105 (HD)	600Ø	780Ø	100	40	BS - EN 124

SEWER PROJECT - EASTERN PROVINCE

Heavy Duty Grey Cast Iron Covers and Frames

Features:-

- Open Key Holes
- Register
- Three Prising Slots
- Four Ventilation Holes
- Round Rubber Gasket

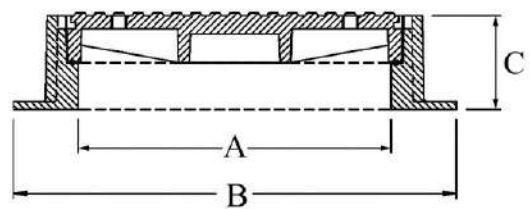
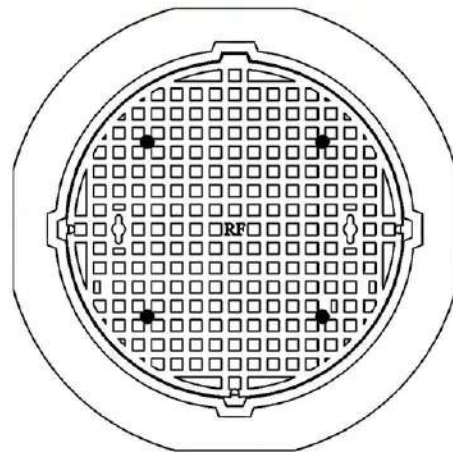

Product Code	Clear Opening A (mm)	Over Base B (mm)	Depth C (mm)	Loading (TONS)	Specifications
MC - 110 (HD)	600Ø	850Ø	180	40	BS - EN 124



WATER AUTHORITY - RIYADH

Heavy Duty Grey Cast Iron Covers and Frames

Features:-

- Three Prising Slots
- Two Open Key Holes
- One Register
- Two Stainless Steel Locking Bolts

Options:-

- Closed Key Holes

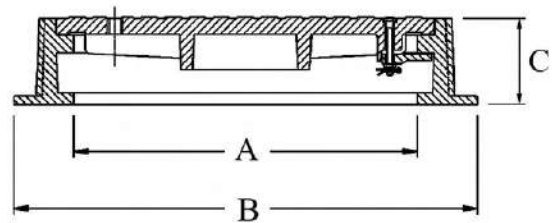
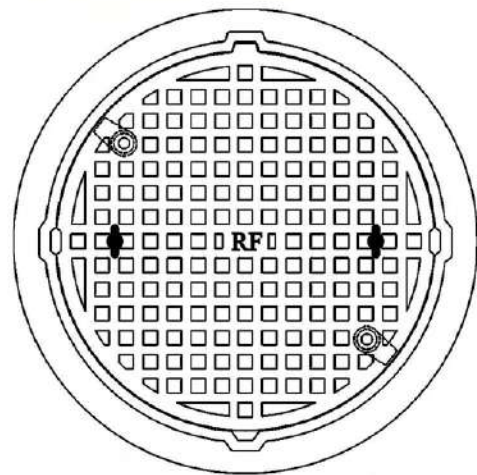

Product Code	Clear Opening A (mm)	Over Base B (mm)	Depth C (mm)	Loading (TONS)	Specifications
MC - 115 (HD)	600Ø	810Ø	150	40	BS - EN 124

Heavy Duty Grey Cast Iron Multiple Covers with Single Frames

Features:-

- Two Closed Key Holes
- Single Seal

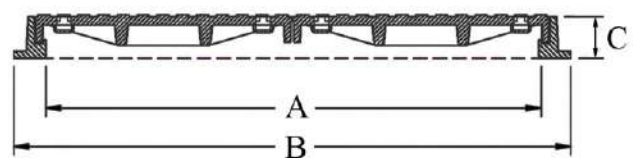
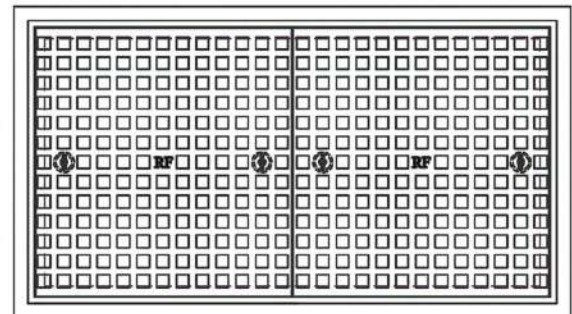

Product Code	Clear Opening A (mm)	Over Base B (mm)	Depth C (mm)	Loading (TONS)	Specifications
MC - 354 (HD)	1200 X 600	1360 X 750	100	40	BS - EN 124

WATER AUTHORITY - RIYADH

Heavy Duty Grey Cast Iron Covers and Mild Steel Frames - (Slow moving traffic only)

Features:-

- Two Closed Key Holes for each Cover
- Epoxy Coated Frames
- Angle Frame Used 70 X 70 X 7mm

Options:-

- Closed Key Holes
- Hot Dip Galvanized Frame

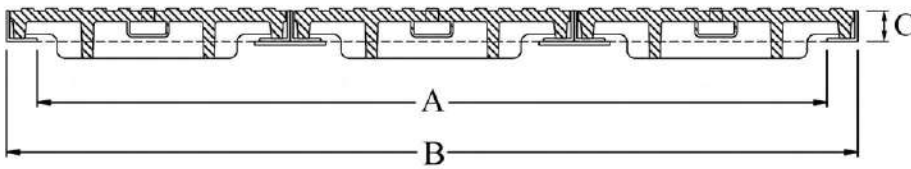
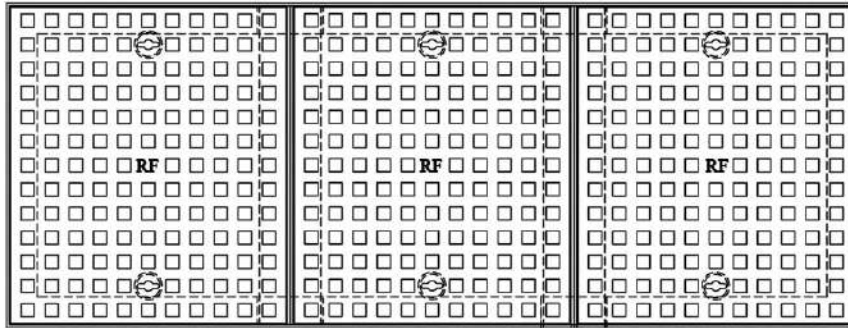

Product Code	Clear Opening A (mm)	Over Base B (mm)	Depth C (mm)	Loading (TONS)	Specifications
MC - 180 X 60 C3 (HD)	1800 X 600	1940 X 740	70	40	BS - EN 124



RIYADH FOUNDRY



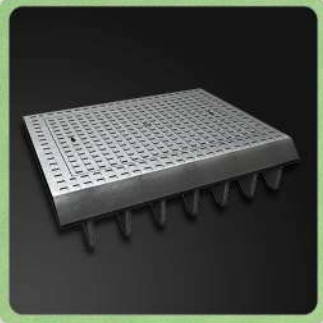
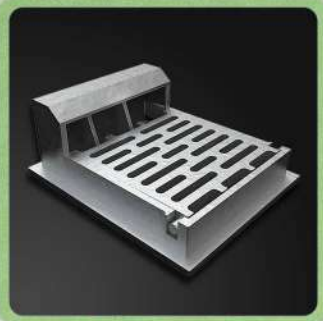
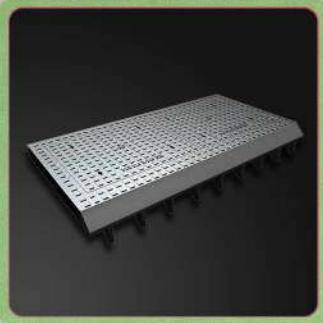

**APPROVALS
MUNICIPALITY**

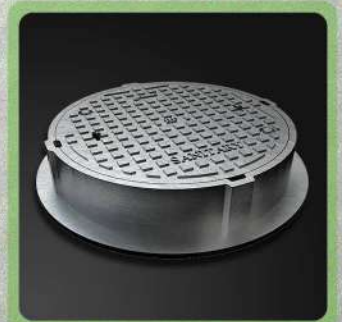
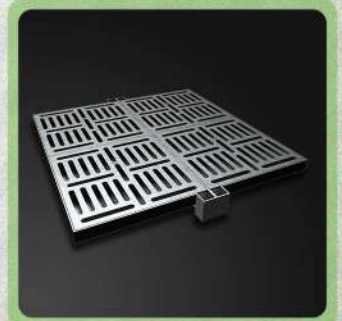

MUNICIPALITY - RIYADH
Heavy Duty Grey Cast Iron Covers and Frames

Features:-

- Two Open Key Holes
- Two Stainless Steel Locking Bolts
- Three Prising Slots
- One Register

Options:-

- Closed Key Holes

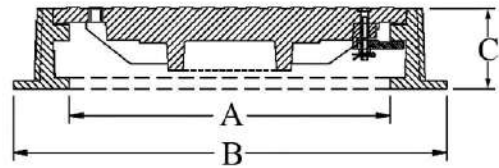
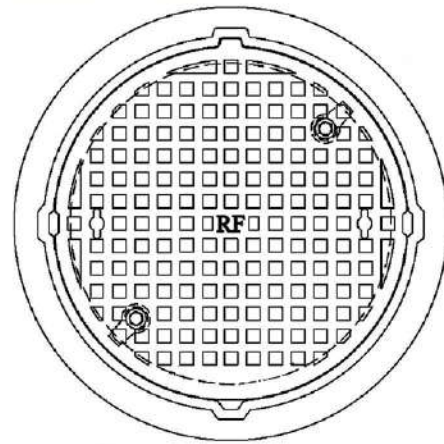

Product Code	Clear Opening A (mm)	Over Base B (mm)	Depth C (mm)	Loading (Tons)	Specifications
MC - 115 (HD)	600Ø	810Ø	150	40	BS - EN 124

MUNICIPALITY - RIYADH
Heavy Duty Grey Cast Iron Grates and Frames

Features:-

- Hinged Grating

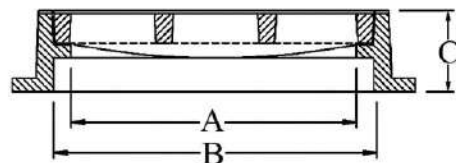
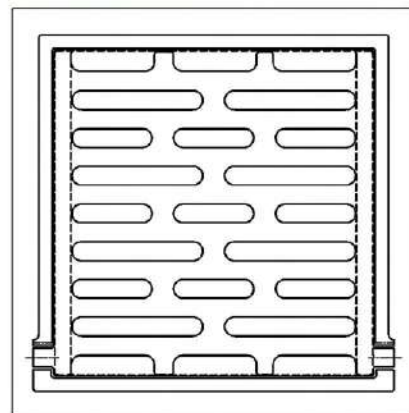

Product Code	Clear Opening A (mm)	Over Base B (mm)	Depth C (mm)	Loading (Tons)	Specifications
MC - 475 R1 M (HD)	600 X 530	750Sq	150	25	BS - EN 124



Grey Cast Iron (Class C 250)
Inspection Chamber Cover and Kerb Gully Frame

Features:-

- 4 Nos Closed Key Holes

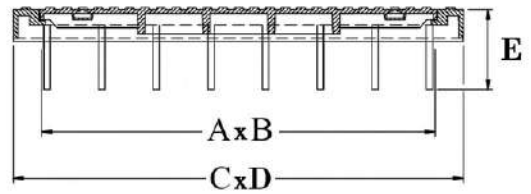
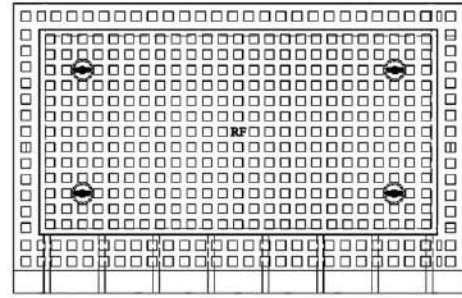

Product Code	Clear Opening A X B (mm)	Over Base C X D (mm)	Depth E (mm)	Loading (Tons)	Specifications
MC - 315 R M4 (HD)	1200 X 600	1400 X 900	250	25	BS - EN 124

Heavy Duty Ductile Iron (Class D 400)
Double Grates with Mild Steel Angle Frame

Features:-

- Galvanized Steel Frame
- Removable "T" Bar and "I" Beam
- Beam Housing Box
- Angle Frame 70 X 70 X 7mm

Options:-

- Black Epoxy Coated Frame

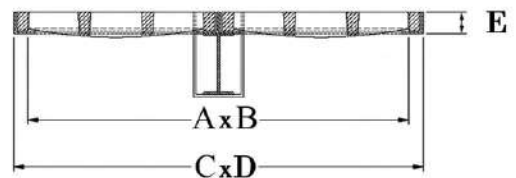
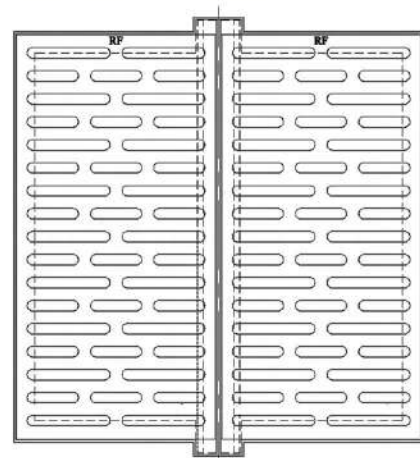

Product Code	Clear Opening A X B (mm)	Over Base C X D (mm)	Depth E (mm)	Loading (Tons)	Specifications
MC - 120 X 120 DI G2 M40 HD / 70	1200 X 1200	1340 X 1340	70 / 278	40	BS - EN 124

Grey Cast Iron (Class C 250)
Inspection Chamber Cover and Kerb Gully Frame

- Features:-**
 - 4 Nos closed key holes on each cover

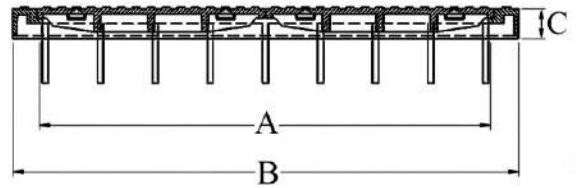
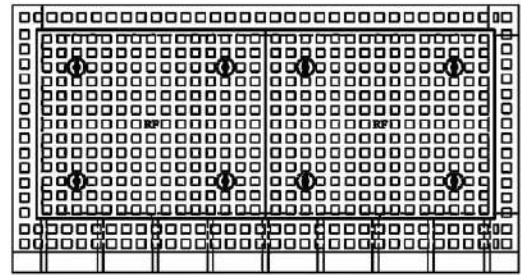

Product Code	Clear Opening A (mm)	Over Base B (mm)	Depth C (mm)	Loading (Tons)	Specifications
MC - 315 R M5 (HD)	1500 X 600	1700 X 900	250	25	BS - EN 124

Heavy Duty Ductile Iron (Class C 250)
Grates with Mild Steel Angle Frame

- Features:-**
- Galvanized Steel Frame
 - Removable "T" Bar and "I" Beam
 - Beam Housing Box
 - Angle Frame 80 X 80 X 8mm
- Options:-**
- Black Epoxy Coated Frame

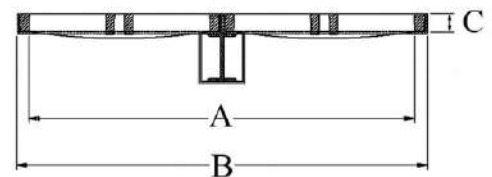
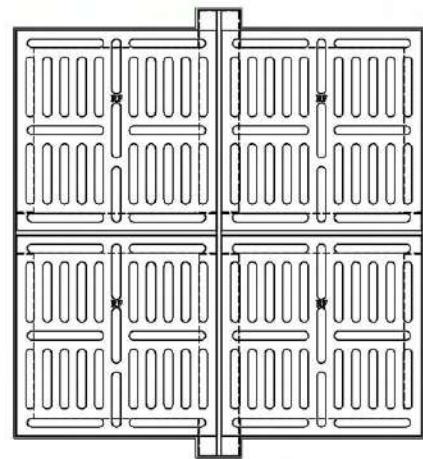

Product Code	Clear Opening A (mm)	Over Base B (mm)	Depth C (mm)	Loading (Tons)	Specifications
MC - 150 X 150 DI G4 HD	1500 X 1500	1660 X 1660	80 / 388	25	BS - EN 124

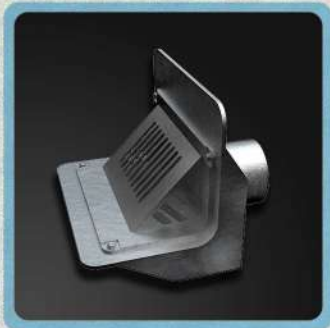
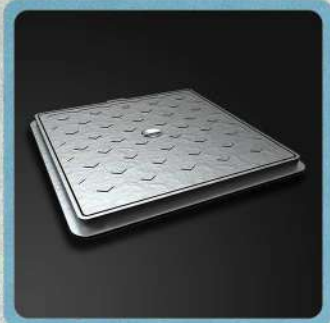
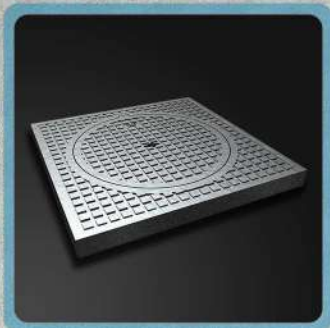

APPROVALS
MINISTRY OF EDUCATION



BOYS SCHOOL

Light Duty Grey Cast Iron Covers and Frames

Features:-

- Register
- Lifting Bar
- Single Seal

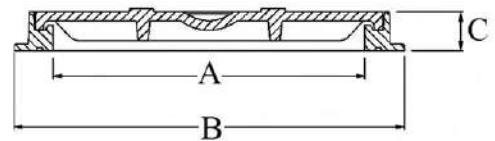
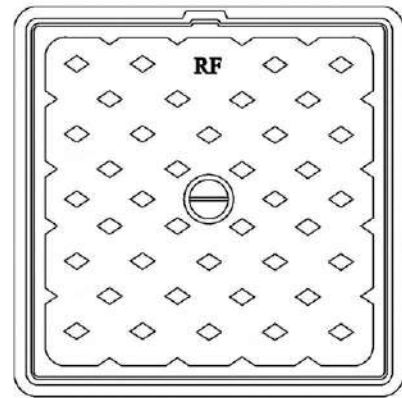

Product Code	Clear Opening A (mm)	Over Base B (mm)	Depth C (mm)	Loading (Tons)	Specifications
MC - 203 (LD)	300Sq	400Sq	30	1.5	BS - EN 124

BOYS SCHOOL

Light Duty Grey Cast Iron Covers and Frames

Features:-

- Register
- Double Seal
- Lifting Handle

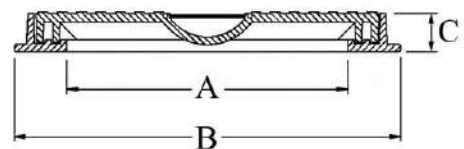
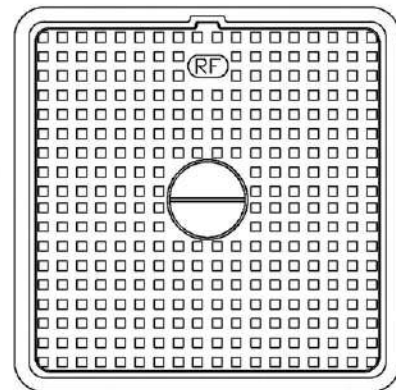

Product Code	Clear Opening A (mm)	Over Base B (mm)	Depth C (mm)	Loading (Tons)	Specifications
MC - 203 R4 (LD)	300Sq	460Sq	40	1.5	BS - EN 124

BOYS SCHOOL

Medium Duty Grey Cast Iron Covers and Frames

Features:-

- Closed Key Holes
- Rubber Seal
- Two Prising Slots
- Register

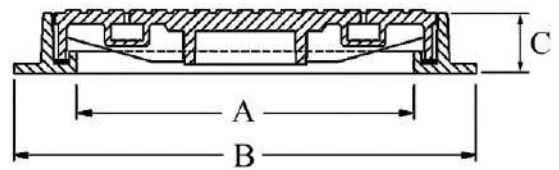
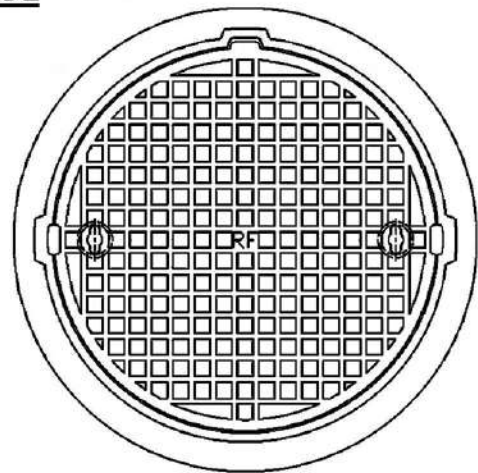

Product Code	Clear Opening A (mm)	Over Base B (mm)	Depth C (mm)	Loading (Tons)	Specifications
MC - 118 (MD)	600Ø	750Ø	75	12.5	BS - EN 124

BOYS SCHOOL

Light Duty Grey Cast Iron Covers and Frames

Features:-

- Register
- Safety Grid
- Safety Grid Secured to Frames
- Safety Grid Hinged to Frames
- Closed Key Holes

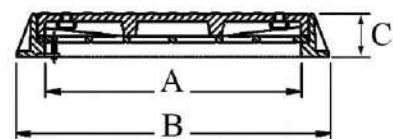
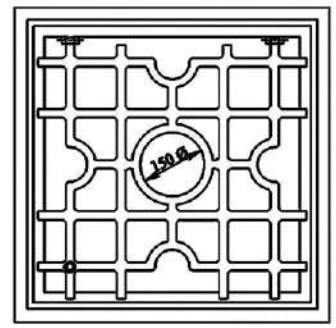
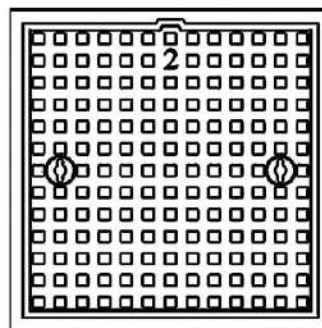

Product Code	Clear Opening A (mm)	Over Base B (mm)	Depth C (mm)	Loading (Tons)	Specifications
MC - 210 SG R2 (LD)	600Sq	700Sq	75	1.5	BS - EN 124

BOYS SCHOOL

SCUPPER DRAIN

Grey Cast Iron Body with Aluminium Grates and Flashing Collars

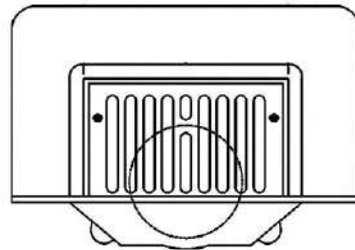
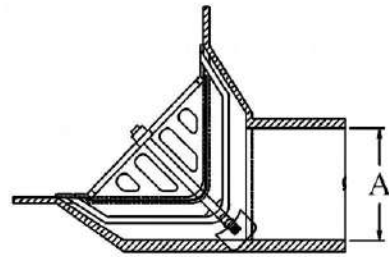

Product Code	Outlet (ID) A (mm)
RF - SD - 506	3 "Ø
RF - SD - 506 - 50	2 "Ø
RF - SD - 506 - 75	3 "Ø
RF - SD - 506 - 100	4 "Ø

BOYS SCHOOL

ROOF DRAIN

Heavy Duty Grey Cast Iron Body / Aluminium Dome

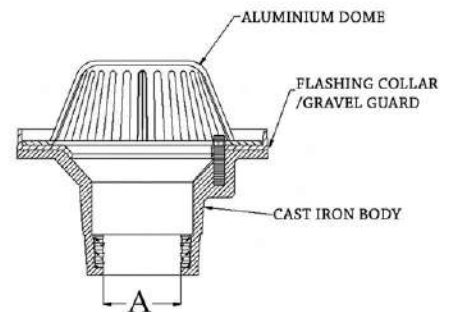
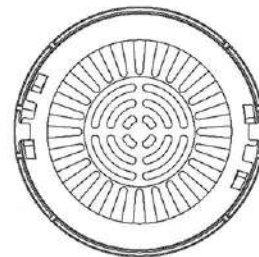

Product Code	Outlet (ID) A (mm)
RF - RD - 613 - 50	(2")
RF - RD - 613 - 75	(3")
RF - RD - 613 - 100	(4")
RF - RD - 613 - 150	(6")
RF - RD - 613 - 200	(8")

BOYS SCHOOL

FLOOR DRAIN

Material : Brass

Finish : Chrome Polished

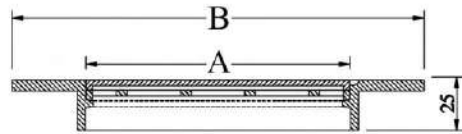
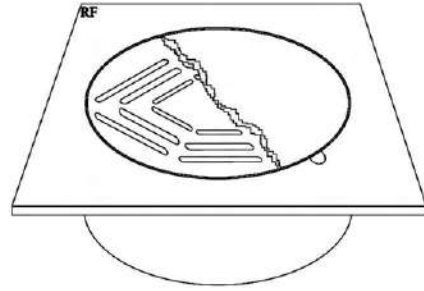

Product Code	Outlet Size (A)	Over Base (B)
RF - FDC - 702	110Ø	150Sq

BOYS SCHOOL

CLEAN OUT

Material : Brass

Finish : Chrome Polished

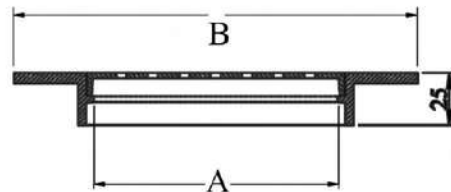
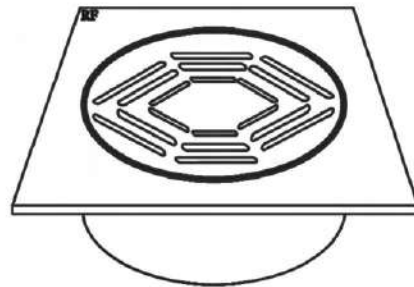

Product Code	Outlet Size (A)	Over Base (B)
RF - FD - 801	110Ø	150Sq

GIRLS SCHOOL

Light Duty Grey Cast Iron Covers and Frames

Features:-

- Single Seal
- Closed Key Holes

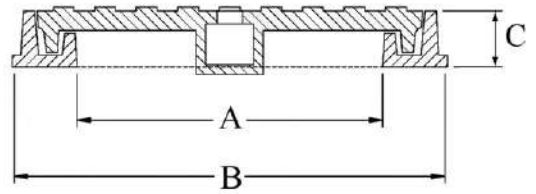
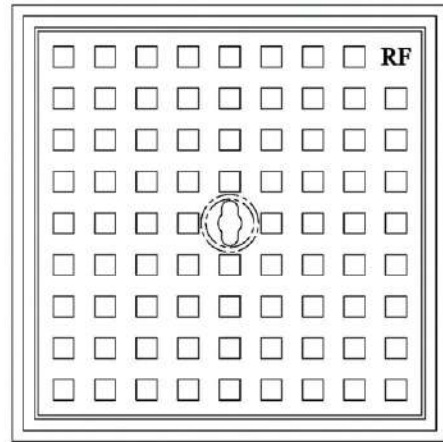

Product Code	Clear Opening A (mm)	Over Base B (mm)	Depth C (mm)	Loading (Tons)	Specifications
MC - 200 R (LD)	250Sq	320Sq	30	1.5	BS - EN 124

GIRLS SCHOOL

Medium Duty Grey Cast Iron Grates and Frames

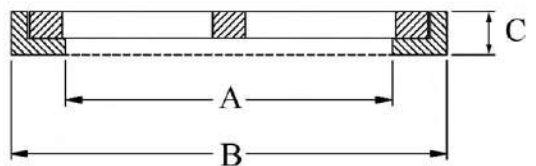
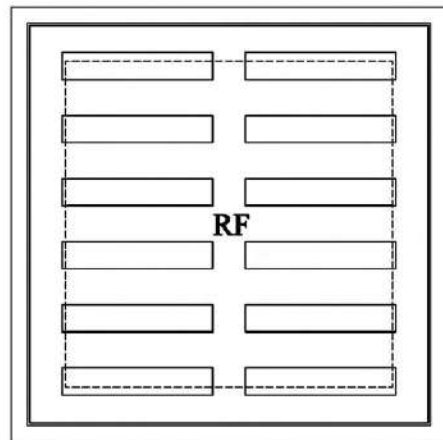

Product Code	Clear Opening A (mm)	Over Base B (mm)	Depth C (mm)	Loading (Tons)	Specifications
MC - 443 (MD)	300Sq	400Sq	40	12.5	BS - EN 124



GIRLS SCHOOL

Light Duty Grey Cast Iron Covers and Frames

Features:-

- Closed Key Holes

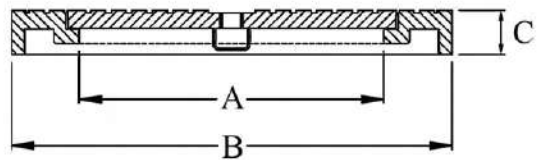
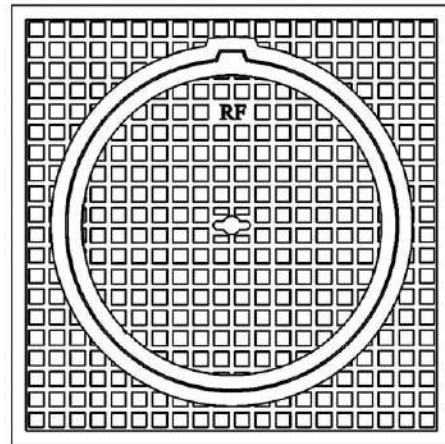

Product Code	Clear Opening A (mm)	Over Base B (mm)	Depth C (mm)	Loading (Tons)	Specifications
MC - 171 (LD)	415Ø	600Sq	60	1.5	BS - EN 124

GIRLS SCHOOL

Medium Duty Grey Cast Iron Covers and Frames

Features:-

- Closed Key Holes
- Register
- Safety Grid
- Safety Grid Secured to Frame
- Safety Grid Hinged to Frame

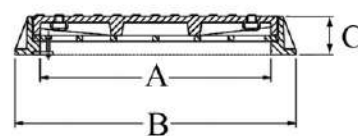
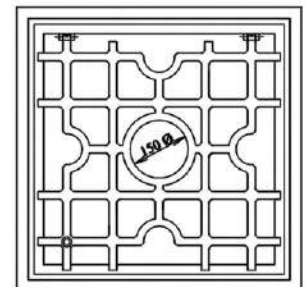
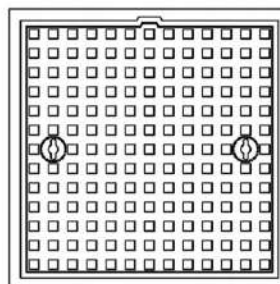

Product Code	Clear Opening A (mm)	Over Base B (mm)	Depth C (mm)	Loading (Tons)	Specifications
MC - 210 SG R2 (MD)	600Sq	750Sq	100	12.5	BS - EN 124

GIRLS SCHOOL

SCUPPER DRAIN

Grey Cast Iron Body with Aluminium Grates and Flashing Collars

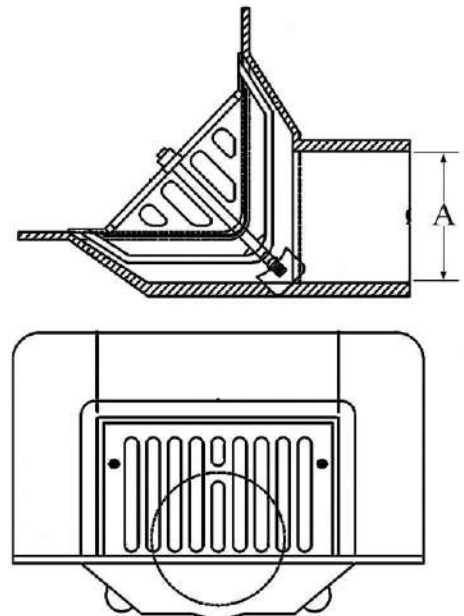

Product Code	Outlet (ID) A (mm)
RF - SD - 506	3 "Ø
RF - SD - 506 - 50	2 "Ø
RF - SD - 506 - 75	3 "Ø
RF - SD - 506 - 100	4 "Ø

GIRLS SCHOOL

ROOF DRAIN

Heavy Duty Grey Cast Iron Body / Aluminium Dome

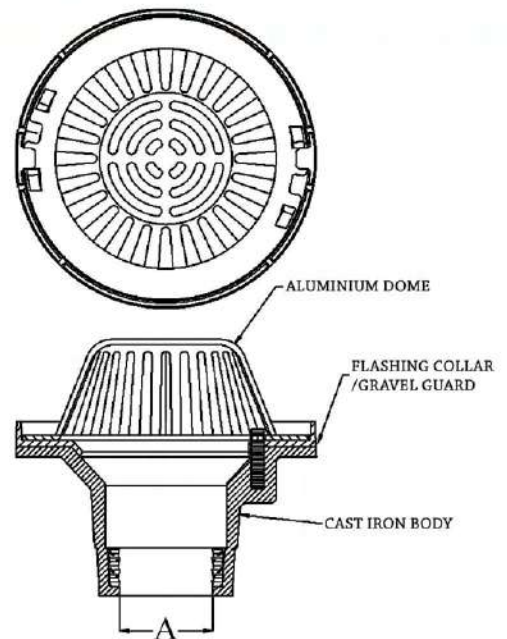

Product Code	Outlet (ID) A (mm)
RF - RD - 613 - 50	(2")
RF - RD - 613 - 75	(3")
RF - RD - 613 - 100	(4")
RF - RD - 613 - 150	(6")
RF - RD - 613 - 200	(8")

GIRLS SCHOOL

FLOOR DRAIN

Material : Brass

Finish : Chrome Polished

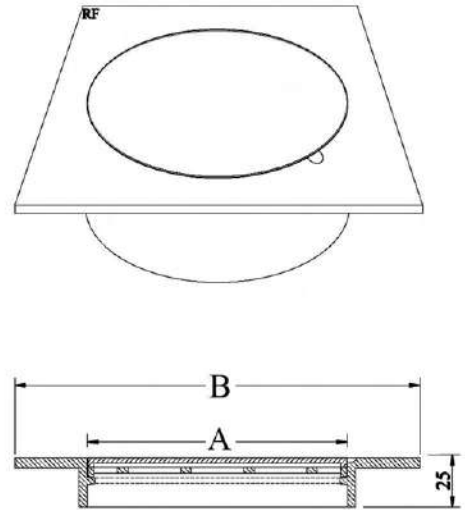

Product Code	Outlet Size (A)	Over Base (B)
RF - FDC - 702 - 11	110Ø	150Sq

GIRLS SCHOOL

MILD STEEL BRACKET TYPE ACCESS LADDER

Finish : Hot Dip Galvanized

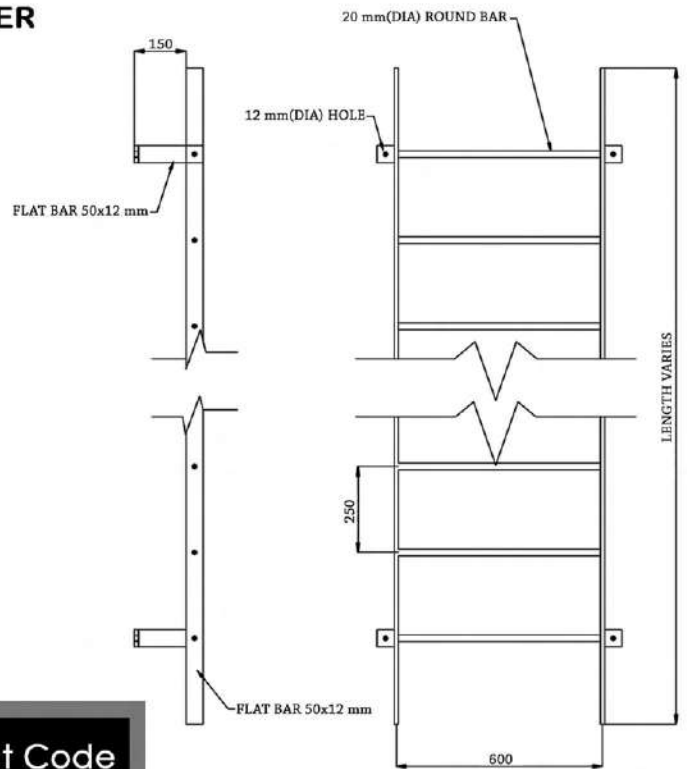

Product Code
AL - 60 W



DRAINAGE PRODUCTS



ROOF DRAIN

Heavy Duty Grey Cast Iron Body / Aluminium Dome

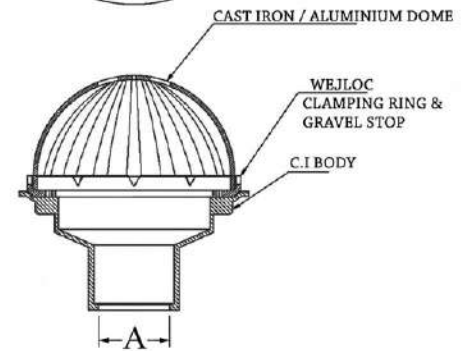
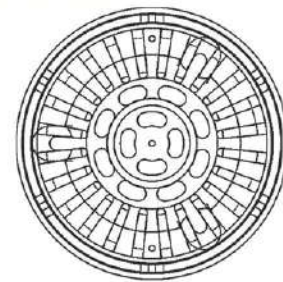

Product Code	Outlet (ID) A (mm)
RF - RD - 50	66 Ø (2")
RF - RD - 75	90 Ø (3")
RF - RD - 100	118 Ø (4")
RF - RD - 125	172 Ø (6")

Heavy Duty Grey Cast Iron Body / Aluminium Dome

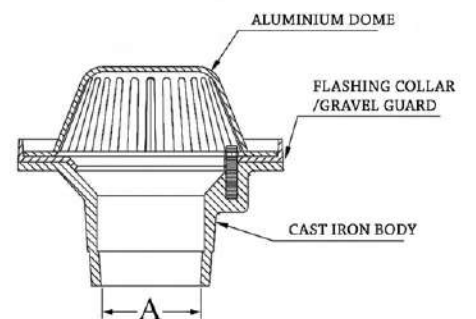
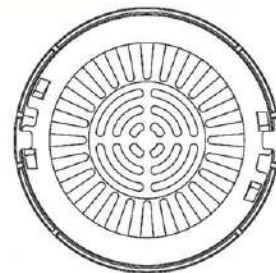

Product Code	Outlet (ID) A (mm)
RF - RD - 613 - 50	66 Ø (2")
RF - RD - 613 - 75	90 Ø (3")
RF - RD - 613 - 100	118 Ø (4")
RF - RD - 613 - 150	172 Ø (6")
RF - RD - 613 - 200	200 Ø (8")

Heavy Duty Grey Cast Iron Body / Aluminium Dome

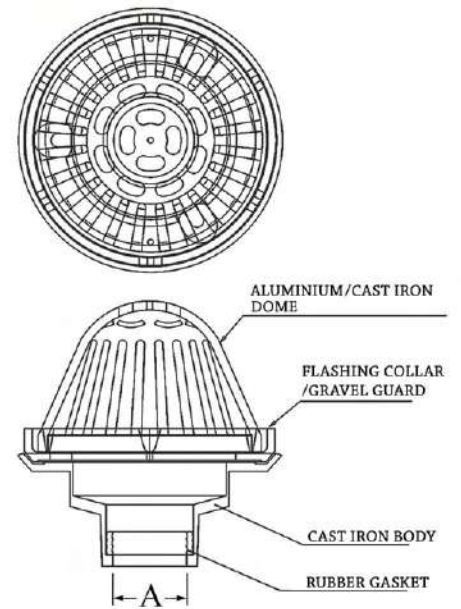

Product Code	Outlet (ID) A (mm)
RF - RD - 620 - 50	66 Ø (2")
RF - RD - 620 - 75	90 Ø (3")
RF - RD - 620 - 100	118 Ø (4")
RF - RD - 620 - 150	172 Ø (6")

ADJUSTABLE ROOF DRAIN

Grey Cast Iron Body with Grey Cast Iron / Aluminium Dome

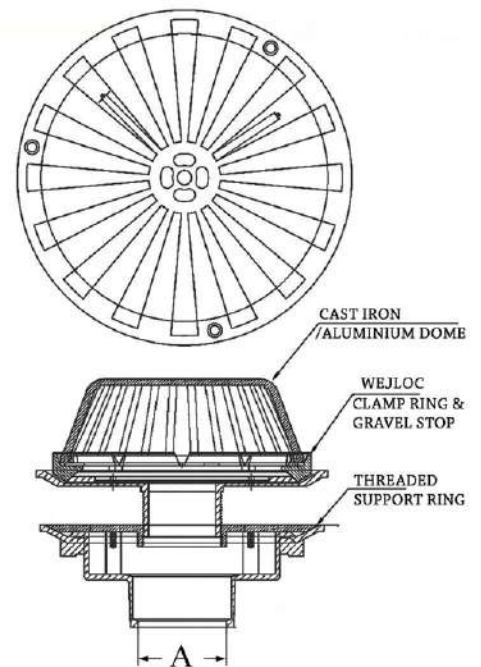

Product Code	Outlet (ID) A (mm)
RF - RD - 625 - 50	66 Ø (2")
RF - RD - 625 - 75	90 Ø (3")
RF - RD - 625 - 100	118 Ø (4")
RF - RD - 625 - 150	172 Ø (6")

ROOF DRAIN - DOME

Grey Cast Iron / Aluminium Roof Drain - Dome

- This Designe Suitable for any other Roof Drains according to Customer request and Dimensions

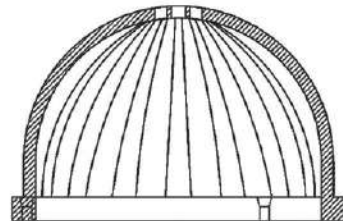
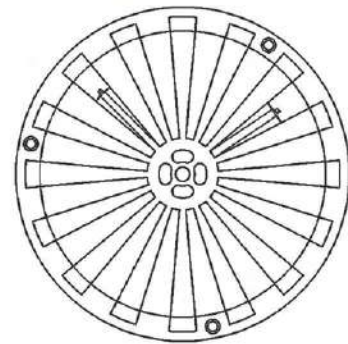

Product Code

RF - RD - 626

FLOOR DRAIN

Grey Cast Iron Adjustable Floor Drain with Bronze, Square, Strainer

Features:-

- Lid Secured to the Frame by 6mmØ Screw

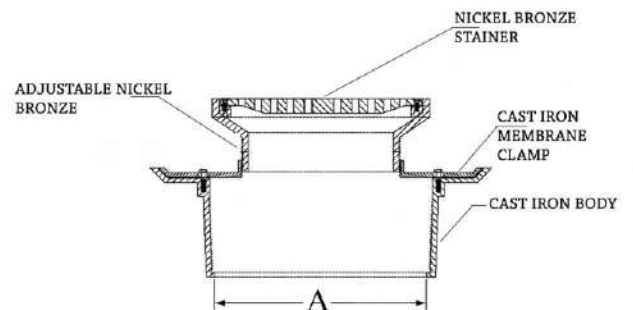
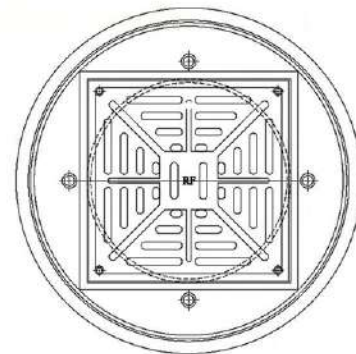

Product Code

Outlet (ID)
A (mm)

RF / CO - 150 / 75
RF / CO - 150 / 110

75 Ø
110 Ø



Heavy Duty Grey Cast Iron Floor Drain

Specifications:-

- Grey Cast Iron Heavy Duty Drains with Tractor Grate with Flashing Collor

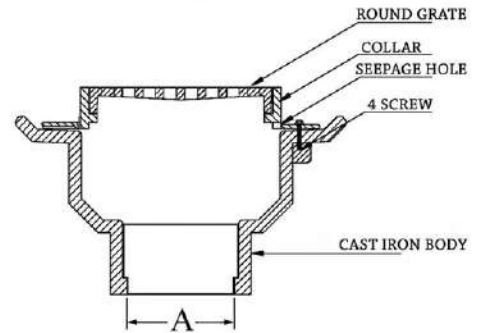
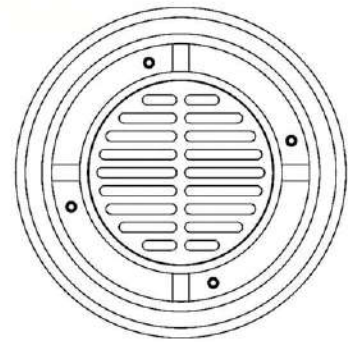

Product Code	Outlet (ID) A (mm)
RF - FD - 400 - 2	66 Ø (2")
RF - FD - 400 - 3	90 Ø (3")
RF - FD - 400 - 4	118 Ø (4")
RF - FD - 400 - 6	172 Ø (6")

Grey Cast Iron Floor Drain

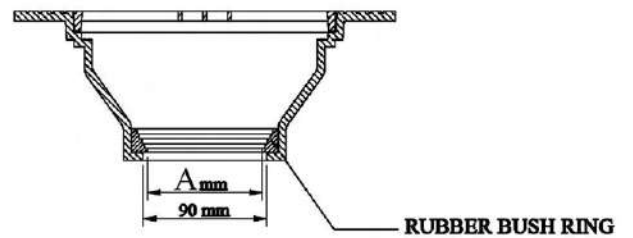
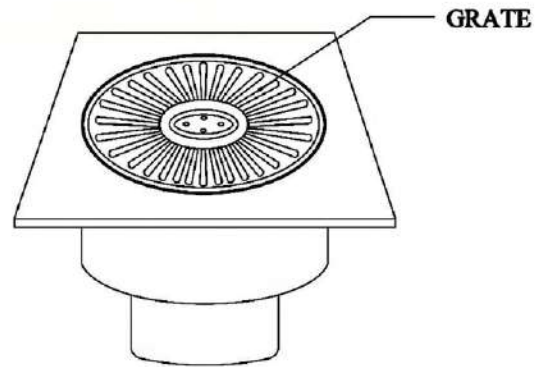

Product Code	Outlet (ID) A (mm)
RF - FD - 410 - 78	78 Ø
RF - FD - 410 - 2	66 Ø (2")
RF - FD - 410 - 3	90 Ø (3")

FLOOR DRAIN

Grey Cast Iron Floor Drain (Planting Area Drain)

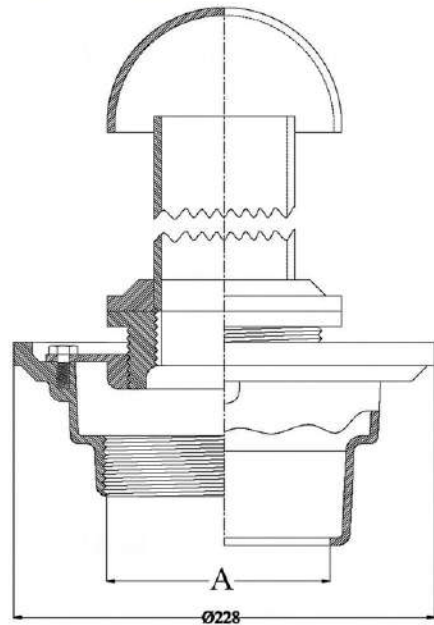

Product Code	Outlet (ID) A (mm)
RF - FD - 420 - 50	50 Ø (2")
RF - FD - 420 - 75	75 Ø (3")
RF - FD - 420 - 100	100 Ø (4")

Grey Cast Iron Floor Drain

Specifications:-

- Grey Cast Iron Drain Body
- Threaded Reversible Grey Cast Iron Collor secured to the Body
- Grey Cast Iron Threaded Flashing Clamp for Grate
- Brass Finished Secured Square Open Grate
- Grey Cast Iron Collor Provided with Seepage Slots and Weep Holes
- Adjustable Minimum Position 20mm and Maximum Position 50mm

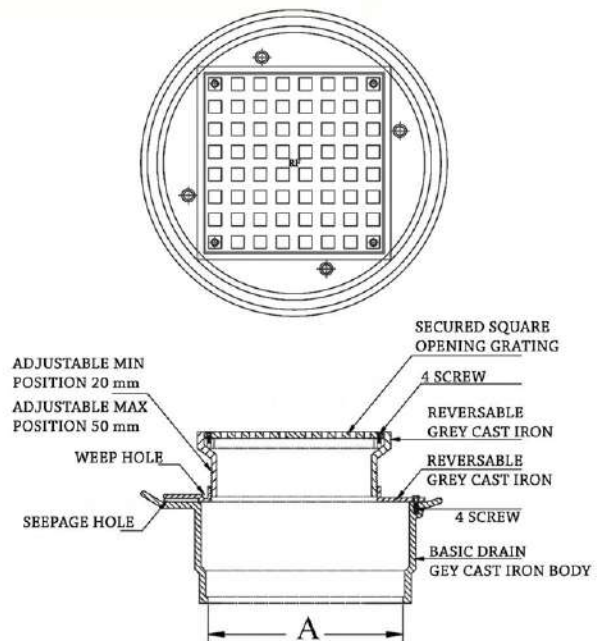

Product Code	Outlet (ID) A (mm)
RF - FD - 1011 - S2	66 Ø (2")
RF - FD - 1011 - S3	90 Ø (3")
RF - FD - 1011 - S4	118 Ø (4")
RF - FD - 1011 - S6	172 Ø (6")

Grey Cast Iron Floor Clean Out

Specifications:-

- Round Adjustable Soriated Secured Brass
- Machine Finished Top Cover and Close Plug

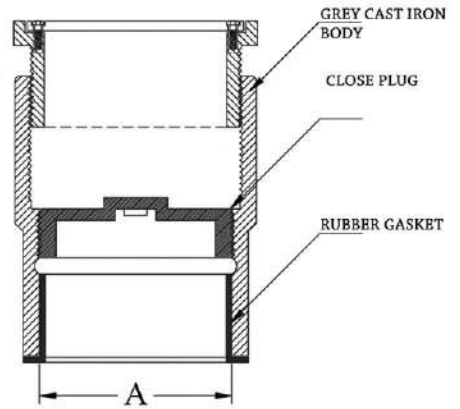
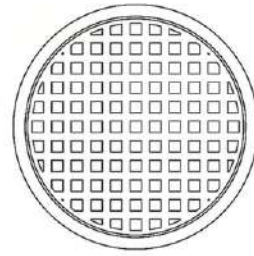

Product Code	Outlet (ID) A (mm)
RF - FCO - 1201 - S2	66Ø (2")
RF - FCO - 1201 - S3	90Ø (3")
RF - FCO - 1201 - S4	118Ø (4")
RF - FCO - 1201 - S6	172Ø (6")

Grey Cast Iron Floor Drain

FLOOR DRAIN

Material : Brass
Finish : Chrome Coated

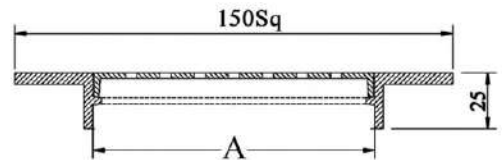
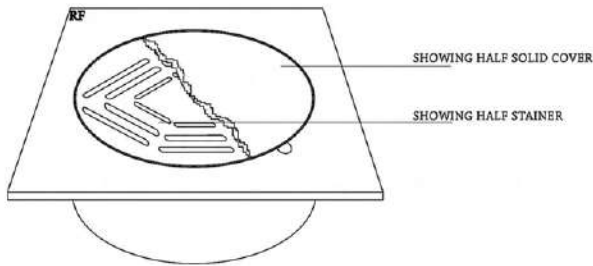

To Suit 110 PVC Pipe

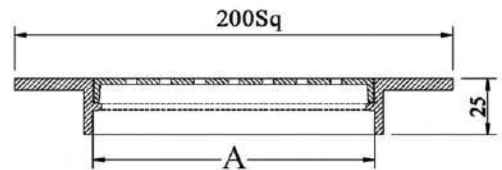

To Suit 110 PVC Pipe

Product Code	Outlet Size (A) (ID)	Overall Size
RF - FDC - 701 / 10	100Ø	150Sq
RF - FDC - 702 / 11	110Ø	150Sq
RF - FDC - 703 / 11	110Ø	200Sq

Floor Drain Clean Out

**Material - Brass
Chrome Polished**

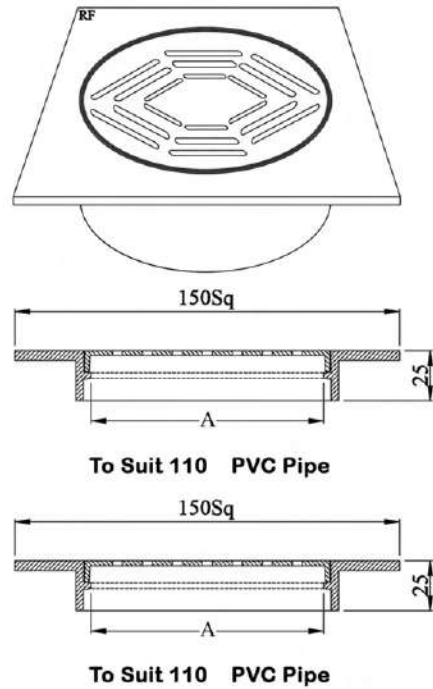

Product Code	Outlet Size (A) (ID)	Overall Size
RF - FD - 801 / 11	110Ø	150Sq
RF - FD - 802 / 11	110Ø	200Sq

SCUPPER DRAIN

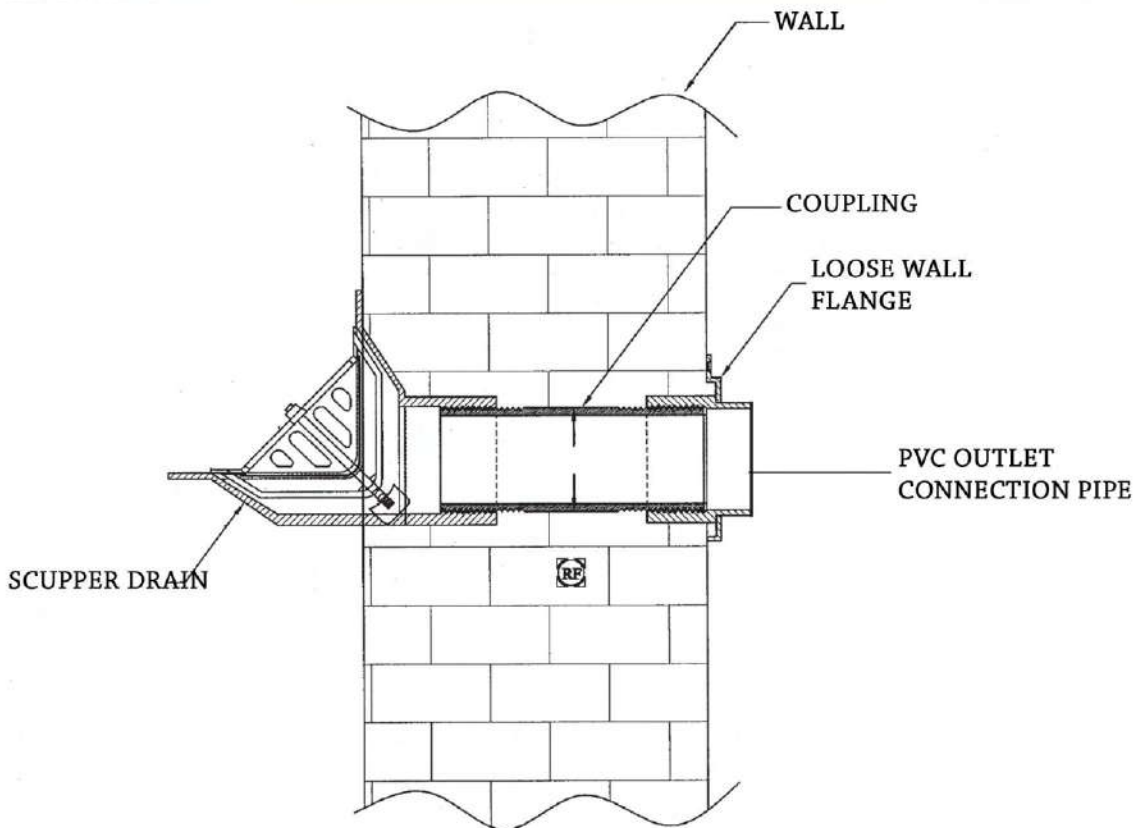

PARAPET SLOPING TYPE GRATE

Grey Cast Iron Body with Aluminium Grates and Flashing Collars

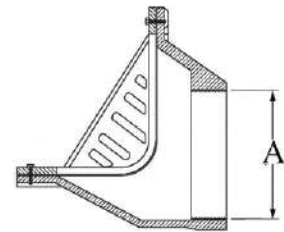
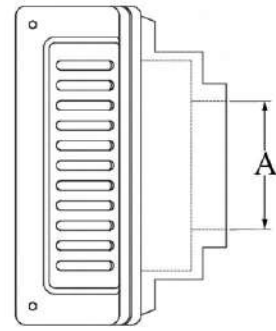

Product Code	Outlet (ID) A (mm)
RF - SD - 501	3" Ø (75mm)
RF - SD - 501 - 50	2" Ø (66mm)
RF - SD - 501 - 75	3" Ø (90mm)
RF - SD - 501 - 100	4" Ø (118mm)

PARAPET SLOPING TYPE GRATE

Grey Cast Iron Body with Aluminium Grates and Flashing Collars

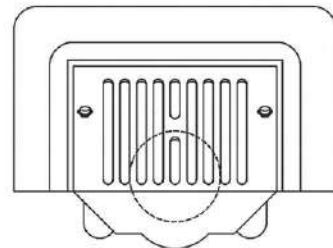
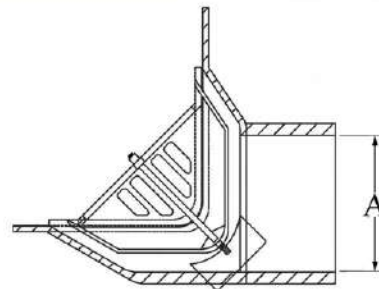

Product Code	Outlet (ID) A (mm)
RF - SD - 506	3" Ø (75mm)
RF - SD - 506 - 50	2" Ø (66mm)
RF - SD - 506 - 75	3" Ø (90mm)
RF - SD - 506 - 100	4" Ø (118mm)

Grey Cast Iron Body with Sloping Grates

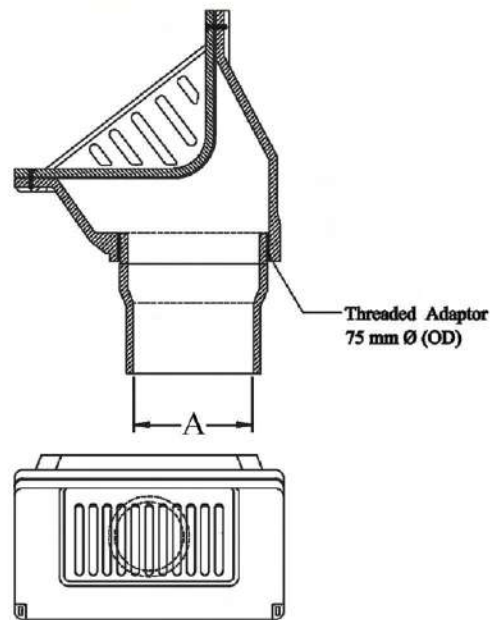

Product Code	Outlet (ID) A (mm)
RF - SD - 507	3" Ø (75mm)
RF - SD - 507 - 50	2" Ø (66mm)
RF - SD - 507 - 75	3" Ø (90mm)
RF - SD - 507 - 100	4" Ø (118mm)

Grey Cast Iron Body with Sloping Grates

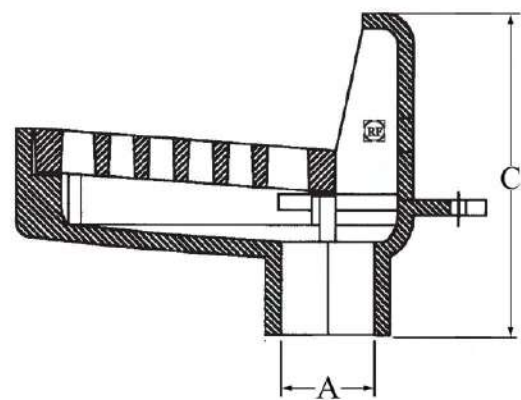
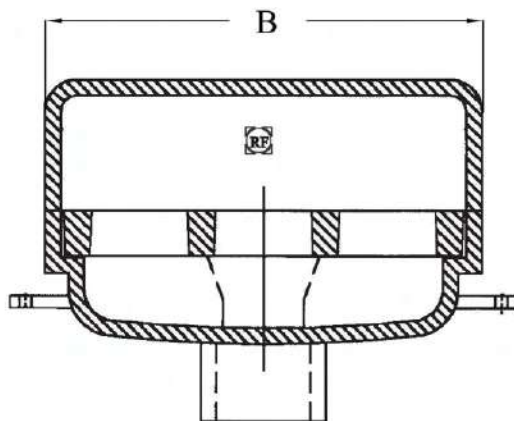

Product Code	Outlet (ID) A mm	Overall Size B mm	Depth C mm
BS - 585 X 648	140Ø	585 X 863	273



VANDAL PROOF HOODED VENT CAP

Cast Iron Body and Hooded Dome Cap Vandal Proof Securing Device

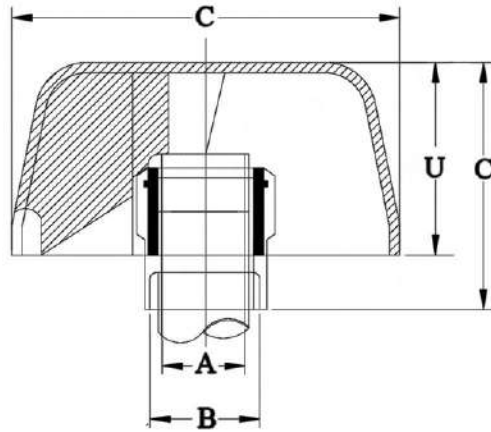

Product Code	Outlet (ID) (A)	B	Doom Cover Box (C)	Height (F)	Cap Height (U)
RF - VC - 401	1 1/2"	2 5/8"	6 1/2"	4 1/8"	2 1/8"
RF - VC - 402	2"	3 1/8"	6 3/8"	4 3/4"	3 1/2"
RF - VC - 403	2 1/2"	3 5/8"	7 1/2"	4 1/8"	2 1/8"
RF - VC - 404	3"	4 1/4"	7 5/8"	5 5/8"	3 1/2"
RF - VC - 405	4"	5 1/4"	9 1/8"	5 5/8"	3 1/2"
RF - VC - 406	5"	6 1/4"	11 1/16"	6 1/4"	4 5/16"
RF - VC - 407	6"	1 1/4"	11 1/16"	6 1/4"	4 5/16"

GUTTER DRAIN

Bottom Outlet

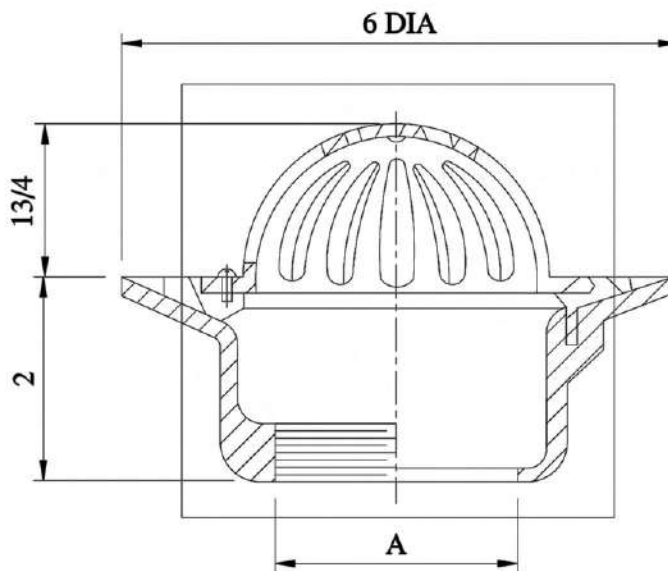

Product Code	Outlet Size (A)
RF - GD - 301	2", 3" and 4"

GUTTER DRAIN

Gutter Drain 45 Degree Outlet

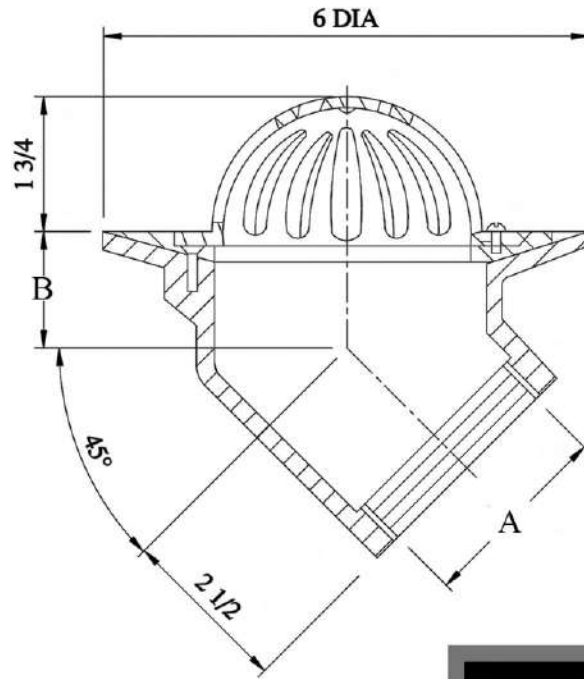

Product Code	Outlet Size (A)
RF - GD - 302	2", 3" and 4

GUTTER DRAIN

Gutter Drain Side Outlet

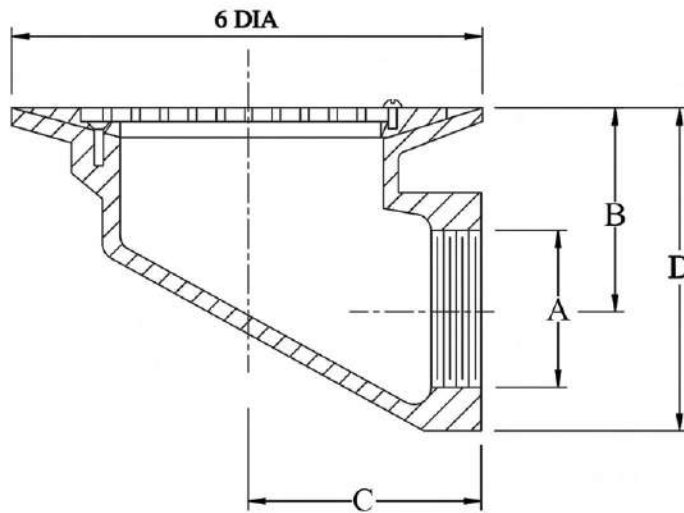

Product Code	Outlet Size (A)
RF - GD - 303	2", 3" and 4



GUTTER DRAIN

Features:-

- Removable Grate
- Galvanized Screws (8mm Dia - 4 Nos)

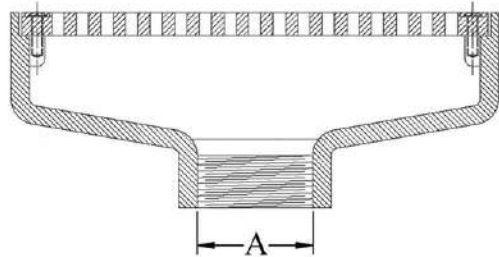
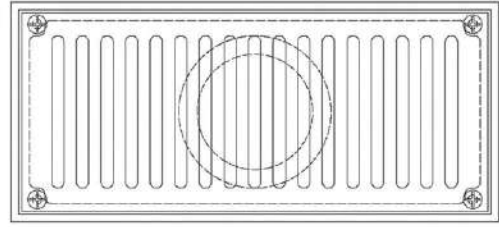

Product Code	Pipe Size A (Inches)	Over Base	Depth	Loading (Tons)	Specifications
RF - GD - 525 - 2"	2	317 X 143	127	40	BS - EN
RF - GD - 525 - 3"	3	317 X 143	127	40	BS - EN
RF - GD - 525 - 4"	4	317 X 143	127	40	BS - EN

CLEAN OUT

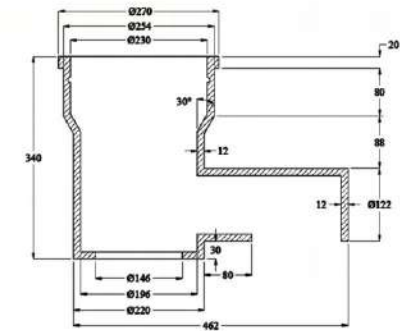

SECTION A-A

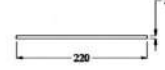

RUBBER GASKET



COVER

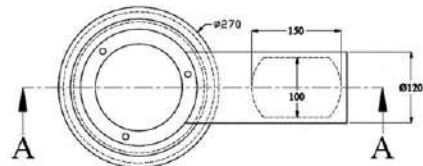

Product Code
RF - CO - 402

Finished Wall Cleanout

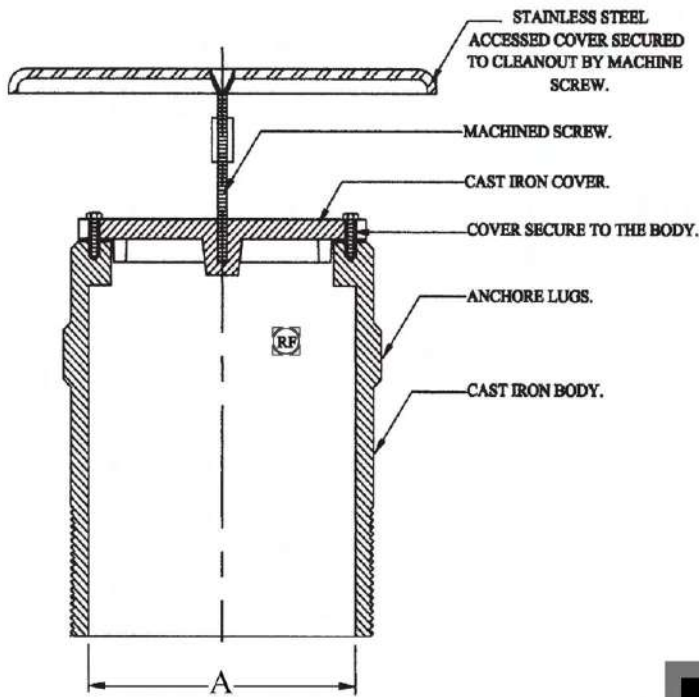

Specifications:-

- Cast Iron Body Adaptable to Pipe
- Stainless Steel Cover Secured to Cleanout By Machine Screw
- Cast Iron Cover Secured to the Body
- Body Provided with anchor Lugs

Product Code	Outlet Size (A)
RF - WCO - 1301	2", 3" and 6"

CLEAN OUT

Specifications:-

- Cast Iron Extended Clean Out with Threaded Brass Finished Head Cleanout Plug

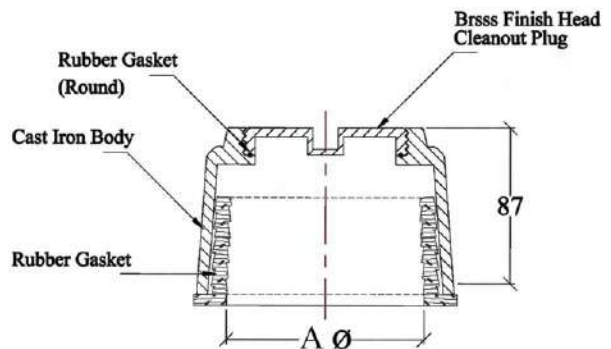
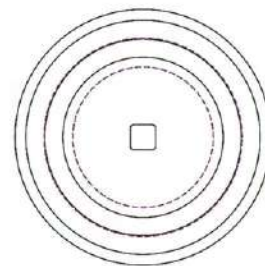

Product Code	Outlet Size (A)
RF - CO - 1020	2", 3" and 6"

Brass Clean Out Body with Brass Strainer

Options:-

- Grey Cast Iron Body

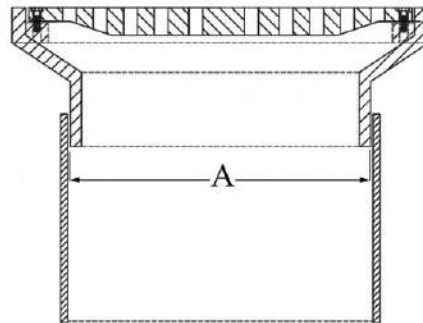
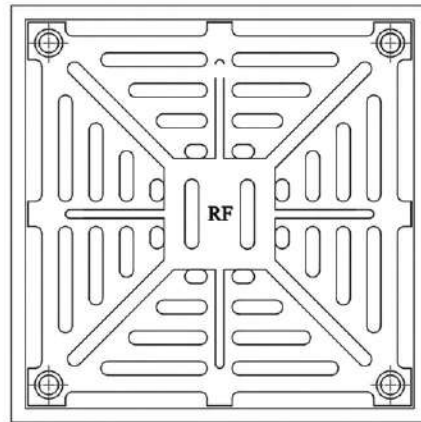

Product Code	Outlet (ID) (A)mm
RF - CO - 150 - 50	50Ø
RF - CO - 150 - 75	75Ø
RF - CO - 150 - 100	100Ø

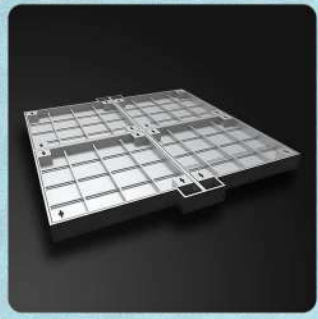
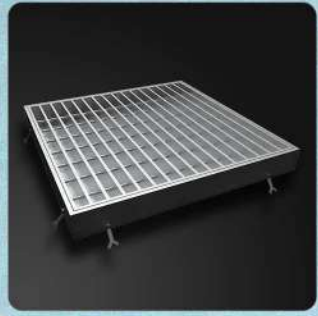

**STEEL FABRICATED PRODUCTS
LADERS, STEP ETC.**

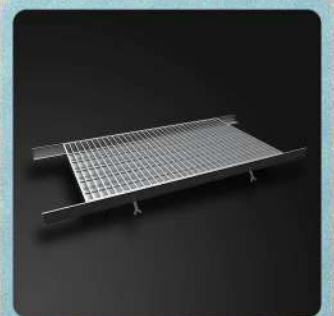
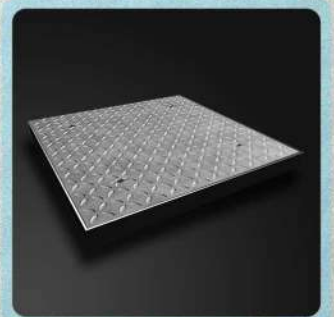
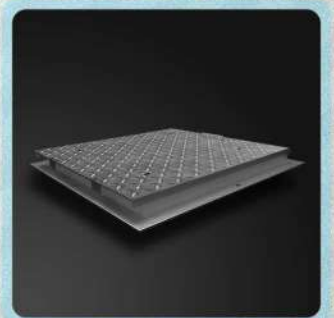

ACCESS LADDER

Access Ladders are Made from Mild Steel Flat bar or Pipe stringers with round deformed / plain bar rungs. Ladders are available with hooks and provided with safety - cage. Sizes are fabricated to suit customer requirement.

Finish:-

Hot dipped galvanized or black painted

GALVANIZED STEEL HOOK LADDER

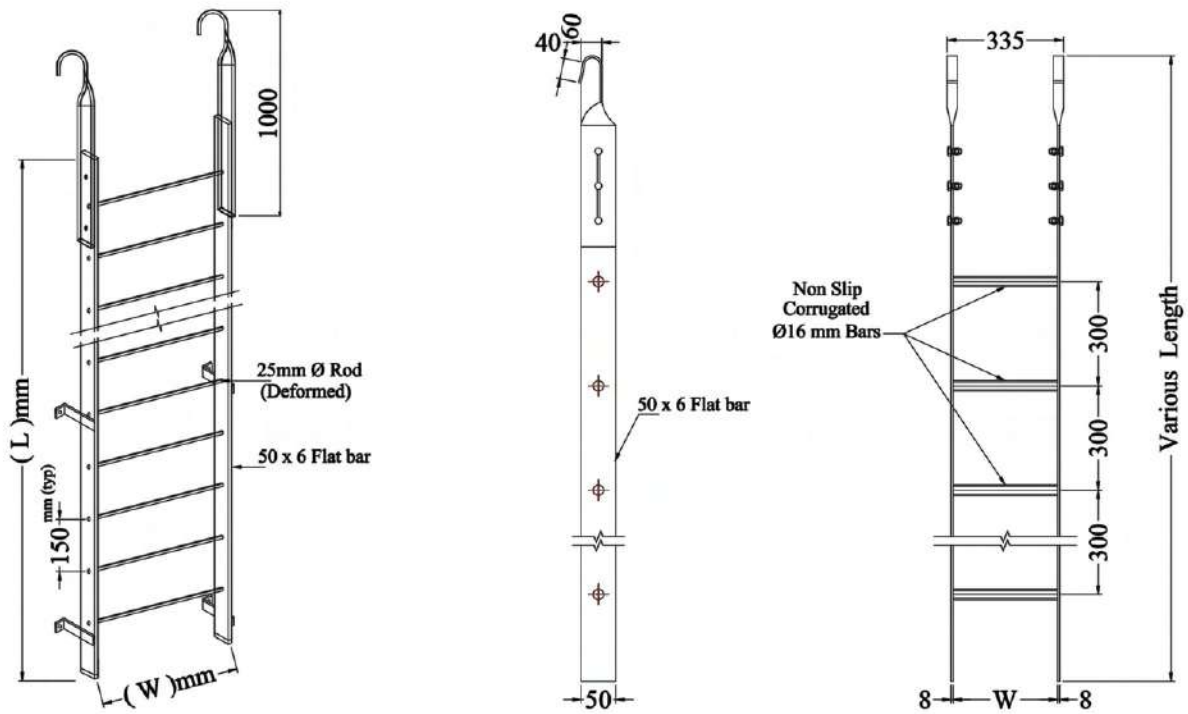

HOOK LADDER

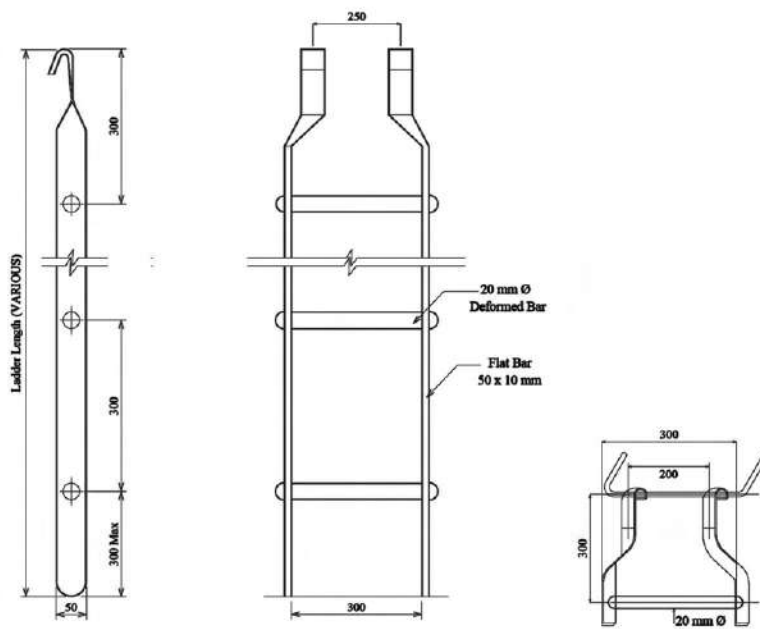

LADDER BRACKET

- Hot Dip Galvanized
- Mild Steel Bracket Type Ladder
- Flat Bar - 50 X 8mm
- 20mmØ Rod.(Deformed)

BRACKET TYPE

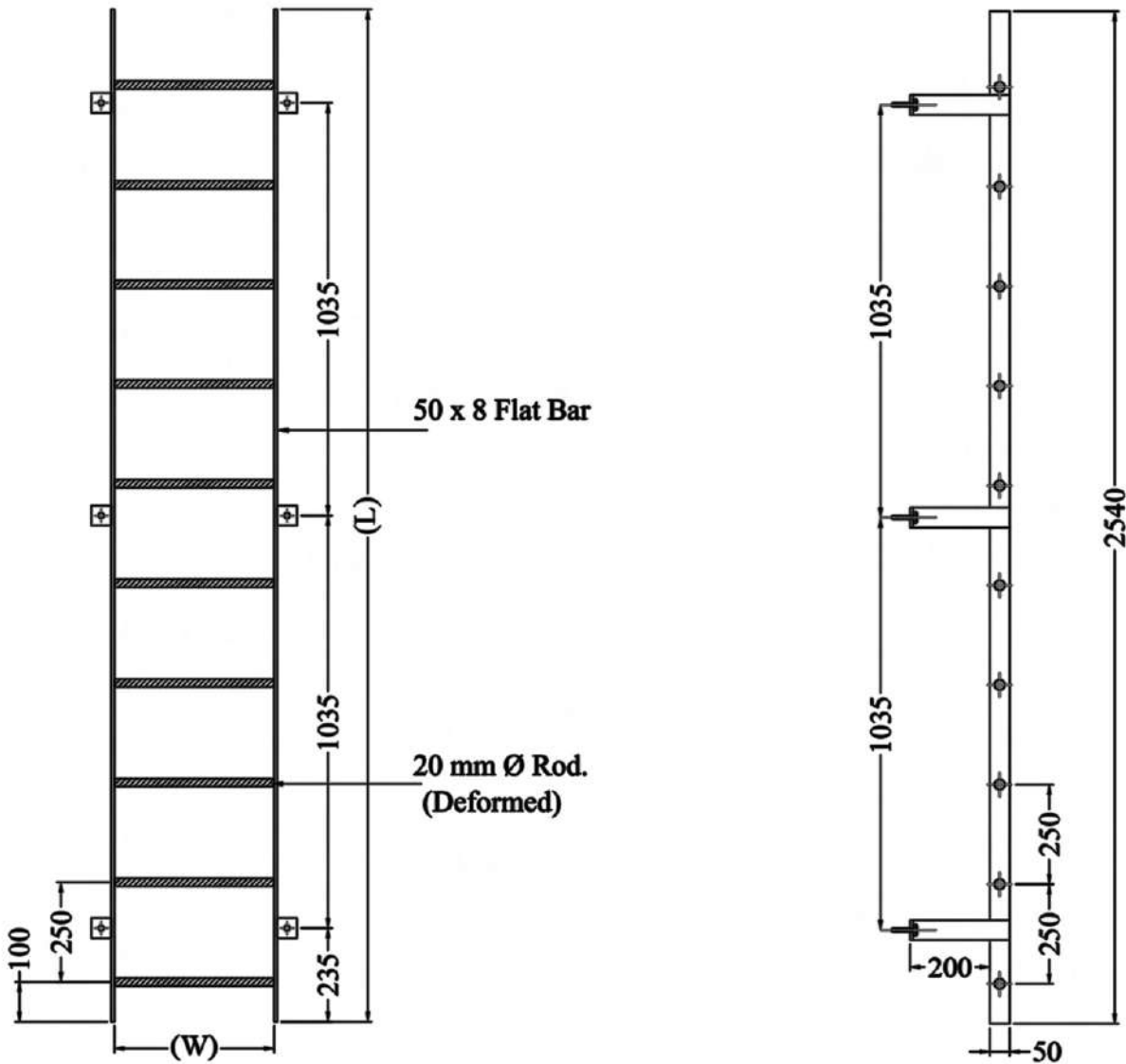

14mmØ Hole
for 12mmØ expansion bolt.

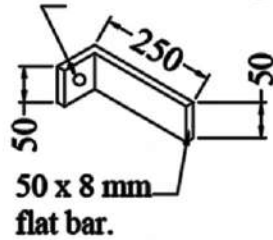

LADDER BRACKET

- Hot Dip Galvanized
- Mild Steel Bracket Type Ladder
- Flat Bar - 50 X 8mm
- 20mm \varnothing Rod.(Deformed)

BRACKET TYPE WITH CAGE

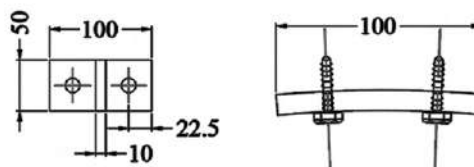
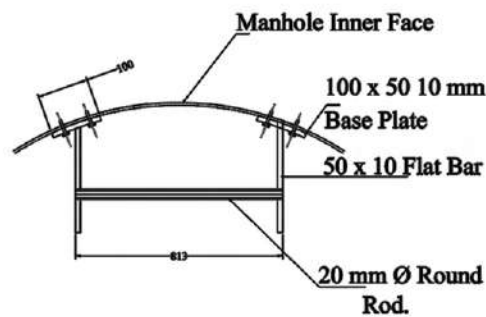
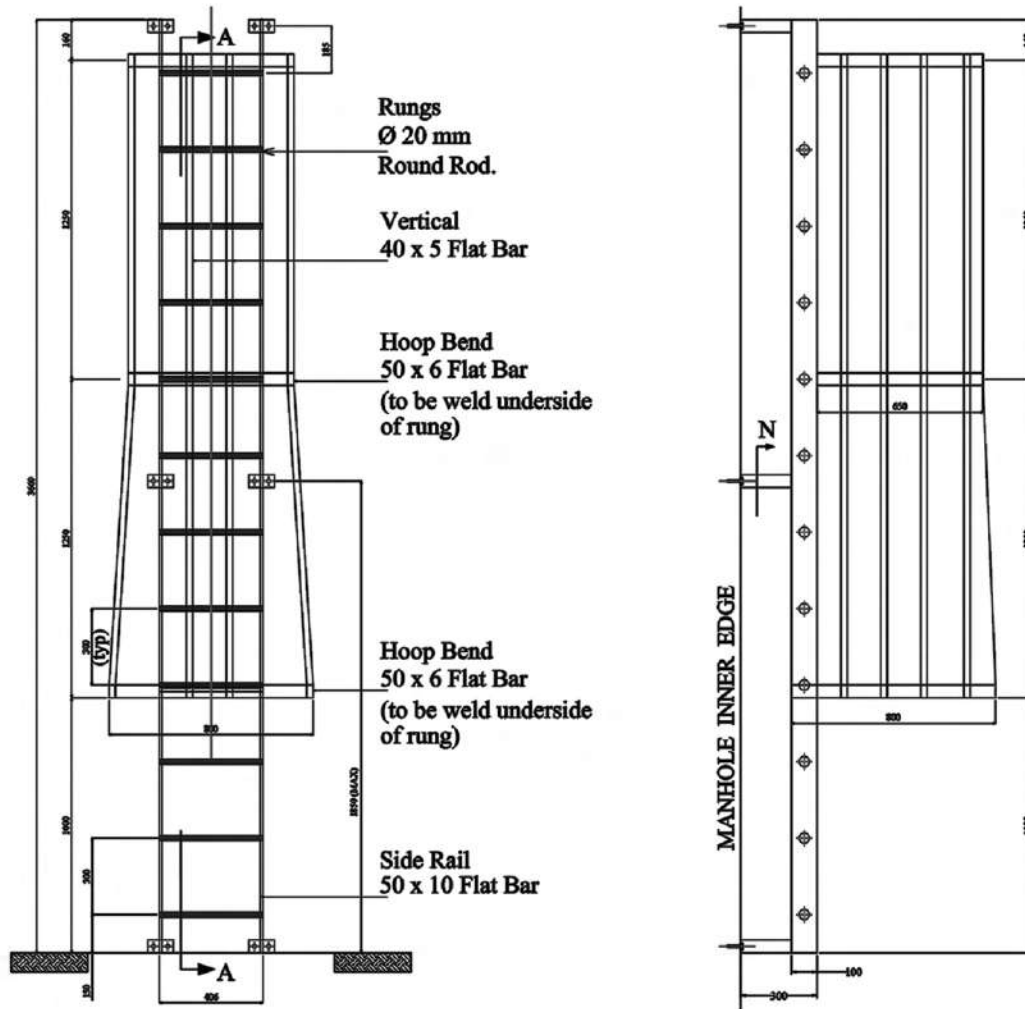

Mild Steel Bar Manhole Step

25mm / 20mm Dia deformed mild steel bar manhole step. Hot dipped galvanized / Black Epoxy coating

We can fabricate any size to meet with customer requirement

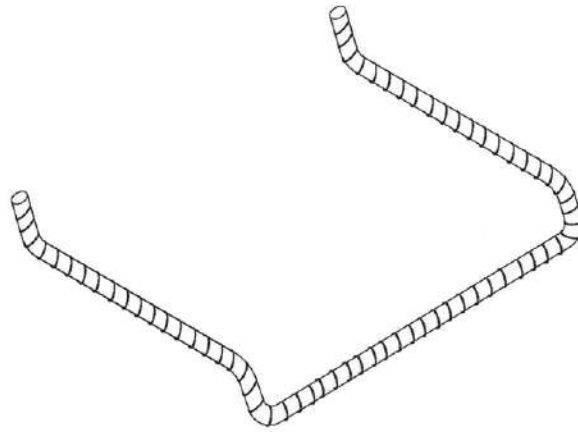

Product Code	Size (mm)
RF - 020 RF - 020 A	300 X 300 200 X 200

Aluminium - Magnesium Silicide Manhole Step

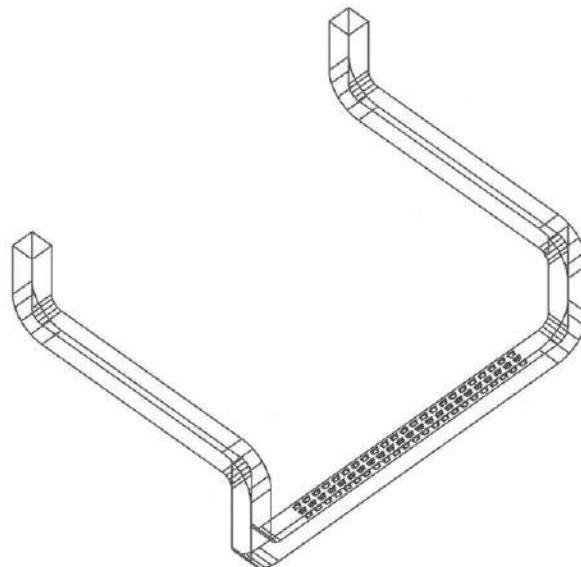

Product Code	Size (mm)
RF - 021	240 X 150

Polyethylene Coated Manhole Step

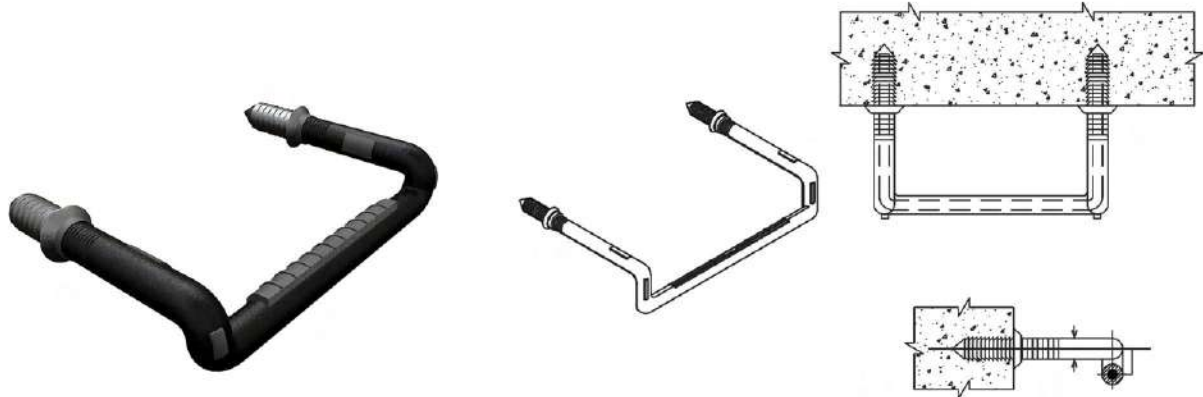

Product Code	Size and Specification (mm)
RF - 022	Mild Steel Material coated with polyethylene - Color black Size : 330 X 220 X 25mm dia.

Polyethylene Coated Manhole Step

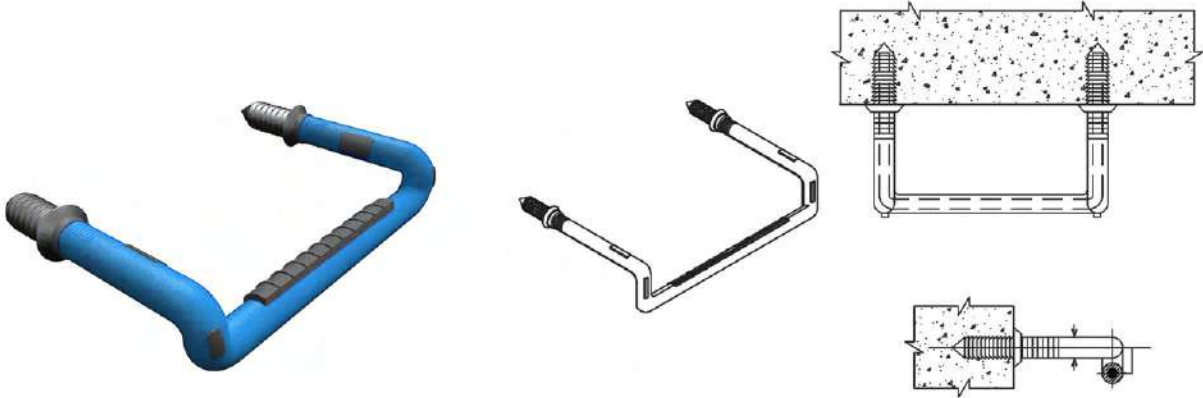

Product Code	Size and Specification (mm)
RF - 023	Aluminium Material coated with polyethylene - Color blue Size : 330 X 220 X 25mm dia.



Polyethylene Coated Manhole Step

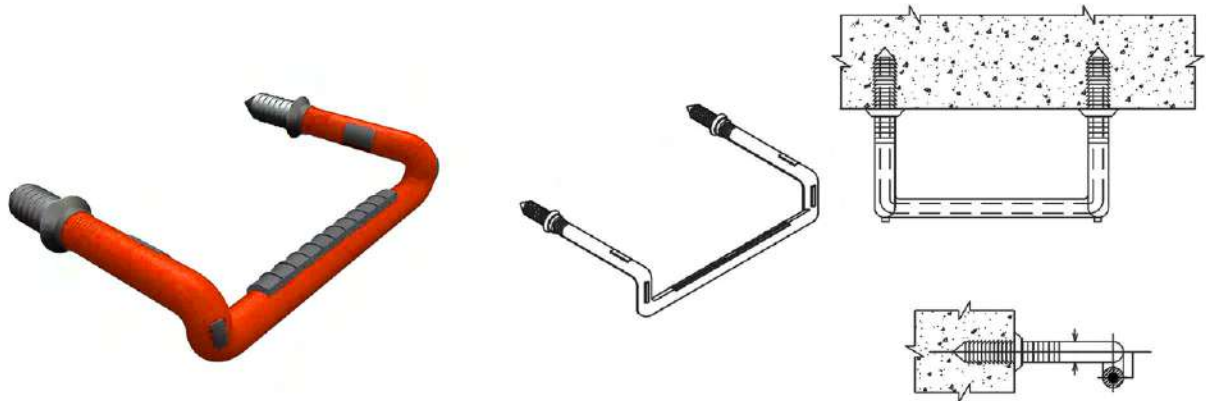

Product Code	Size and Specification (mm)
RF - 024	Stainless Steel Material coated with polyethylene - Color red Size : 330 X 220 X 25mm dia.

Cast Iron Manhole Step

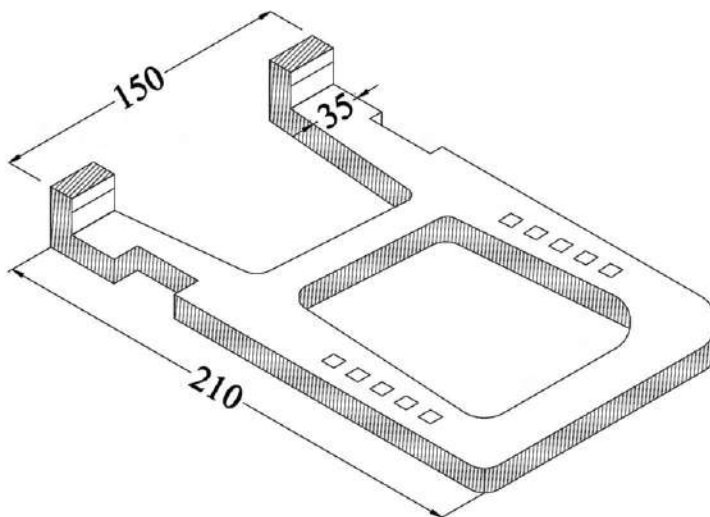

Product Code	Size (mm)
RF - 025 RF - 25 A	210 X 150 250 X 150

Cast Iron / Ductile Iron Manhole Step

Finish:- Black bitumen / black Epoxy coated

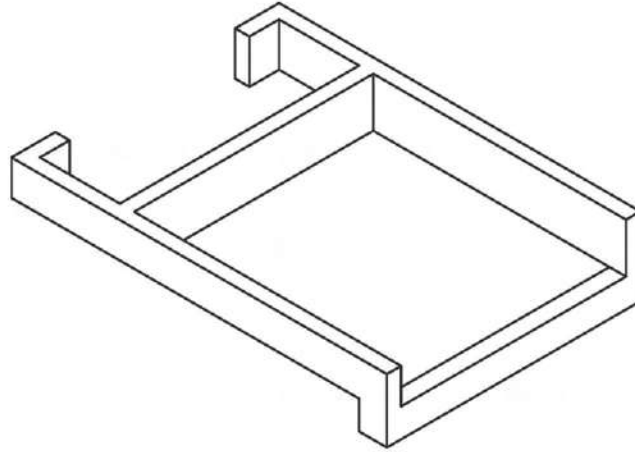

Product Code	Size (mm)
RF - 026	300 X 300

Ductile Iron Manhole Step

Finish:- Hot - dipped galvanized / black Epoxy coated

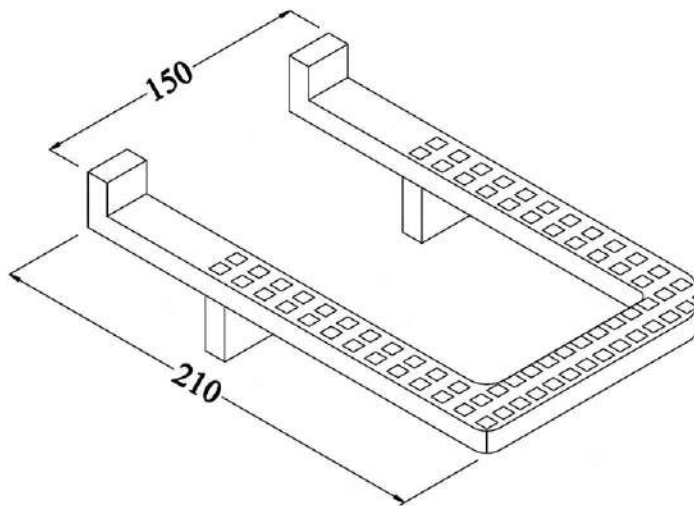

Product Code	Size (mm)
RF - 027	210 X 150
RF - 027	280 X 315



Polyethylene Coated Mild Steel

- Hand Bar of size 225 X 225 X 25mm (RF-HB-002)

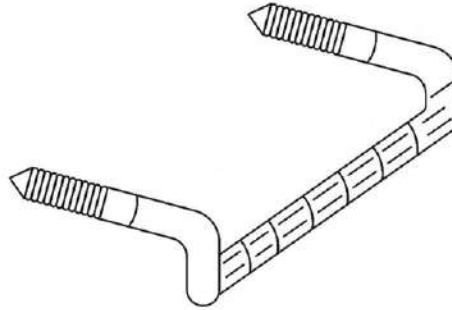

Aluminium Step Coated with Polyethylene (Orange Colour)

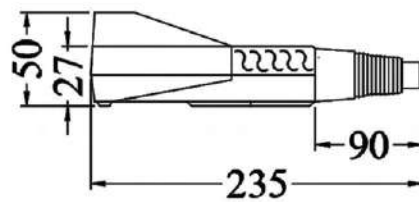
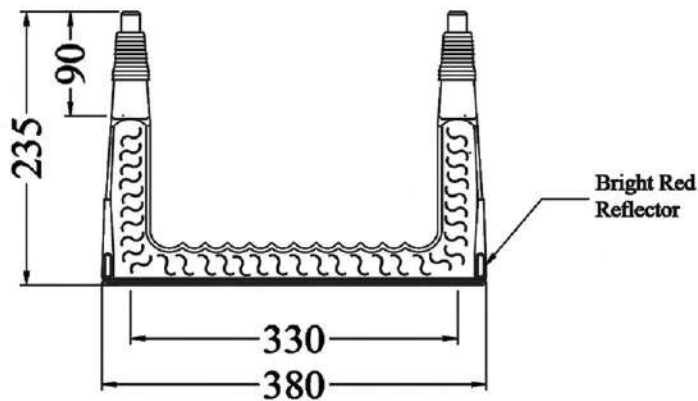

Aluminium Rung Coated With Polyethylene

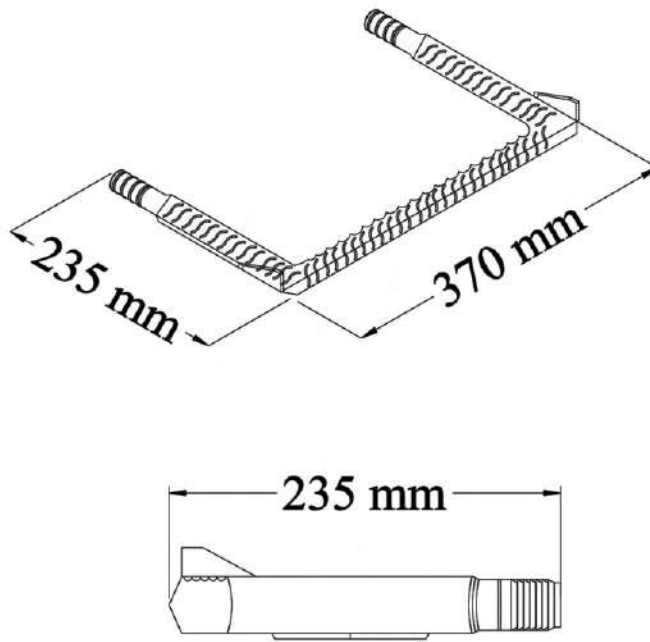

ALUMINUM MANHOLE STEP

Size : 350 X 230

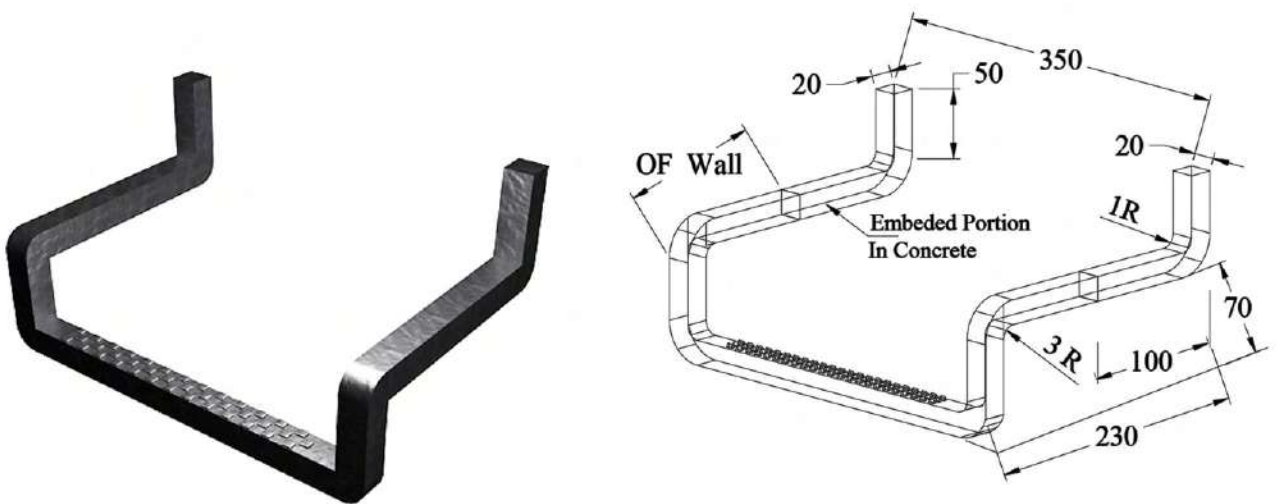

Product Code	Size (mm)
RF - ST - 034	350 X 230

Trench Covers and Frames

Features:-

- Steel Trench Covers and Frames
- Nonslip Covers
- Lifting Key Holes
- Plain Seated

Finish:-

- Hot Dipped Galvanized or Black Painted
- We can fabricate any size to meet with customer requirement

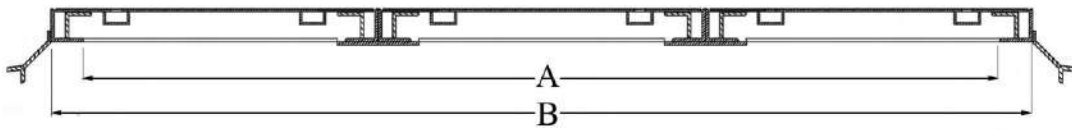
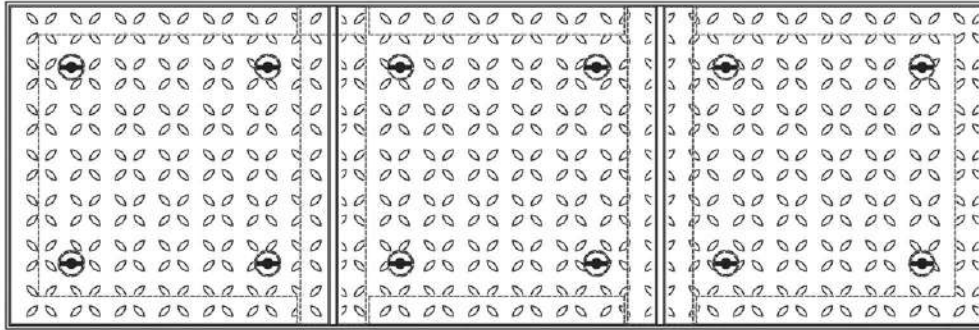

- Loading : Slow Moving Traffic Only

Product Code	Clear Opening (Width) (A)	Light Duty		Medium Duty		Heavy Duty	
		Over Base	Depth	Over Base	Depth	Over Base	Depth
RF - CK - F - 250	250	350	50	410	80	450	100
RF - CK - F - 300	300	400	50	460	80	500	100
RF - CK - F - 400	400	500	50	560	80	600	100
RF - CK - F - 500	500	600	50	660	80	700	100
RF - CK - F - 600	600	700	50	760	80	800	100
RF - CK - F - 750	750	850	50	910	80	950	100
RF - CK - F - 1000	1000	1100	50	1160	80	1200	100

Solid Top Mild Steel Covers and Frames

Single Access Cover and Frames

- Single Leaf Solid Top Manhole Covers and Frames Fabricated From Mild Steel Checkered Plate and Angle Frame
- Cover Non Slip Surface and Provided with Lifting Key Holes

Features:-

- Single or Double Seal / Plain Seated
- Finish : Hot Dipped Galvanized or Black Painted
- Loading : Light, Medium and Slow Moving Heavy Duty

We can fabricate any sizes to meet with customer requirements

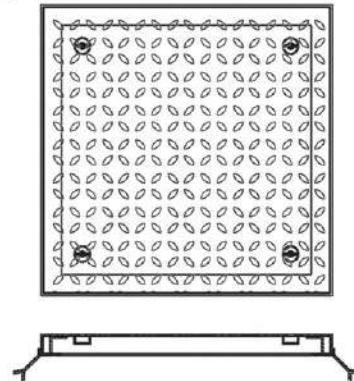

Product Code	Clear Opening	Light Duty		Medium Duty		Heavy Duty	
		Over Base	Depth	Over Base	Depth	Over Base	Depth
RF - ST - 30 X 30	300 X 300	400 X 400	50	460 X 460	80	500 X 500	100
RF - ST - 40 X 40	400 X 400	500 X 500	50	560 X 560	80	600 X 600	100
RF - ST - 50 X 50	500 X 500	600 X 600	50	660 X 660	80	700 X 700	100
RF - ST - 60 X 45	600 X 450	700 X 550	50	760 X 610	80	800 X 650	100
RF - ST - 60 X 60	600 X 600	700 X 700	50	760 X 760	80	800 X 800	100
RF - ST - 90 X 60	900 X 600	1000 X 700	50	1060 X 760	80	1100 X 800	100
RF - ST - 90 X 90	900 X 900	1000 X 1000	50	1060 X 1060	80	1100 X 1100	100

Roof Hatches

Features:-

- Solid Top covers and frames
- Upward opening ceiling access cover and frame are available in single swing or double sizes are fabricated to suit customer requirement

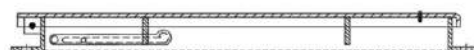
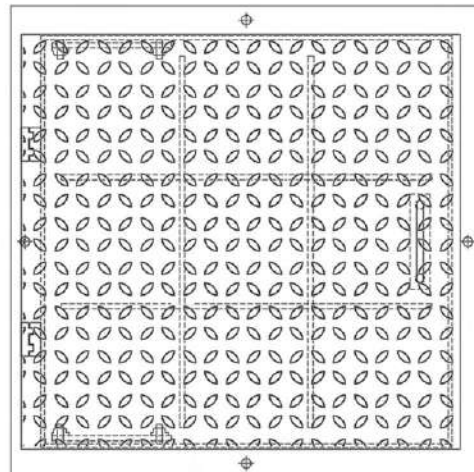

Product Code	Clear Opening	Light Duty		Medium Duty		Heavy Duty	
		Over Base	Depth	Over Base	Depth	Over Base	Depth
RF - HC - 50 X 50	500 X 500	620 X 620	66	660 X 660	86	700 X 700	110
RF - HC - 60 X 60	600 X 600	720 X 720	66	760 X 760	86	800 X 800	110
RF - HC - 70 X 70	700 X 700	820 X 820	66	860 X 860	86	900 X 900	110
RF - HC - 120 X 120	1200 X 1200	1340 X 1340	66	1360 X 1360	86	1400 X 1400	110



Hinged Access Covers and Frames

Features:-

- Solid Top covers and frames
- With Safety Stay, cover locked to frame by spring latch.
- 2 Nos. Closed Key Holes

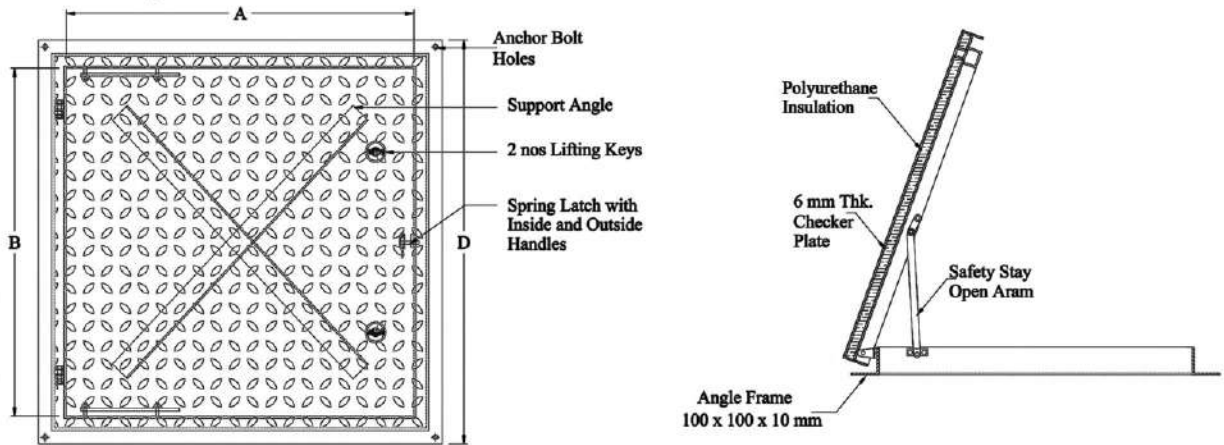

Product Code	Clear Opening A (mm)	Over Base B (mm)	Depth C (mm)
MC - 60 X 60 C2 SL	600 X 600	740 X 740	100
MC - 100 X 100 C2 SL	1000 X 1000	1140 X 1140	100
MC - 120 X 60 C2 SL	1200 X 600	1340 X 1340	100

Solid Top Safety Stay Cover and Frames

Features:-

- Solid Top Twin Leaf, hinged covers with frames
- Application in water authority and pumping stations, reservoirs and sewage works. Where Unrestricted access facilities are important
- Sizes are fabricated to suit customer requirement.

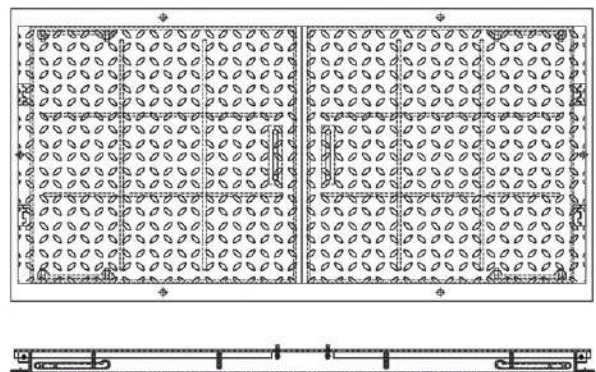

Product Code	Clear Opening A X B (mm)	Over Base C X D (mm)	Depth E (mm)
RF - HC 100 X 50	1000 X 500	1140 X 640	78
RF - HC 100 X 60	1000 X 600	1340 X 740	78
RF - HC 100 X 75	1000 X 750	1140 X 890	78
RF - HC 120 X 60	1200 X 600	1340 X 740	78
RF - HC 120 X 100	1200 X 1000	1340 X 1140	78

Recessed Top Single Trench Type and Multiple Mild Steel Covers and Frames

Light Medium Duty:-

- Steel recessed SQUARE and RECTANGULAR type access covers and frames. Cover recessed for concrete / Tiles infill. Infilling depth 43mm or AS PER YOUR REQUIREMENT
- Cover provided with 2 Nos of Lifting Key Holes

Application:-

- For internal and external use special where the finished appearance of the Manhole Cover is of Prime Importance.

Options:-

- Cover Bolted to the frame, Single seal or Double seal, Top edges of the cover and frame finished in BRASS or STAINLESS STEEL

Steel Finish:-

- Hot dipped galvanized or black painted

Recessed type cover and frame can be fabricated twin, Triple, Multiple, and Trench type according to customer requirement.

Single



Double



Triple



Multiple



We can fabricate any size to meet with customer requirement

Product Code	Clear Opening (mm)	Light Duty		Medium Duty	
		Over Base	Depth	Over Base	Depth
RF - SRC - 20 X 20	200 X 200	360 X 360	80	400 X 400	100
RF - SRC - 30 X 30	300 X 300	460 X 460	80	500 X 500	100
RF - SRC - 40 X 40	400 X 400	560 X 560	80	600 X 600	100
RF - SRC - 50 X 50	500 X 500	660 X 660	80	700 X 700	100
RF - SRC - 60 X 45	600 X 450	760 X 610	80	800 X 650	100
RF - SRC - 60 X 60	600 X 600	760 X 760	80	800 X 800	100
RF - SRC - 70 X 70	700 X 700	860 X 860	80	900 X 900	100
RF - SRC - 80 X 80	800 X 800	960 X 960	80	1000 X 1000	100
RF - SRC - 90 X 60	900 X 600	1060 X 760	80	1100 X 800	100
RF - SRC - 90 X 90	900 X 900	1060 X 1060	80	1100 X 1100	100
RF - SRC - 100 X 100	1000 X 1000	1160 X 1160	80	1200 X 1200	100



Multiple Solid Top Mild Steel Cover and Frames

Features:-

- Twin, Tripple and Multiple Solid Top Covers and Frames
- Removable Beams and “T” Bars will be Provided for Multiple access Covers and Frames for safety loading
- Steel Trench Covers and Frames
- Non Slip Covers
- Lifting Handles

Loading:-

- Slow Moving Traffic Only

Options:-

- Non slip covers
- Lifting Key Holes

Finish:-

- Hot Dipped Galvanized or Black Painted

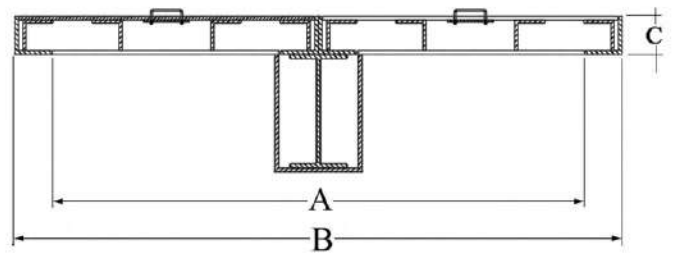
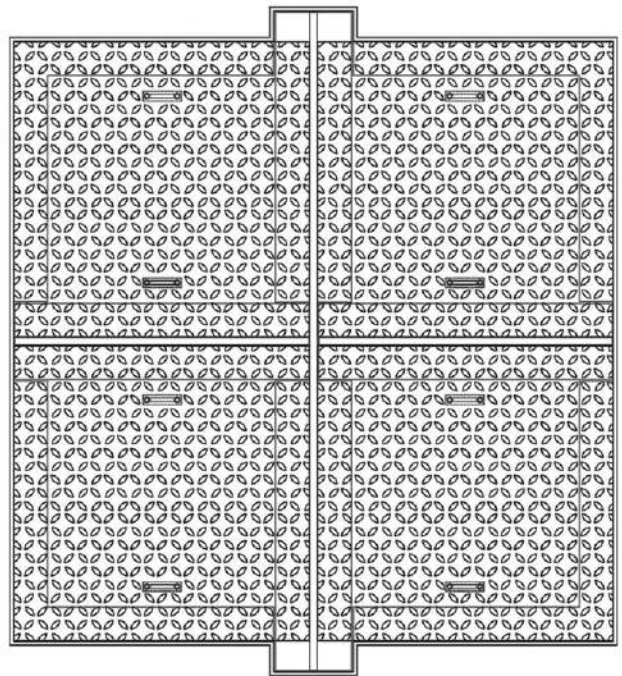

Product Code	Clear Opening (mm)	Medium Duty		Heavy Duty	
		Over Base	Depth	Over Base	Depth
RF - AC - 1000	1000 X 1000	1200 X 1200	100	1200 X 1100	100
RF - AC - 1500	1500 X 1500	1700 X 1700	100	1700 X 1700	100
RF - AC - 2000	2000 X 2000	2200 X 2200	100	2200 X 2200	100

Mild Steel Trench Grates and Frames

Loading:-

- Light, Medium and slow moving traffic Heavy Duty

Finish:-

- Hot Dipped Galvanized or black painted

We can fabricate any size to meet with customer requirement

Multiple

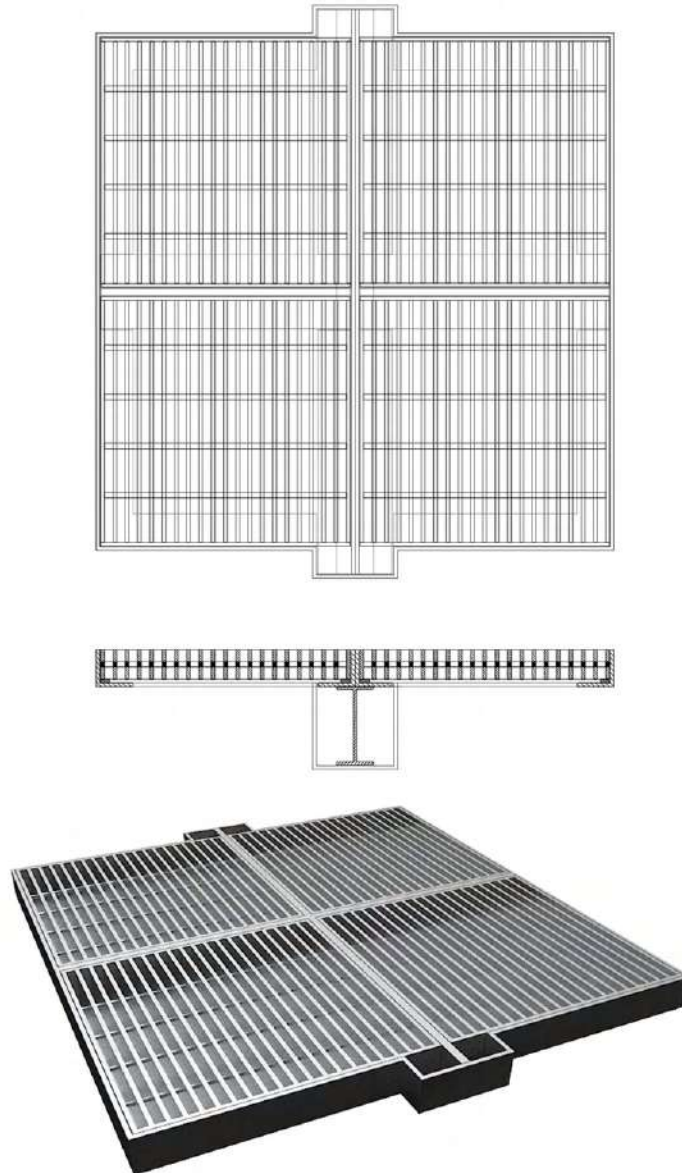

Product Code	Clear Opening (Width) (A)	Light Duty		Medium Duty		Heavy Duty	
		Over Base	Depth	Over Base	Depth	Over Base	Depth
RF - MSG - F 30 X 30	300 X 300	400 X 400	50	460 X 460	80	500 X 500	100
RF - MSG - F 40 X 40	400 X 400	500 X 500	50	560 X 560	80	600 X 600	100
RF - MSG - F 50 X 50	500 X 500	600 X 600	50	660 X 660	80	700 X 700	100
RF - MSG - F 60 X 45	600 X 450	700 X 550	50	760 X 610	80	800 X 650	100
RF - MSG - F 60 X 60	600 X 600	700 X 700	50	760 X 760	80	800 X 800	100
RF - MSG - F 75 X 60	750 X 600	850 X 700	50	910 X 760	80	950 X 800	100
RF - MSG - F 75 X 75	750 X 750	850 X 850	50	910 X 910	80	950 X 950	100
RF - MSG - F 80 X 80	800 X 800	900 X 900	50	960 X 960	80	1000 X 1000	100
RF - MSG - F 90 X 60	900 X 600	1000 X 700	50	1060 X 760	80	1100 X 800	100
RF - MSG - F 90 X 90	900 X 900	1000 X 1000	50	1060 X 1060	80	1100 X 1100	100
RF - MSG - F 100 X 100	1000 X 1000	1100 X 1100	50	1160 X 1160	80	1200 X 1200	100



Mild Steel Trench Grates and Frames

Loading:-

- Light, Medium and slow moving traffic Heavy Duty

Finish:-

- Hot Dipped Galvanized or black painted

We can fabricate any size to meet with customer requirement

Square For 3D Purpose

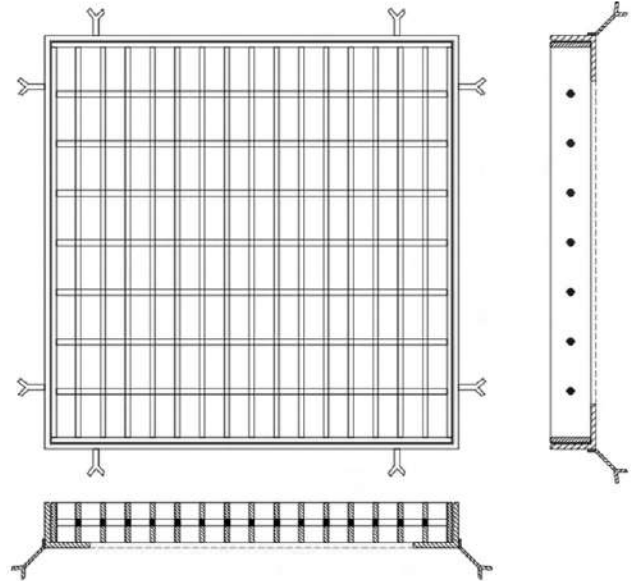

Mild Steel Trench Grates and Frames

Loading:-

- Light, Medium and slow moving traffic Heavy Duty

Finish:-

- Hot Dipped Galvanized or black painted

We can fabricate any size to meet with customer requirement

Rectangle For 3D Purpose

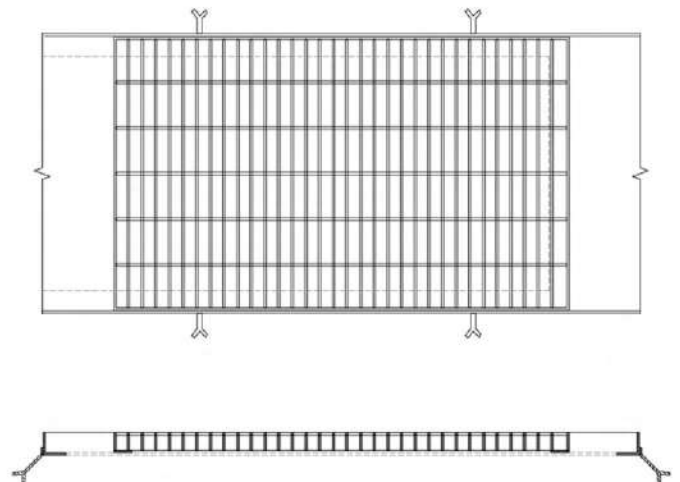

CIRCULAR COVERS AND FRAMES

<u>CLEAR OPENING</u>	<u>CATALOGUE NO</u>	<u>PAGE NO</u>
450 dia	MC-045(LD)	27
450 dia	MC-045(MD)	27
450 dia	MC-045(HD)	27
500 dia	MC-050(LD)	27
500 dia	MC-050(MD)	27
500 dia	MC-050(HD)	27
500 dia	MC-050EDI(HD)	27
550 dia	MC-120AR1(HD)	28
600 dia	MC-051A(HD)	28
600 dia	MC-051AE(HD)	28
600 dia	MC-051AF(HD)	28
600 dia	MC-100(LD)	29
600 dia	MC-100RM1(MD)	29
600 dia	MC-101(MD)	29
600 dia	MC-101DSAR3(HD)	29
600 dia	MC-101R1(MD)	29
600 dia	MC-101R2M(HD)	29
600 dia	MC-100RDIM(MD)	29
600 dia	MC-100RDIM(HD)	29
600 dia	MC-100RM1DI(HD)	29
600 dia	MC-101ADI(MD)	30
600 dia	MC-101ADI(HD)	30
600 dia	MC-105(HD)	30
600 dia	MC-105(MD)	30
600 dia	MC-105DIE(HD)	31
600 dia	MC-105DIF(HD)	31
600 dia	MC-106DI(MD)	31
600 dia	MC-106DI(HD)	31
600 dia	MC-106DIAR1(HD)	32
600 dia	MC-106DIAR2(HD)	32
600 dia	MC-106DIAR1N(HD)	32
600 dia	MC-106DIAR2N(HD)	32
600 dia	MC-106DIAR3N(HD)	32
600 dia	MC-106AR3H(HD)	33
600 dia	MC-109-120 DIH(HD)	33
600 dia	MC-109-R4DIH(HD)	33
600 dia	MC-109R4H(HD)	34
600 dia	MC-109DI(MD)	34
600 dia	MC-109DI(HD)	34
600 dia	MC-110(MD)	35
600 dia	MC-110(HD)	35
600 dia	MC-110R1HD(HD)	35
600 dia	MC-115DI(HD)	36
600 dia	MC-115(MD)	36
600 dia	MC115(HD)	36
600 dia	MC-115R1SG(HD)	37

CIRCULAR COVERS AND FRAMES

<u>CLEAR OPENING</u>	<u>CATALOGUE NO</u>	<u>PAGE NO</u>
600 dia	MC-115R2SG(HD)	37
600 dia	MC-115A4(HD)	37
600 dia	MC-116R2DI(HD)	38
610 dia	MC-116(HD)	38
622 dia	MC-125(HD)	39
625 dia	MC-112R(HD)	39
680 dia	MC-120A(HD)	40
680 dia	MC-120(HD)	40
680 dia	MC-120C(HD)	40
680 dia	MC-120AL(HD)	40
690 dia	MC-120 A4(HD)	41
700 dia	MC-051AR1DI(MD)	41
700 dia	MC-051ARIDI(HD)	41
700 dia	MC-051AER1DI(HD)	41
750 dia	MC-112(LD)	42
750 dia	MC-112(MD)	42
750 dia	MC-112(HD)	42
750 dia	MC-120AR6(HD)	42
760 dia	MC-113R4(LD)	43
760 dia	MC-113R4(MD)	43
760 dia	MC-113R4(HD)	43
760 dia	MC-121(MD)	43
760 dia	MC-121(HD)	43
800 dia	MC-107DSDI(HD)	44
800 dia	MC-123(LD)	44
800 dia	MC-123(MD)	44
800 dia	MC-123(HD)	44
900 dia	MC-126DIE(HD)	45
900 dia	MC-126RDIF(HD)	45
1100 dia	MC-127DIR2(MD)	45
1100 dia	MC-127DIR2(HD)	45

CIRCULAR COVERS AND SQUARE FRAMES

<u>CLEAR OPENING</u>	<u>CATALOGUE NO</u>	<u>PAGE NO</u>
400 dia	MC-171R5DI(HD)	49
415 dia	MC-171DI(MD)	49
415 dia	MC-171DI(HD)	49
415 dia	MC-171(LD)	49
500 dia	MC-150(MD)	49
500 dia	MC-150(HD)	49
550 dia	MC-172(LD)	50
550 dia	MC-172DI(MD)	50
550 dia	MC-172DI(HD)	50
600 dia	MC-151(MD)	50
600 dia	MC-151(HD)	50

CIRCULAR COVERS AND SQUARE FRAMES

<u>CLEAR OPENING</u>	<u>CATALOGUE NO</u>	<u>PAGE NO</u>
600 dia	MC-151RDI(HD)	51
600 dia	MC-160(HD)	51
600 dia	MC-160R1DI(HD)	52
600 dia	MC-165(HD)	52
600 dia	MC-170DIA1E(HD)	53
600 dia	MC-170DIA2F(HD)	53
600 dia	MC-170ADS(HD)	53
600 dia	MC-170R1DIA2(HD)	54
600 dia	MC-173(LD)	54
600 dia	MC-174(LD)	54
600 dia	MC-175(LD)	54
600 dia	MC-176(LD)	54
600 dia	MC-177(LD)	54
600 dia	MC173DI(HD)	55
600 dia	MC-175DI(MD)	55
600 dia	MC-175DI(HD)	55
600 dia	MC176DI(MD)	55
600 dia	MC-176DI(HD)	55
700 dia	MC-170R6(HD)	55
750 dia	MC-165R2(HD)	56
800 dia	MC-161DI(HD)	56
800 dia	MC-170(MD)	57
800 dia	MC-170(HD)	57
800 dia	MC-170AR3(HD)	57
900 dia	MC-170AR1(HD)	57
900 dia	MC-170DI(HD)	58
915 dia	MC-131(HD)	58
915 dia	MC-131RDI(HD)	59
920 dia	MC-130(HD)	59
560 dia	RF-CG 48 1"	60
600 dia	RF-CG 48 1"	60

SQARE COVERS AND FRAMES

<u>CLEAR OPENING</u>	<u>CATALOGUE NO</u>	<u>PAGE NO</u>
200 sq	MC-200(LD)	63
200 sq	MC-200(MD)	63
200 sq	MC-200(HD)	63
300 sq	MC-201(LD)	63
300 sq	MC-201(MD)	63
300 sq	MC-201(HD)	63
300 sq	MC-201DI(HD)	63
300 sq	MC-203(LD)	64
350 sq	MC-201R2(MD)	64
350 sq	MC-201R2(HD)	64
400 sq	MC-202(LD)	65

SQUARE COVERS AND FRAMES

<u>CLEAR OPENING</u>	<u>CATALOGUE NO</u>	<u>PAGE NO</u>
400 sq	MC-202(MD)	65
400 sq	MC-202(HD)	65
400 sq	MC-203R1(LD)	65
400 sq	MC-204R1DT(HD)	66
450 sq	MC-203AR4(MD)	66
450 sq	MC-203AR4(HD)	66
450 sq	MC-203R2(LD)	67
500 sq	MC-203R3(LD)	67
500 sq	MC-204R2DT(HD)	67
500 sq	MC-205(LD)	68
500 sq	MC-205(MD)	68
500 sq	MC-205(HD)	68
500 sq	MC-205DI(HD)	68
500 sq	MC-205RWT(MD)	68
500 sq	MC-205RWT(HD)	68
500 sq	MC-251DI(HD)	69
600 sq	MC-204R3DT(HD)	69
600 sq	MC-204R4DT/DI(HD)	70
600 sq	MC-210(LD)	70
600 sq	MC-210(MD)	70
600 sq	MC-210(HD)	70
600 sq	MC-210A(LD)	70
600 sq	MC-210R2(HD)	70
600 sq	MC-211(HD)	70
600 sq	MC-211A(HD)	70
600 sq	MC-210RWT(MD)	71
600 sq	MC-210RWT(HD)	71
600 sq	MC-210AR1DI(MD)	71
600 sq	MC-210AR1DI(HD)	71
600 sq	MC-210HR1L(MD)	72
600 sq	MC-210HR1L(HD)	72
600 sq	MC-212R1(HD)	72
600 sq	MC-213DI(HD)	73
600 sq	MC-215(LD)	73
600 sq	MC-215(MD)	73
600 sq	MC-215(HD)	73
600 sq	MC-215RDI(HD)	74
600 sq	MC-225SR2DI(LD)	74
600 sq	MC-225SR2DI(MD)	74
600 sq	MC-225SR2DI(HD)	74
600 sq	MC-240DI(LD)	75
600 sq	MC-240DI(MD)	75
600 sq	MC-240R1DI(MD)	75
650 sq	MC-240R1DI(HD)	75
675 sq	MC-241SSR1DI(HD)	76
675 sq	MC-675X675DT(HD)	76

SQUARE COVERS AND FRAMES

<u>CLEAR OPENING</u>	<u>CATALOGUE NO</u>	<u>PAGE NO</u>
675 sq	MC-675X675DTD(HD)	77
700 sq	MC-250(LD)	77
700 sq	MC-250(MD)	77
700 sq	MC-250(HD)	77
700 sq	MC-250DIDT(HD)	78
700 sq	MC-250DS(HD)	78
750 sq	MC-242(MD)	79
750 sq	MC-251(MD)	79
800 sq	MC-252DI(HD)	79
800 sq	MC-255RWT(MD)	80
800 sq	MC-255RWT(HD)	80
800 sq	MC-255HR1L(MD)	80
800 sq	MC-255HR1L(HD)	80
800 sq	MC-255(LD)	81
800 sq	MC-255(MD)	81
800 sq	MC-255(HD)	81
800 sq	MC-255A(MD)	81
800 sq	MC-255A(HD)	81
900 sq	MC-255DS(HD)	81
900 sq	MC-260(LD)	82
900 sq	MC-260(MD)	82
900 sq	MC-260(HD)	82
900 sq	MC-260DS(MD)	82
900 sq	MC-260DS(HD)	82
1000 sq	MC-270DSN(HD)	82
900 sq	MC-260WTDI(HD)	83
900 sq	MC-265DI(HD)	83
900 sq	MC266R1DI(HD)	83
900 sq	MC-265(MD)	84
900 sq	MC-265(HD)	84
900 sq	MC-266(HD)	84
950 sq	MC-270AR1(HD)	84
1000 sq	MC-270(LD)	85
1000 sq	MC270(MD)	85
1000 sq	MC-270(HD)	85
1000 sq	MC-270AR3C2(HD)	85

RECTANGULAR MULTIPLE COVERS AND FRAMES

<u>CLEAR OPENING</u>	<u>CATALOGUE NO</u>	<u>PAGE NO</u>
360X230	MC-301(HD)	89
460X200	MC-301R5DI(MD)	89
500X700	MC-307(MD)	90
600X400	MC-304R4(HD)	90

RECTANGULAR MULTIPLE COVERS AND FRAMES

<u>CLEAR OPENING</u>	<u>CATALOGUE NO</u>	<u>PAGE NO</u>
600X450	MC-300(MD)	90
600X450	MC-300(HD)	90
625X750	MC-472ARDI(HD)	91
600 sq	MC-315DIMR3/200/40(HD)	91
750X600	MC-305(MD)	92
750X600	MC-305(HD)	92
760X420	MC-304(HD)	92
760X460	MC-305A2DI(LD)	92
760X460	MC-305A2DI(MD)	92
760X460	MC-305A2DI(HD)	92
900X600	MC-310DS(MD)	93
900X600	MC-310DS(HD)	93
900X600	MC-310(MD)	93
900X600	MC-310(HD)	93
900X600	MC-310E(HD)	93
900X600	MC-315(HD)	94
900X450	MC-316HR1(MD)	94
900X700	MC-318R2(HD)	95
900X450	MC-355(HD)	95
900X450	MC-355R1(HD)	95
1000X600	MC-318R4(HD)	96
1000X600	MC-315R(HD)	96
1000X600	MC-354AR2C2(HD)	97
1050X950	MC-351MR5(MD)	97
1100X800	MC-351R3(HD)	98
1100X580	MC-358R2C2(LD)	98
1100X580	MC-358R2C2(MD)	98
1100X580	MC-358R2C2(HD)	98
1200X600	MC-315RM4(HD)	98
1200X600	MC-354DIF(MD)	99
1200X600	MC-354DIF(HD)	99
1200X600	MC-354(HD)	99
1200X600	MC-354AR3C2(HD)	100
1200X600	MC-353DT(HD)	100
1200X675	MC-353R1DT(HD)	100
1220X760	MC-354AR1C2(HD)	101
1500X600	MC-315RM5(HD)	101
1500X900	MC-355DIMR3(HD)	102
1520X900	MC-355DIFR5L(HD)	102
1800X900	MC-355-180/90DI(HD)	103
1800X600	MC-364-180X60C3(HD)	103

RECESSED TOP COVERS AND FRAMES

<u>CLEAR OPENING</u>	<u>CATALOGUE NO</u>	<u>PAGE NO</u>
400 sq	MC-216RC(LD)	107
400 sq	MC-216RC(MD)	107
400 sq	MC-216RC(HD)	107
400 sq	MC-217RCR3(HD)	107
400 sq	MC-218RCR1(LD)	108
400 sq	MC-225RCA DI(HD)	108
500 sq	MC-217 RC(LD)	109
500 sq	MC-217 RC(MD)	109
500 sq	MC-217 RC(HD)	109
600 sq	MC-218RCR2(LD)	109
600 dia	MC-219RCR(LD)	110
600 dia	MC-219RCR(MD)	110
600 dia	MC-219RCR(HD)	110
600 sq	MC-220RC(MD)	110
600 sq	MC-220RC(HD)	110
600 sq	MC-221RC(LD)	111
600 sq	MC-221RC(MD)	111
600 sq	MC-221RC(HD)	111
600 sq	MC-225RC(LD)	111
600 sq	MC-225RC(MD)	111
600 sq	MC-225RC(HD)	111
600 sq	MC-225RCBDI(HD)	112
600 sq	MC-225 RC DI(MD)	112
600 sq	MC-225 RC DI(HD)	112
700 sq	MC-230 RC(MD)	113
700 sq	MC-230 RC(HD)	113
800 dia	MC-218 RC R3(LD)	113
800 sq	MC-235 RC(MD)	114
800 sq	MC-235 RC(HD)	114
900 sq	MC-225 RC R DI(HD)	114
900 sq	MC-225 RC R3(LD)	115
900 sq	MC-225 RC R3(MD)	115
900 sq	MC-225 RC R3(HD)	115
1000 sq	MC-225 RC D DI(HD)	115
1000 sq	MC-225 RC R4(LD)	116
1000 sq	MC-225 RC R4(MD)	116
1000 sq	MC-225 RC R4(HD)	116
500X1000	MC-236 RC(MD)	116
500X1000	MC-236 RC(HD)	116
700X1000	MC-230 R C R3(MD)	117
700X1000	MC-230 R C R3(HD)	117
770X620	MC-226 R C R(HD)	117
750X1200	MC-230 R C R1(LD)	117
750X1200	MC-230 R C R1(MD)	117
750X1200	MC-230 R C R1(HD)	117

RECESSED TOP COVERS AND FRAMES

<u>CLEAR OPENING</u>	<u>CATALOGUE NO</u>	<u>PAGE NO</u>
1200x600	MC-120X60 RC C2(MD)	118
1200x600	MC-120X60 RC C2(HD)	118
1200X1200	MC-120X120 RC(MD)	118
1500X800	MC-150X80 RC C2(MD)	119
1500X800	MC-150X80 RC C2(HD)	119
1500X1200	MC-150X120 RC(MD)	119
1500X1200	MC-150X120 RC(HD)	119
1600X800	MC-231 R C R2(MD)	120
1600X800	MC-231 R C R2(HD)	120
1600X800	MC-160X80 RC C2(MD)	120
1600X800	MC-160X80 RC C2(HD)	120
1750X750	MC-230 RC R4 M(HD)	121
1750X750	MC-230 RC R4 M(MD)	121
1750X750	MC-230 RCR M2(MD)	121
1800X900	MC-237 R C3(MD)	121
1800X900	MC-237 R C3(HD)	121
1850X1500	MC-185X150 RC(HD)	122

COVERS WITH MILD STEEL ANGLE FRAMES

<u>CLEAR OPENING</u>	<u>CATALOGUE NO</u>	<u>PAGE NO</u>
500 sq	MC-50X50C1(LD)	125
575 sq	MC-66X66C1(LD)	125
600 sq	MC-60X60C1(LD)	126
600 sq	MC-60X70A-40(HD)	126
615 sq	MC-70X70C1(HD)	127
700 sq	MC-70X70C1(LD)	127
800 sq	MC-75X75C1(LD)	128
900 sq	MC-90X75C1(LD)	128
1000	MC-100X110A-40(HD)	128
1060 sq	MC-106X106C4 2X2(HD)	129
1200 sq	MC-120X120C4 2X2(HD)	129
1300 sq	MC-130X130C4 2X2(HD)	129
1360 sq	MC-136X136C4 2X2(HD)	129
1400 sq	MC-140X140C4 2X2(HD)	129
1500 sq	MC-150X150C4 2X2(HD)	129
2500 sq	MC-250X250C12 3X4(HD)	129
3000 sq	MC-300X300C12 3X4(HD)	129
600X750	MC-60X75C1(LD)	130
1146X900	MC-360C2(LD)	130
1146X900	MC-360C2(MD)	130
1146X900	MC-360C2(HD)	130
760X1150	MC-76X115C2(HD)	130

COVERS WITH MILD STEEL ANGLE FRAMES

CLEAR OPENING	CATALOGUE NO	PAGE NO
1000X1200	MC-100X120C2(HD)	130
1200X1000	MC-120X100C4 2X2(HD)	131
1200X1150	MC-361C4 2X2(HD)	131
1230X1080	MC-123X108C4 2X2(HD)	131
1300X1050	MC-130X105C4 2X2(HD)	131
1300X1200	MC-130X120C4(HD)	131
1400X1000	MC-140X100C4 2X2(HD)	131
1400X770	MC-354C3(HD)	131
1400X800	MC-140X80C2(HD)	132
1500X1200	MC-150X120C4 2X2(HD)	132
1600x1100	MC-160X110 C4 2X2(HD)	132
1600X1200	MC-160X120C4 2X2(HD)	132
1600X1720	MC-160X172C4 2X2(HD)	132
1800X600	MC-180X60C3/100(HD)	133
1800X900	MC-360C3(HD)	133
1800X900	MC-360C3(MD)	133
1900X1640	MC-190X164C6 2X3(HD)	134
2000X1600	MC-200X160C4 2X2(HD)	134
2000X900	MC-200X90 C6 2X3 (HD)	135
2000X1200	MC-200X120 C8 2X4 (HD)	135
2000X1400	MC-200X140 C8 2X4 (HD)	135
2450X1200	MC-245X120 C8 2X4 (HD)	135
2500X2000	MC-250X200C6 2X3 (HD)	136
2500X2000	MC-250X200 C12 3X4 (HD)	136
2800X1500	MC-280X150 C6 2X3 (HD)	137
2900X1500	MC-290X150 C6 2X3 (HD)	137
4000X1500	MC-400X150 C8 2X4 (HD)	137

GULLY GRATES

CLEAR OPENING	CATALOGUE NO	PAGE NO
140 dia	MC-481(HD)	141
225 sq	MC-442(LD)	141
225 sq	MC-442(MD)	141
225 sq	MC-442(HD)	141
280 dia	MC-440(LD)	142
295 sq	MC-443 SIPA	142
300 sq	MC-443(LD)	143
300 sq	MC-443(MD)	143
300 sq	MC-443(HD)	143
300 sq	MC-443MR2(MD)	143
300 sq	MC-443MR2(HD)	143
300 sq	MC-443 SO-75(HD)	143
300 sq	MC-443 SO-110(HD)	143

GULLY GRATES

CLEAR OPENING	CATALOGUE NO	PAGE NO
430 sq	MC-448HR6(LD)	144
430 sq	MC-448HR6(MD)	144
430 sq	MC-448HR6(HD)	144
450 sq	MC-450(MD)	144
450 sq	MC-450(HD)	144
500Sq	MC-452(HD)	144
450 sq	MC-450DT(HD)	145
450 sq	MC-450ADI(HD)	145
460 sq	MC-452AR1DT-DI(HD)	146
500 sq	MC-452DT(HD)	146
500 sq	MC-451DI (MD)	147
500 sq	MC-451DI(HD)	147
550 sq	MC-455(MD)	147
550 sq	MC-455(HD)	147
600 dia	MC-441(LD)	148
600 dia	MC-441(MD)	148
600 dia	MC-441(HD)	148
600 dia	MC-441SQFR1(HD)	148
600 sq	MC-451A1DI(HD)	149
600 sq	MC-451A3DI(HD)	149
600 sq	MC-460(LD)	149
600 sq	MC-460(MD)	149
600sq	MC-460(HD)	149
600 sq	MC-460A(HD)	149
600 sq	MC-460AR2(HD)	149
640Sq	MC-461(HD)	149
600 sq	MC-460MT(HD)	150
600 sq	MC-470MT(HD)	150
600 sq	MC-470(HD)	151
600 sq	MC-470R1(HD)	151
600 sq	MC-470R2(HD)	151
700 sq	MC-471R1DI(HD)	152
750 sq	MC-475(MD)	152
750 sq	MC-475(HD)	152
800 sq	MC-476(HD)	153
900 sq	MC-477R5A(HD)	153
900 sq	MC-476R1N(HD)	154
1000 sq	MC-478G-RO(MD)	154
1000 sq	MC-476ADI(HD)	155
1200 sq	MC-476AR1N(HD)	155
1270 sq	MC-476AR2N(HD)	156
210X400	MC-450RDI(HD)	156
300X300	MC-443DT(HD)	157
310X380	MC-491B(MD)	157
310X380	MC-491B(HD)	157

GULLY GRATES

<u>CLEAR OPENING</u>	<u>CATALOGUE NO</u>	<u>PAGE NO</u>
317X385	MC-491A(MD)	158
317X385	MC-491A(HD)	158
320X210	MC-480(MD)	158
320X210	MC-480A(MD)	159
320X210	MC-480A(HD)	159
320X210	MC-480B(HD)	159
370X435	MC-491C(MD)	160
370X435	MC-491C(HD)	160
395X440	MC-491D(MD)	160
395X440	MC-491D(HD)	160
400X500	MC-481RD(MD)	161
400X500	MC-481RD(HD)	161
410X300	MC-481(MD)	161
425X275	MC-446SIPA	162
430X370	MC480(HD)	162
430X370	MC-480DI(HD)	163
450X400	MC-480RD(HD)	163
450X240	RF-CG-485	163
495X345	MC-495X345(HD)	164
500X150	KGG-50X15(HD)	164
500X150	RF-CG-484	165
510X340	MC-490KB(HD)	165
540X450	MC-483KBG(HD)	166
563X150	KGG563X150X110(HD)	166
580X880	MC-479(HD)	167
600X600	MC-443ADT(HD)	167
600X900	MC-457DI(HD)	168
600X530	MC-465(HD)	168
600X520	MC-477(HD)	169
600X450	MC-480R1DI(HD)	169
600X530	MC-475KB(HD)	170
625X325	MC-445R1SIPA	170
625X750	MC-472R1A(HD)	171
900X600	MC465AR5/40 (HD)	171
900X600	MC466AR5HD	171
905X450	MC-480KB-R2(HD)	172
1000X450	MC-485R1G(MD)	172
1000X450	MC-485R1G(HD)	172
1000X750	MC-100X75 G2 (HD)	173
1010X450	MC-485(HD)	173
1200X600	MC-485MT(MD)	174
1200X600	MC-485MT(HD)	174
1200X600	MC-485DHD(HD)	174
1200X600	MC-120X60 G2 (HD)	175
1200X1200	MC-120X120DIG2M40HD	175

GULLY GRATES

<u>CLEAR OPENING</u>	<u>CATALOGUE NO</u>	<u>PAGE NO</u>
1400X1400	MC-140X140 G4(HD)	176
1500X1500	MC-150X150 G4(HD)	176
1500X1500	MC-150X150DIG4(HD)	177
1600X1370	MC-160X137 G6(HD)	177
2000X1500	MC-200X150 G6(HD)	177
2460X1460	MC-260X160 G6(HD)	177
2500X1500	MC-250X150 G6(HD)	177
3000X1750	MC-300X175G6(HD)	177

CHANNEL GRATES

<u>CLEAR OPENING</u>	<u>CATALOGUE NO</u>	<u>PAGE NO</u>
150	MC-500AR4(HD)	183
150	MC-516 E DI(HD)	183
150	MC-516 R2DI(HD)(60 TONS)	184
150	MC-516 R2DI(HD)(90 TONS)	184
150	MC-490 G(HD)	184
250	MC-500(LD)	185
250	MC-500(MD)	185
250	MC-500(HD)	185
250	MC-500 EDI(HD)	185
265	MC-500 R6 DI(MD)	186
265	MC-500 R6 DI(HD)	186
300	MC-500 R1(LD)	186
300	MC-500 R1(MD)	186
300	MC-500 R1(HD)	186
300	MC-500 R2MDI(HD)	187
300	MC-500 R2DI(HD)	187
300	MC-500 R1DI(HD)	187
300	MC-500 EDI(HD)	187
350	MC-501(LD)	188
350	MC-501(MD)	188
350	MC-501(HD)	188
400	MC-510 R3DI(MD)	188
400	MC-510 R3DI(HD)	188
400	MC-510(LD)	189
400	MC-510(MD)	189
400	MC-510(HD)	189
500	MC-511(LD)	189
500	MC-511(MD)	189
500	MC-511(HD)	189
500	MC-511 AR3(MD)	189
600	MC-512(LD)	190
600	MC-512(MD)	190

CHANNEL GRATES

<u>CLEAR OPENING</u>	<u>CATALOGUE NO</u>	<u>PAGE NO</u>
600	MC-512(HD)	190
600	MC-900 G(HD)	190
615	MC-901 DIG(HD)	191
800	MC-900 G5(HD)	191
125X651	MC-500 FDI (HD)	192
150	MC-515(LD)	192
150	MC-515(MD)	192
150	MC-515(HD)	192
200	MC-516(LD)	193
200	MC-516(MD)	193
200	MC-516(HD)	193
200	MC-515A(LD)	193
250	MC-517(LD)	194
250	MC-517(MD)	194
250	MC-517(HD)	194
250	MC-515 B(LD)	194
300	MC-515 C(LD)	195
300	MC-520 (LD)	195
300	MC-520(MD)	195
300	MC-520(HD)	195
335	MC-517RD 50(HD)	196
350	MC-515D(LD)	196
400	MC-521(LD)	197
400	MC-521(MD)	197
400	MC-521(HD)	197
500	MC-525(LD)	197
500	MC-525(MD)	197
500	MC-525(HD)	197
600	MC-526(LD)	198
600	MC-526(MD)	198
600	MC-526(HD)	198

TREE GRATES

<u>CLEAR OPENING</u>	<u>CATALOGUE NO</u>	<u>PAGE NO</u>
320 sq	TG-570	201
350 dia	TG-555	201
450 dia	TG-559 R2	202
500 dia	TG-555 R1	202
500 sq	TG-553 SQ/50	203
500 dia	TG-560 R1	203
600 sq	TG-550 R5	204
600 dia	TG-557 R2	204
700 dia	TG-550/120 DI	205

TREE GRATES

<u>CLEAR OPENING</u>	<u>CATALOGUE NO</u>	<u>PAGE NO</u>
700 sq	TG-550	205
700 dia	TG-560	206
700 dia	TG-564 R3	206
900 dia	TG-557 R3	207
900 dia	TG-560 R3	207
950 dia	TG-556	208
950 dia	TG-559 R1	208
1000 sq	TG-550 R4	209
1000 dia	TG-560 R4	209

SURFACE BOX

<u>CLEAR OPENING</u>	<u>CATALOGUE NO</u>	<u>PAGE NO</u>
120 dia	SB-600 (HD)	213
120 dia	SB-600 DI (HD)	213
125 sq	SB-640 DT(HD)	214
140 dia	SB-615 (HD)	214
140 dia	SB-620 R3(HD)	215
140 dia	SB-609 (HD)	215
150 dia	SB-610 (HD)	215
150 sq	SB-640 DTA(HD)	216
150 sq	SB-640 DT D1(HD)	216
160 dia	SB-615 R2(HD)	217
190 dia	SB-620 (HD)	217
190 dia	SB-620 R(HD)	218
200 dia	RF-VD-200 R1	218
200 dia	SB-616 (HD)	219
200 dia	SB-630 (HD)	219
250 sq	SB-640 (HD)	220
280 dia	SB-636 (HD)	220
280 dia	SB-631 R1DI(HD)	221
290 dia	SB-631 (HD)	221
300 dia	SB-621 (HD)	222
300 dia	SB-620 R1(HD)	222
300 sq	SB-640 DTB(HD)	223
300 sq	SB-650 A(HD)	223
325 sq	SB-645 (HD)	224
325 sq	SB-645 DI(HD)	224
380X325	SB-646 (HD)	225
380X325	SB-646 DI(HD)	225

WATER METER BOX

<u>CLEAR OPENING</u>	<u>CATALOGUE NO</u>	<u>PAGE NO</u>
335X325	WM-704	229
405X197	WM-701 A	229
405X200	WM-703	230
450X250	WM-705	230
767X425	WM-702	231
900X350	WM-701	231
900X395	WM-700	232

SAUDI ARAMCO

<u>CLEAR OPENING</u>	<u>CATALOGUE NO</u>	<u>PAGE NO</u>
600 dia	MC-110 R(HD)	235
600 dia	MC-110 R2(HD)	235
622 dia	MC-125 (HD)	236
760 dia	MC-170 R(HD)	236
	CATCH BASIN C" 10"	237
	CATCH BASIN A" 6"	237
	CATCH BASIN C" 6"	238
	CATCH BASIN C" 8"	238
	CATCH BASIN B" 6"	239

TELECOMMUNICATION

<u>CLEAR OPENING</u>	<u>CATALOGUE NO</u>	<u>PAGE NO</u>
595 dia	MC-115 R3N(HD)	243
595 sq	MC-680X680 C1(LD)	243
595 sq	MC-680X680 C1(MD)	243
595 sq	MC-680X680 C1(HD)	243
600 sq	MC-684X684 C1(LD)	244
600 sq	MC-684X684 C1(MD)	244
600 sq	MC-684X684 C1(HD)	244
605 sq	MC-690X690 C1(LD)	244
605 sq	MC-690X690 C1(MD)	244
605 sq	MC-690X690 C1(HD)	244
680 dia	MC-120 A(HD)	245
690 dia	MC-120 A4(HD)	245
580X480	MC-350 C1(LD)	246
580X480	MC-350 C1(MD)	246
580X480	MC-350 C1(HD)	246
646X646	MC-646X646 C1 (HD)	246
1100X580	MC-350 C2(LD)	247
1100X580	MC-350 C2(MD)	247

TELECOMMUNICATION

<u>CLEAR OPENING</u>	<u>CATALOGUE NO</u>	<u>PAGE NO</u>
1100X580	MC-350 C2(HD)	247
1223X560	MC-646X646 C2(HD)	247
1290X595	MC-680X680 C2(LD)	248
1290X595	MC-680X680 C2(MD)	248
1290X595	MC-680X680 C2(HD)	248
1300X600	MC-684X684 C2(LD)	248
1300X600	MC-684X684 C2(MD)	248
1300X600	MC-684X684 C2(HD)	248
1310X605	MC-690X690 C2(LD)	248
1310X605	MC-690X690 C2(MD)	248
1310X605	MC-690X690 C2(HD)	248
1720X580	MC-350 C3(LD)	249
1720X580	MC-350 C3(MD)	249
1720X580	MC-350 C3(HD)	249
1985X595	MC-680X680 C3(LD)	250
1985X595	MC-680X680 C3(MD)	250
1985X595	MC-680X680 C3(HD)	250
2000X600	MC-684X684 C3(LD)	250
2000X600	MC-684X684 C3(MD)	250
2000X600	MC-684X684 C3(HD)	250
2015X605	MC-690X690 C3(LD)	250
2015X605	MC-690X690 C3(MD)	250
2015X605	MC-690X690 C3(HD)	250
615X615	MC-700X700 C1 (HD)	251
1990X615	MC-700X700 C2 (HD)	251
1000X900	MC-100X90 C2 JTC (MD)	252
1000X900	MC-100X90 C2 JTC (HD)	252
1550X900	MC-155X90 JTC C3 (MD)	252
1550X900	MC-155X90 JTC C3 (HD)	252
760	MC-120 JTC DI (HD)	253
577X377	MC-68X48 C1 JTC (HD)	253
577X377	MC-68X48 C1 JTC (MD)	253

TELECOMMUNICATIONS ACCESSORIES

LADDER SUPPORT	254
SUMP PIT COVERS	254
PULLING EYES	254
BONDING RIBBON	254
MARKING PLATE	254
ANCHOR BOLT	254
CABLE BRACKET SUPPORTS	255
HOOK LADDER	256
BRONZE PLAQUE	257

MINISTRY OF WATER AND ELECTRICITY

<u>CLEAR OPENING</u>	<u>CATALOGUE NO</u>	<u>PAGE NO</u>
120 dia	SB-600 (HD)	261
140 dia	SB-620 R3(HD)	261
120 dia	SB-600 (HD)	262
280 dia	SB-631 R1(HD)	262
300 dia	SB-621 (HD)	263
330 dia	SB-631 AR1(HD)	263
600 dia	MC-105(MD)	264
600 dia	MC-115(HD)	264
600 dia	MC-105 (HD)	265
600 dia	MC-110 (HD)	265
600 dia	MC-115 (HD)	266
1200X600	MC-354 (HD)	266
1800X600	MC-180X60 C3(HD)	267

MINISTRY OF WATER AND MUNICIPALITY

<u>CLEAR OPENING</u>	<u>CATALOGUE NO</u>	<u>PAGE NO</u>
600 dia	MC-115 (HD)	271
600X530	MC-475 R1M(HD)	271
1200X600	MC-315 RM4(HD)	272
1200X1200	MC-120X120 DIG2M40HD/70	272
1500X600	MC-315 RM5(HD)	273
1500X1500	MC-150X150 DI G4(HD)	273

MINISTRY OF EDUCATION

BOYS SCHOOL

<u>CLEAR OPENING</u>	<u>CATALOGUE NO</u>	<u>PAGE NO</u>
300 dia	MC-203 (LD)	277
300 sq	MC-203 R4 (LD)	277
600 dia	MC-118 (MD)	278
600 sq	MC-210 SG R2 (LD)	278
SCUPPER DRAIN		279
ROOF DRAIN		279
FLOOR DRAIN		280
CLEAN OUT		280

GIRLS SCHOOL

250 sq	MC-200 R (LD)	281
300 sq	MC-443 (MD)	281
415 dia	MC-171 (LD)	282
600 sq	MC-210 SG R2(MD)	282
SCUPPER DRAIN		283

MINISTRY OF EDUCATION

GIRLS SCHOOL

<u>CLEAR OPENING</u>	<u>PAGE NO</u>
ROOF DRAIN	283
FLOOR DRAIN	284
MILD STEEL BRACKET TYPE ACCESS LADDER	284

DRAINAGE PRODUCTS

<u>CLEAR OPENING</u>	<u>PAGE NO</u>
ROOF DRAIN	287
FLOOR DRAIN	289
SCUPPER DRAIN	293
SLOPING GRATE	294
HOODED VENT CAP	296
GUTTER DRAIN	296
CLEAN OUT	298

STEEL FABRICATED PRODUCTS LADDERS, STEP ETC

MANHOLE ACCESSORIES

ACCESS LADDER	303
MANHOLE STEP	306

<u>CLEAR OPENING</u>	<u>CATALOGUE NO</u>	<u>PAGE NO</u>
250	RF-CK-F-250	312
300	RF-CK-F-300	312
400	RF-CK-F-400	312
500	RF-CK-F-500	312
600	RF-CK-F-600	312
750	RF-CK-F-750	312
1000	RF-CK-F-1000	312
300X300	RF-ST-30X30	313
400X400	RF-ST-40X40	313
500X500	RF-ST-50X50	313
600X450	RF-ST-60X45	313
600X600	RF-ST-60X60	313
900X600	RF-ST-90X60	313
900X900	RF-ST-90X90	313
500X500	RF-HC-50X50	313
600X600	RF-HC-60X60	313
700X700	RF-HC-70X70	313
1200X1200	RF-HC-120X120	313
600X600	MC-60X60 C2 SL	314
1000X1000	MC-100X100 C2 SL	314

STEEL FABRICATED PRODUCTS
LADDERS, STEP ETC

CLEAR OPENING	CATALOGUE NO	PAGE NO
1200X600	MC-120X60 C2 SL	314
1000X500	RF-HC 100X50	314
1000X600	RF-HC 100X60	314
1000X750	RF-HC 100X75	314
1200X600	RF-HC 120X60	314
1200X1000	RF-HC 120X100	314

MILD STEEL PRODUCTS
RECESSED TOP SINGLE TRENCH

CLEAR OPENING	CATALOGUE NO	PAGE NO
200X200	RF-SRC-20X20	315
300X300	RF-SRC-30X30	315
400X400	RF-SRC-40X40	315
500X500	RF-SRC-50X50	315
600X450	RF-SRC-60X45	315
600X600	RF-SRC-60X60	315
700X700	RF-SRC-70X70	315
800X800	RF-SRC-80X80	315
900X600	RF-SRC-90X60	315
900X900	RF-SRC-90X90	315
1000X1000	RF-SRC-100X100	315

MULTIPLE SOLID TOP MILD STEEL
COVER AND FRAME

CLEAR OPENING	CATALOGUE NO	PAGE NO
1000X1000	RF-AC-1000	316
1500X1500	RF-AC-1500	316
2000X2000	RF-AC-2000	316

MILD STEEL TRENCH GRATES
AND FRAME

CLEAR OPENING	CATALOGUE NO	PAGE NO
300X300	RF-MSG-F 30X30	317
400X400	RF-MSG-F 40X40	317
500X500	RF-MSG-F 50X50	317
600X450	RF-MSG-F 60X45	317
600X600	RF-MSG-F 60X60	317
750X600	RF-MSG – 75X60	317

MINISTRY OF EDUCATION

CLEAR OPENING	CATALOGUE NO	PAGE NO
750X750	RF-MSG-F 75X75	317
800X800	RF-MSG-F 80X80	317
900X600	RF-MSG-F 90X60	317
900X900	RF-MSG-F 90X90	317
1000X1000	RF-MSG-F 100X100	317